

Lay-in duct, screwed cover

- Quick Features :**
- Rounded corners
 - Complete system
 - Powder coating



Visit www.eurobex.com for details.

Call us toll free 1-800-363-2423

The 1100 series lay-in ducts are made of code gauge steel and designed to permit fast and easy installation of multiple wire runs. The corners of components are rounded. The covers are secured by screws. Knockouts are provided on two sides of the body. Also available without knockouts

(add suffix "N" to the catalog number). All accessories for a complete system such as 22½°, 45° and 90° elbows, crosses, T's, reducers, telescope fittings have removable covers. Joiner plates are linked by carriage bolts and anti-vibration nuts which can be installed using minimum tooling.

All of the painted components are finished with heat fused polyester powder, electrostatically applied on a phosphatized base. Finish is ANSI/ASA 61 gray. (other colors available)

**CSA Certified
NEMA 1 / IP20**

| DESCRIPTION | CATALOG NUMBER | | | | | |
|----------------------------|----------------|---------------|---------------|---------------|----------------|----------------|
| | 2½" X 2½" | 4" X 4" | 6" X 6" | 8" X 8" | 10" X 10" | 12" X 12" |
| Straight sections 12" | 1100 SS2012SC | 1100 SS4012SC | 1100 SS6012SC | 1100 SS8012SC | 1100 SS10012SC | 1100 SS12012SC |
| Straight sections 24" | 1100 SS2024SC | 1100 SS4024SC | 1100 SS6024SC | 1100 SS8024SC | 1100 SS10024SC | 1100 SS12024SC |
| Straight sections 36" | 1100 SS2036SC | 1100 SS4036SC | 1100 SS6036SC | 1100 SS8036SC | 1100 SS10036SC | 1100 SS12036SC |
| Straight sections 48" | 1100 SS2048SC | 1100 SS4048SC | 1100 SS6048SC | 1100 SS8048SC | 1100 SS10048SC | 1100 SS12048SC |
| Straight sections 60" | 1100 SS2060SC | 1100 SS4060SC | 1100 SS6060SC | 1100 SS8060SC | 1100 SS10060SC | 1100 SS12060SC |
| Straight sections 72" | 1100 SS2072SC | 1100 SS4072SC | 1100 SS6072SC | 1100 SS8072SC | 1100 SS10072SC | 1100 SS12072SC |
| Straight sections 120" | 1100 SS2120SC | 1100 SS4120 | 1100 SS6120 | 1100 SS8120 | 1100 SS10120 | 1100 SS12120 |
| Screw on barrier 12" | 1100 BA2012 | 1100 BA4012 | 1100 BA6012 | 1100 BA8012 | 1100 BA10012 | 1100 BA12012 |
| Screw on barrier 24" | 1100 BA2024 | 1100 BA4024 | 1100 BA6024 | 1100 BA8024 | 1100 BA10024 | 1100 BA12024 |
| Screw on barrier 36" | 1100 BA2036 | 1100 BA4036 | 1100 BA6036 | 1100 BA8036 | 1100 BA10036 | 1100 BA12036 |
| Screw on barrier 48" | 1100 BA2048 | 1100 BA4048 | 1100 BA6048 | 1100 BA8048 | 1100 BA10048 | 1100 BA12048 |
| Screw on barrier 60" | 1100 BA2060 | 1100 BA4060 | 1100 BA6060 | 1100 BA8060 | 1100 BA10060 | 1100 BA12060 |
| Screw on barrier 72" | -- | 1100 BA4072 | 1100 BA6072 | 1100 BA8072 | -- | -- |
| Screw on barrier 120" | 1100 BA2120 | 1100 BA4120 | 1100 BA6120 | 1100 BA8120 | 1100 BA10120 | 1100 BA12120 |
| Telescope fitting | 1100 TL2068 | 1100 TL4068 | 1100 TL6068 | 1100 TL8068 | 1100 TL10068 | 1100 TL12068 |
| Elbow 90 degrees | 1100 EL2090 | 1100 EL4090 | 1100 EL6090 | 1100 EL8090 | 1100 EL10090 | 1100 EL12090 |
| Elbow 45 degrees | 1100 EL2045 | 1100 EL4045 | 1100 EL6045 | 1100 EL8045 | 1100 EL10045 | 1100 EL12045 |
| Elbow 22½ degrees | 1100 EL2022 | 1100 EL4022 | 1100 EL6022 | 1100 EL8022 | 1100 EL10022 | 1100 EL12022 |
| Elbow sweep 90 degrees | 1100 ES2091 | 1100 ES4091 | 1100 ES6091 | 1100 ES8091 | -- | -- |
| Tee fitting | 1100 TF2062 | 1100 TF4062 | 1100 TF6062 | 1100 TF8062 | 1100 TF10062 | 1100 TF12062 |
| Cross fitting | 1100 CF2063 | 1100 CF4063 | 1100 CF6063 | 1100 CF8063 | 1100 CF10063 | 1100 CF12063 |
| Reducer 4"X4" to 2½"X2½" | -- | 1100 RD4402 | -- | -- | -- | -- |
| Reducer 6"X6" to 4"X4" | -- | -- | 1100 RD6604 | -- | -- | -- |
| Reducer 8"X8" to 6"X6" | -- | -- | -- | 1100 RD8806 | -- | -- |
| Reducer 10"X10" to 8"X8" | -- | -- | -- | -- | 1100 RD101008 | -- |
| Reducer 12"X12" to 8"X8" | -- | -- | -- | -- | -- | 1100 RD121208 |
| Reducer 12"X12" to 10"X10" | -- | -- | -- | -- | -- | 1100 RD121210 |
| Joiner (Coupling) | 1100 JO2067 | 1100 JO4067 | 1100 JO6067 | 1100 JO8067 | 1100 JO10067 | 1100 JO12067 |
| Bracket hanger | 1100 HD2069 | 1100 HD4069 | 1100 HD6069 | 1100 HD8069 | 1100 HD10069 | 1100 HD12069 |
| Drop hanger | 1100 HD2069 | 1100 HD4069 | 1100 HD6069 | 1100 HD8069 | 1100 HD10069 | 1100 HD12069 |
| Support hanger | 1100 HS2070 | 1100 HS4070 | 1100 HS6070 | 1100 HS8070 | 1100 HS10070 | 1100 HS12070 |
| Closing plate | 1100 CP2065 | 1100 CP4065 | 1100 CP6065 | 1100 CP8065 | 1100 CP10065 | 1100 CP12065 |
| Open adaptor | 1100 OA2071 | 1100 OA4071 | 1100 OA6071 | 1100 OA8071 | 1100 OA10071 | 1100 OA12071 |
| Adaptor (Box connector) | 1100 AD2066 | 1100 AD4066 | 1100 AD6066 | 1100 AD8066 | 1100 AD10066 | 1100 AD12066 |

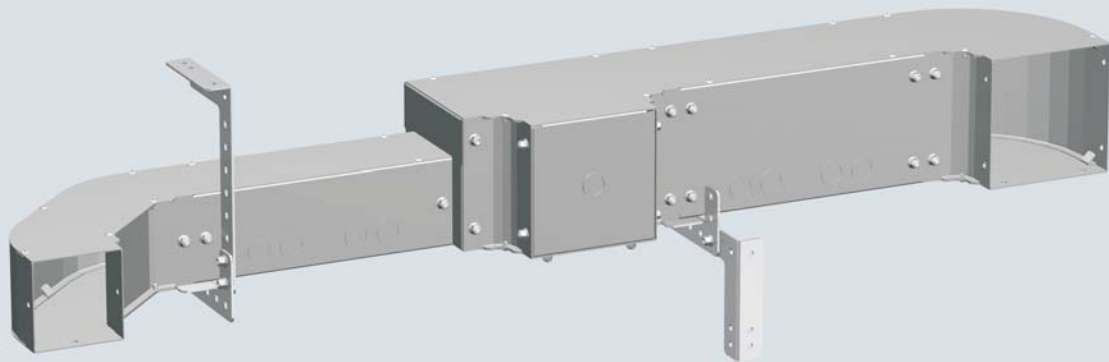

Data subject to change without notice.

Suggested Accessories



p.368

NEMA 1 WIREWAY

1100 DUCTS

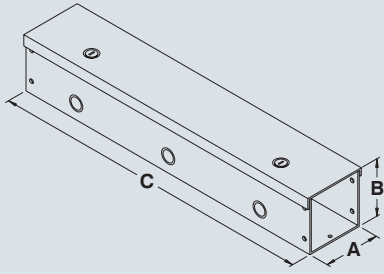

Straight section

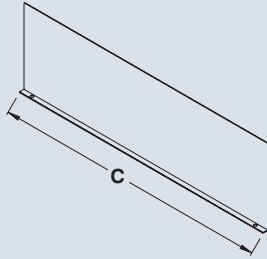

Screw-on barrier

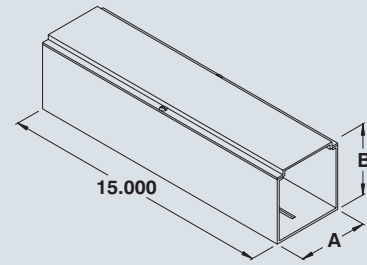

Telescope fitting

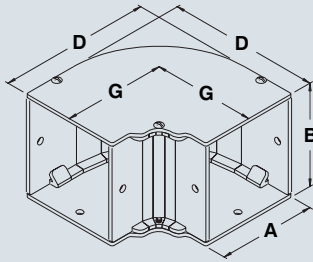

Elbow 90 degrees

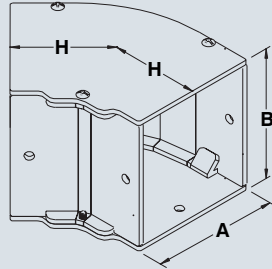

Elbow 45 degrees

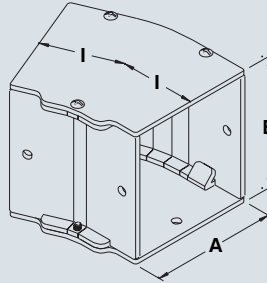

Elbow 22½ degrees

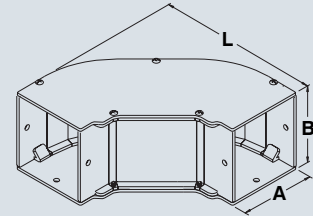

Elbow sweep 90 degrees

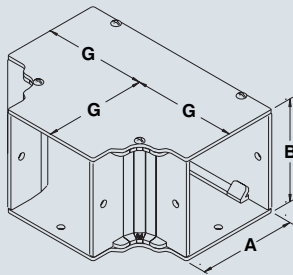

Tee fitting

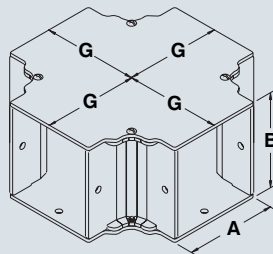

Cross fitting

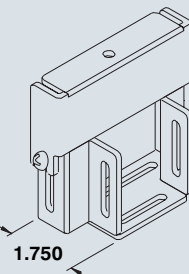

Reducer

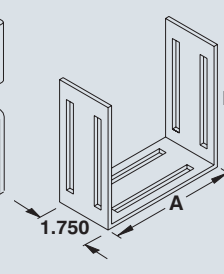

Joiner plate

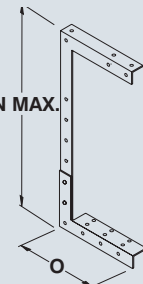

Bracket Hanger

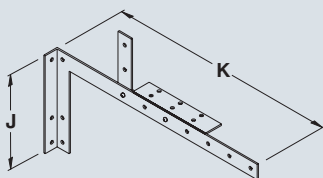

Drop hanger

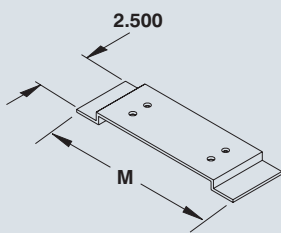

Support hanger

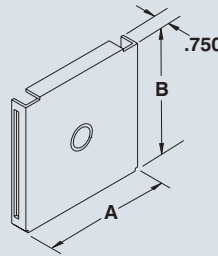

Closing plate

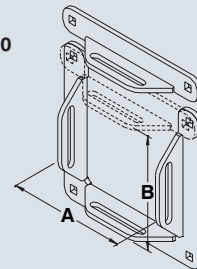

Open Adaptor

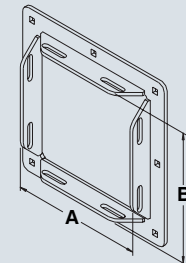

Adaptor

DIMENSIONS

| A | B | C | D | F | G | H | I | J | K | L | M | N | O |
|--------|--------|-----------------------|--------|-------|-------|-------|-------|-------|--------|--------|--------|--------|--------|
| 2.500 | 2.500 | 12-24-36-48-60-72-120 | 4.687 | 2.500 | 3.437 | 2.500 | 2.250 | 4.000 | 7.000 | 7.906 | 4.500 | 12.000 | 4.750 |
| 4.000 | 4.000 | 12-24-36-48-60-72-120 | 6.187 | 2.656 | 4.187 | 2.812 | 2.406 | 6.000 | 8.500 | 9.406 | 6.000 | 15.000 | 6.250 |
| 6.000 | 6.000 | 12-24-36-48-60-72-120 | 8.187 | 3.312 | 5.187 | 3.250 | 2.406 | 8.000 | 10.500 | 11.406 | 8.000 | 19.000 | 8.250 |
| 8.000 | 8.000 | 12-24-36-48-60-72-120 | 10.187 | 3.656 | 6.187 | 3.656 | 2.750 | 8.000 | 12.500 | 13.406 | 10.000 | 23.000 | 10.250 |
| 10.000 | 10.000 | 12-24-36-48-60-72-120 | 12.187 | 4.000 | 7.187 | 4.062 | 3.000 | 8.000 | 14.500 | 15.406 | 12.000 | 27.000 | 12.250 |
| 12.000 | 12.000 | 12-24-36-48-60-72-120 | 14.187 | 4.625 | 8.187 | 4.500 | 3.187 | 8.000 | 16.500 | 17.406 | 14.000 | 31.000 | 14.250 |

Data subject to change without notice.

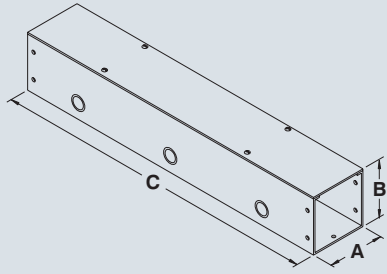

Straight section

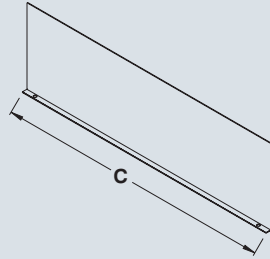

Screw-on barrier

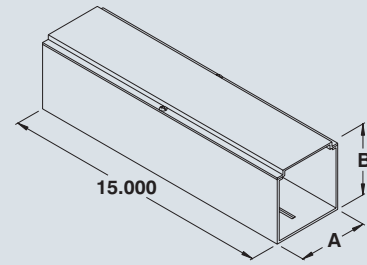

Telescope fitting

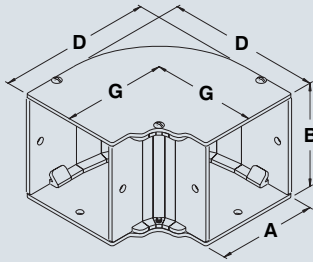

Elbow 90 degrees

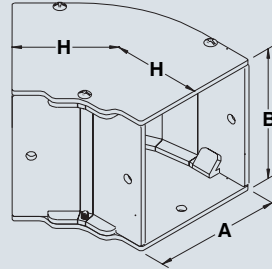

Elbow 45 degrees

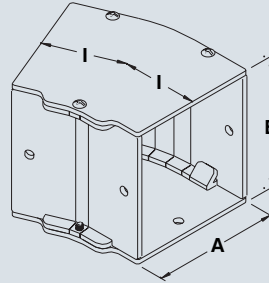

Elbow 22½ degrees

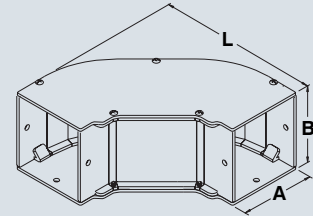

Elbow sweep 90 degrees

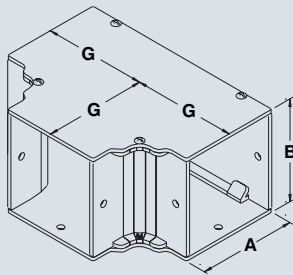

Tee fitting

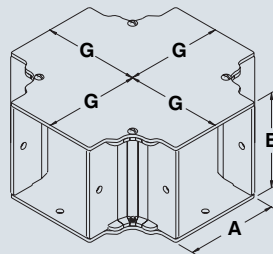

Cross fitting

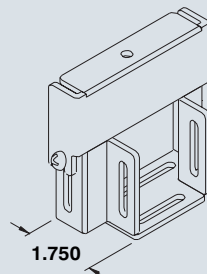

Reducer

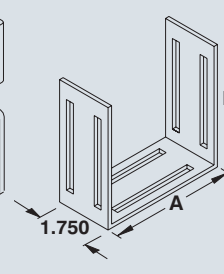

Joiner plate

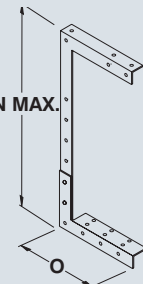

Bracket Hanger

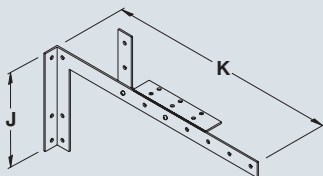

Drop hanger

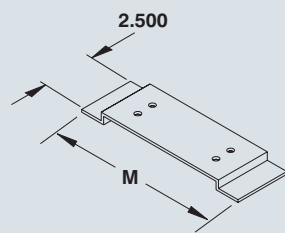

Support hanger

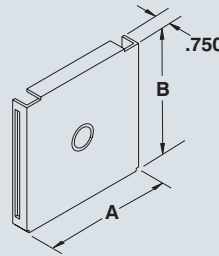

Closing plate

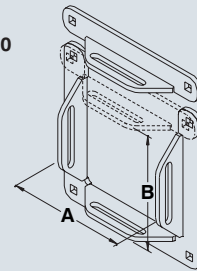

Open Adaptor

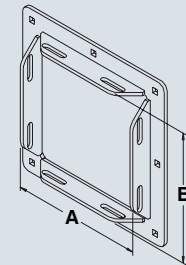

Adaptor

DIMENSIONS

| A | B | C | D | F | G | H | I | J | K | L | M | N | O |
|--------|--------|-----------------------|--------|-------|-------|-------|-------|-------|--------|--------|--------|--------|--------|
| 2.500 | 2.500 | 12-24-36-48-60-72-120 | 4.687 | 2.500 | 3.437 | 2.500 | 2.250 | 4.000 | 7.000 | 7.906 | 4.500 | 12.000 | 4.750 |
| 4.000 | 4.000 | 12-24-36-48-60-72-120 | 6.187 | 2.656 | 4.187 | 2.812 | 2.406 | 6.000 | 8.500 | 9.406 | 6.000 | 15.000 | 6.250 |
| 6.000 | 6.000 | 12-24-36-48-60-72-120 | 8.187 | 3.312 | 5.187 | 3.250 | 2.406 | 8.000 | 10.500 | 11.406 | 8.000 | 19.000 | 8.250 |
| 8.000 | 8.000 | 12-24-36-48-60-72-120 | 10.187 | 3.656 | 6.187 | 3.656 | 2.750 | 8.000 | 12.500 | 13.406 | 10.000 | 23.000 | 10.250 |
| 10.000 | 10.000 | 12-24-36-48-60-72-120 | 12.187 | 4.000 | 7.187 | 4.062 | 3.000 | 8.000 | 14.500 | 15.406 | 12.000 | 27.000 | 12.250 |
| 12.000 | 12.000 | 12-24-36-48-60-72-120 | 14.187 | 4.625 | 8.187 | 4.500 | 3.187 | 8.000 | 16.500 | 17.406 | 14.000 | 31.000 | 14.250 |

Data subject to change without notice.