

SIEMENS



SINAMICS V20

The cost-effective, reliable and easy-to-use
AC drive for basic applications

usa.siemens.com/sinamics-v20

Answers for industry.

SINAMICS V20

The perfect drive solution for basic applications

SINAMICS V20, the versatile drive system for basic demands

Today, in an increasing number of applications in plant and machinery construction, individual automation and drive solutions are demanded that automate simple motion sequences with low associated requirements.

With its compact SINAMICS V20, the basic performance AC drive, Siemens offers a simple and cost-effective drive solution for these types of applications. SINAMICS V20 sets itself apart with its quick commissioning times, ease of operation, robustness and cost-efficiency.

With four frame sizes, it covers a power range extending from 0.12 kW up to 15 kW (1/6 hp up to 20 hp).

Minimize your costs

Engineering, commissioning and operating costs as well as those in operation must be kept as low as possible. You have precisely the right answer with our SINAMICS V20. To increase energy efficiency, the drive is equipped with a control technique to achieve optimum energy efficiency through automatic flux reduction. Not only this, it displays the actual energy consumption and has additional, integrated energy-saving functions. This allows energy consumption to be slashed drastically.

Highlights

Easy-to-install

- Push-through and wall mounting – side-by-side possible for both
- USS and Modbus RTU at terminals
- Integrated braking chopper for 7.5 kW to 15 kW (10 hp up to 20 hp)

Easy-to-use

- Parameter loading without power supply
- Integrated application and connection macros
- Keep Running Mode for uninterrupted operation
- Wide voltage range, advanced cooling design and coated PCBs increase robustness

Easy to save money

- ECO mode for V/f, V²/f
- Hibernation mode
- DC coupling

Power range	0.12 kW to 15 kW (1/6 hp up to 20 hp)
Voltage range	1AC 200 V ... 240 V (+ / -10 %) 3AC 380 V ... 480 V (+10 % / -15 %)
Control modes	V/f V ² /f FCC V/f multi-point



Typical applications

Pumping, ventilating and compressing		
	<ul style="list-style-type: none"> • Centrifugal pumps • Radial/axial fans • Compressors 	<p>Additional advantages:</p> <ul style="list-style-type: none"> • High availability through automatic restart and flying restart after power failures • Broken belt detection by monitoring the load torque • Pump protection against cavitation • Hammer start and blockage clearing modes for clogged pumps • PID controller for process values (e.g. temperature, pressure, level, flow) • PID auto tuning to optimize controller parameters • Hibernation mode stops the motor when demand is low • Motor staging extends the flow range by adding two more fixed-speed drives (cascade) • Frost and condensation protection prevents moisture in motors under extreme environmental conditions
Moving		
	<ul style="list-style-type: none"> • Belt conveyors • Roller conveyors • Chain conveyors 	<p>Additional advantages:</p> <ul style="list-style-type: none"> • Soft, jerk-free acceleration reduces the stress on the gear units, bearings, drums and rollers • Super torque start for conveyor belts with high breakaway torque • Dynamic behavior by using braking resistor or DC braking • Direct control of mechanical holding brake • Broken belt detection by monitoring the load torque
Processing		
	<ul style="list-style-type: none"> • Single drives in the process industry such as mills, mixers, kneaders, crushers, agitators, centrifuges • Main drives in machines with mechanically coupled axes such as ring spinning machines, braiding machines for textile, ropes and wire 	<p>Additional advantages:</p> <ul style="list-style-type: none"> • Frost and condensation protection prevents moisture in motors under extreme environmental conditions • Higher productivity with uninterrupted production due to Keep Running Mode • Exchange of regenerative energy via the DC link • Super torque start for machines with a high breakaway torque

Easy-to-install



Installation		
	SINAMICS V20 feature	Your benefits
<p>Side-by-side mounting No space required</p> <p>Wall mounting Cooling</p> <p>Push-through mounting Cooling</p>	<p>Compact design, side-by-side mounting and flexible device installation for both wall mounting and push-through mounting.</p> <p>Operation without additional option modules possible.</p>	<ul style="list-style-type: none"> • Compact installation allows smaller cabinets to be used • Push-through mounting allows the cabinet to be cooled more easily • Can be run "out-of-the-box" without other options • Basic operator actions at a built-in BOP (Basic Operator Panel)

Communication		
	SINAMICS V20 feature	Your benefits
<p>Siemens products Standard library USS</p> <p>Other products Modbus</p> <p>SINAMICS V20</p>	<p>The communication port is available at the terminals. The preset parameters of the USS and Modbus RTU are defined in the connection macro.</p>	<ul style="list-style-type: none"> • Easy integration into existing systems • Easy integration into micro automation systems • Easier commissioning through standard libraries and connection macros

Braking module		
	SINAMICS V20 feature	Your benefits
<p>SINAMICS V20</p> <p>Motor</p> <p>Braking module</p> <p>Resistor</p>	<p>The dynamic energy is dissipated as heat in a braking resistor with an adjustable duty cycle of between 5 % and 100 %.</p>	<ul style="list-style-type: none"> • Possible to use dynamic braking to increase braking performance • Drives ≥ 7.5 kW have an integrated braking module. In this case, the braking resistor can be directly connected.

Easy-to-use

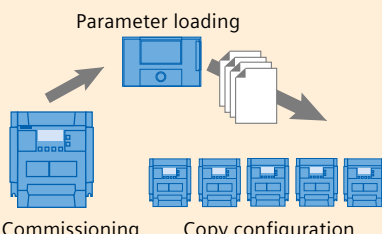
Parameter cloning		
	SINAMICS V20 feature	Your benefits
 <p>Parameter loading</p> <p>Commissioning Copy configuration</p>	<p>Parameter settings can be easily transferred from one unit to another using the BOP (Basic Operator Panel) interface – or even without power supply by using the parameter loader.</p>	<ul style="list-style-type: none"> • Less technical support required • Short commissioning time • The product is delivered to the customer already preset

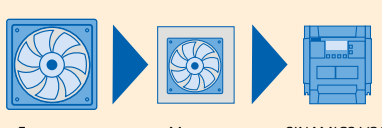
Macro approach		
	SINAMICS V20 feature	Your benefits
 <p>Fan Macro SINAMICS V20</p>	<p>Connection and application macros to simplify I/O configuration and make the appropriate settings.</p>	<ul style="list-style-type: none"> • Shorter training and commissioning time • Integrated and optimized application setting • Simple connection and application macros can be selected instead of configuring long complicated parameter lists • Errors caused by wrong parameter settings can be avoided

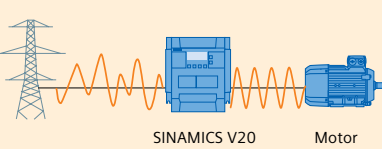
Keep Running Mode		
	SINAMICS V20 feature	Your benefits
 <p>SINAMICS V20 Motor</p>	<p>The function provides higher productivity in production by automatic adaptation in the case of unstable line supplies.</p>	<ul style="list-style-type: none"> • Stable operation under difficult line supply conditions • Higher productivity through prevention of interruptions of the production line • Adaptation to application-relevant reactions through flexible definition in case of fault/alarm

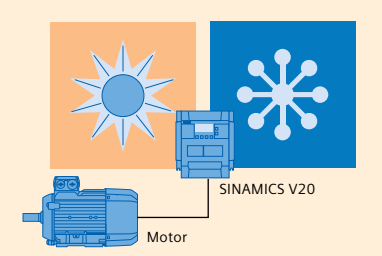
Robustness		
	SINAMICS V20 feature	Your benefits
 <p>SINAMICS V20 Motor</p>	<p>Wider voltage range, better cooling design and coated PCB increase robustness of the drive in difficult environments.</p>	<ul style="list-style-type: none"> • Operation possible when the line supply voltage fluctuates • Reliable operation for line voltages: <ul style="list-style-type: none"> – 1AC 200 V ... 240 V (–10 % / +10 %) – 3AC 380 V ... 480 V (–15 % / +10 %) • Operation up to an ambient temperature of 60 °C

Easy to save money

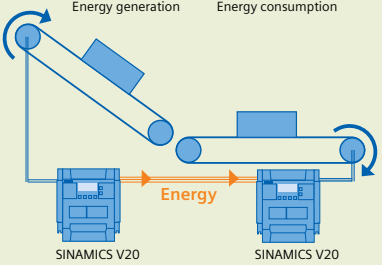

Energy reduction during operation		
	SINAMICS V20 feature	Your benefits
	<p>Integrated ECO mode for V/f and V^2/f automatically adapts the flux to save energy. The energy consumption can be shown in kWh, CO₂ or even in the local currency.</p>	<ul style="list-style-type: none"> • Energy saving during low dynamic load cycles • If the setpoint changes, the ECO mode is automatically deactivated • Tells end users the actual energy that has been saved

Energy reduction during operation — DC coupling		
	SINAMICS V20 feature	Your benefits
	<p>Applications that use SINAMICS V20 drives with the same power rating can share a common DC bus to reuse the regenerative energy.</p>	<ul style="list-style-type: none"> • Generate and save energy in applications that use coupled motors • Pairs of identical drives can optimally share resources • Reduce the need for dynamic braking and external components

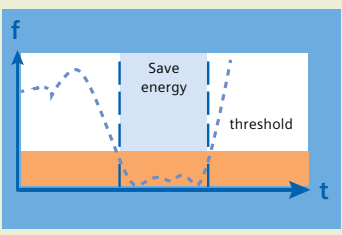
Energy reduction during standby — hibernation mode		
	SINAMICS V20 feature	Your benefits
	<p>Drive and motor only operate when the plant or machine requires them to. Hibernation mode will be activated automatically when the frequency demand or the feedback from a sensor drops below a specific threshold.</p>	<ul style="list-style-type: none"> • Smart hibernation saves energy • Extended lifetime of motor • Reduced pump wear at low speed • Less time to program PLC code for pump/fan applications (PLC)

* Application and machine-type dependent.

Easy automation system

Combining SIMATIC PLC with SINAMICS V20 drives

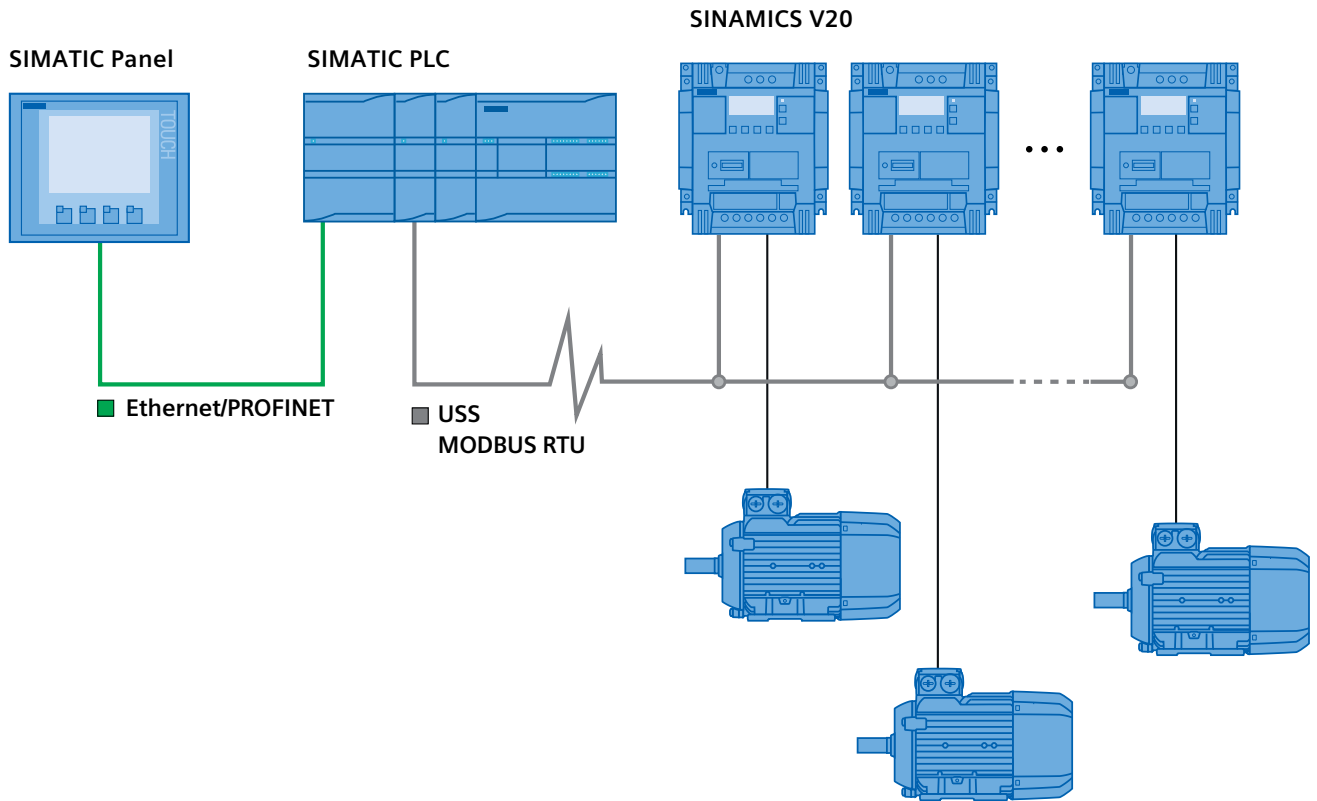

Highlights

Saving time and minimizing errors

- Easy system configuration with pre-defined macros in the drive and pre-built Totally Integrated Automation Portal function blocks for quick connection to SIMATIC S7-1200**
- One cable to connect SINAMICS V20 with USS or MODBUS RTU
- Integrated communication interface

** Application example with function blocks can be downloaded from Siemens Industry Online Support under: <http://support.automation.siemens.com/WW/view/en/63696870>



Industry services

Your machines and plants can do more

Siemens supports its customers worldwide with Services for products, systems and applications throughout the entire lifecycle of machines and plants. Customers benefit not only from our holistic service portfolio, but also from our extensive knowledge of technologies and products, as well as the industry competence of Siemens experts.

With the product-related services in particular, the focus is always on ensuring maximum plant availability in daily operation. The key here is expert consulting and support directly from the manufacturer of the drive and automation technology being used.

As a result downtimes are reduced and resource utilization is optimized. The result is greater productivity, flexibility and efficiency at a lower overall cost.

Discover all the advantages of the Industry Services portfolio at

[siemens.com/industry-services](https://www.siemens.com/industry-services)

SINAMICS V20 service

SINAMICS V20 service is integrated into our well-established global model.

- Global hotline support
- Comprehensive service network of factory-trained repair specialists
- Multiple language web-based support and FAQs

Online Support

The comprehensive online information platform supports you in all aspects of our service and support at any time and from any location in the world.

[siemens.com/automation/service&support](https://www.siemens.com/automation/service&support)

Technical support

Expert advice on technical questions with a wide range of demand-optimized services for all our products and systems.

Country	Hotline
USA	+1 423 262 5710 / +1 800 333 7421
Germany	+49 911 895 7222
India	+91 22 2760 0150
China	+86 400 810 4288

For more information about service and support, visit:
[siemens.com/automation/support-request](https://www.siemens.com/automation/support-request)

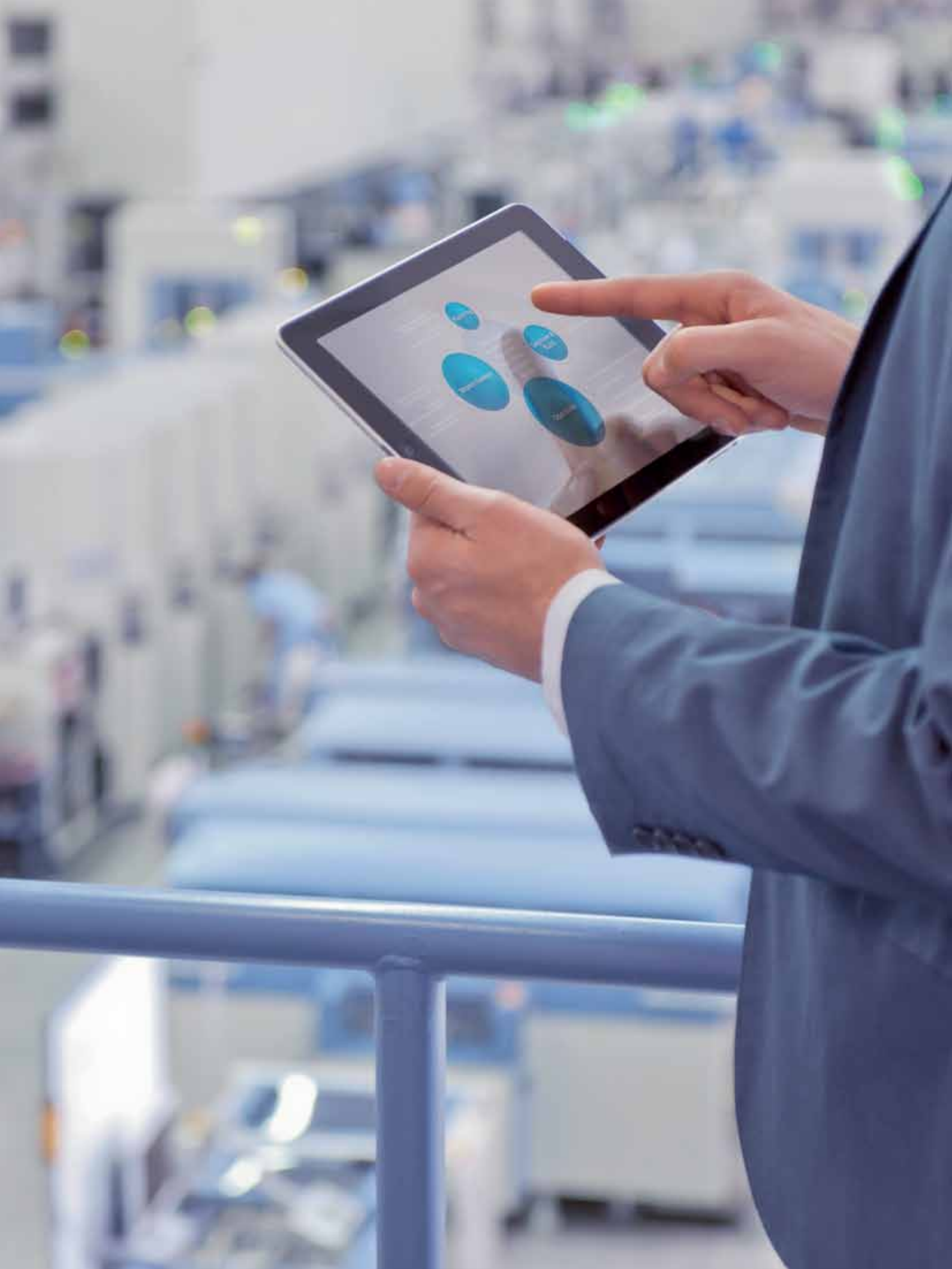

Full range of options — everything you need...

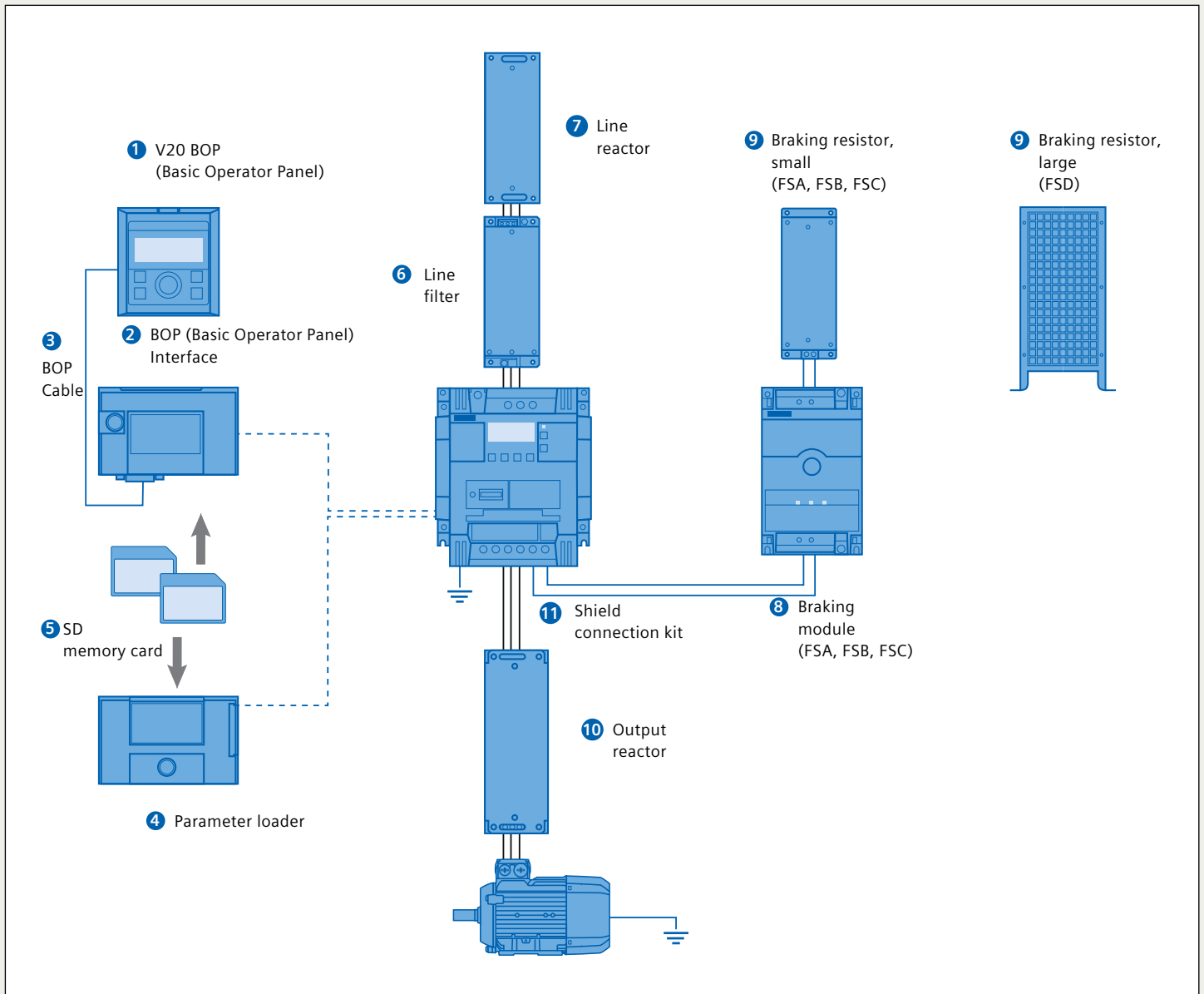

Options		
1	V20 BOP	Same function as the integrated BOP (Basic Operator Panel), but can be used for remote mounting. The value and setpoint are changed by rotating the wheel.
2	BOP interface	<ul style="list-style-type: none"> • Connection between drive and BOP • Integrated SD/MMC card slot for parameter cloning
3	BOP cable	3 m cable with connectors
4	Parameter loader	Up to 100 parameter sets with parameter settings can be written from the memory card to the drive or saved from the drive to the memory card without connecting the drive to the line supply.
5	SD memory card	SIMATIC SD memory card
6	Line filter	<ul style="list-style-type: none"> • Improved EMC performance • Longer motor cable for FSA

Options		
7	Line reactor	<ul style="list-style-type: none"> • Suppresses the harmonic current • Improves the power factor
8	Braking module	<ul style="list-style-type: none"> • Shortens the deceleration ramp time • Suitable for 1AC 230 V and 3AC 400 V • Adjustable duty cycle from 5 % to 100 % • FSD already has an integrated braking unit
9	Braking resistor	<ul style="list-style-type: none"> • Dissipates regenerative energy as heat • 5 % duty cycle as default setting
10	Output reactor	Longer motor cable: <ul style="list-style-type: none"> • 3AC 400 V shielded and unshielded cable: 150 m • 1AC 230 V shielded and unshielded cable: 200 m
11	Shield connection kit	<ul style="list-style-type: none"> • Shield connection • Strain relief

Technical data

Power and control	
Voltage	1AC 230 V: 1AC 200 V ... 240 V (-10 % ... + 10 %) 3AC 400 V: 3AC 380 V ... 480 V (-15 % ... + 10 %)
Maximum output voltage	1AC 230 V: 240 V 3AC 400 V: 480 V
Supply frequency	50/60 Hz
Line supply type	TN, TT, IT, TT earthed line
Power range	1AC 230 V 0.12 ... 3.0 kW (1/6 ... 4 hp) 3AC 400 V 0.37 ... 15.0 kW (1/2 ... 20 hp)
Power factor	0.72
Overload	150 % rated output current for 60 s, cycle time 600 s
Output frequency	0 ... 599 Hz resolution: 0.01 Hz
Efficiency factor	98 %
Control modes	Voltage/frequency control mode: linear V/f, square law V/f, multi-point V/f Flux current control mode: FCC
Standards	
Standards	CE, cULus, C-tick, KC
EMC standards	1AC 230 V with integrated line filter according to EN 61800-3 C2 3AC 400 V with integrated line filter according to EN 61800-3 C3
Features	
Energy saving	<ul style="list-style-type: none"> • ECO mode • Hibernation mode • Energy consumption monitoring
Ease of use	<ul style="list-style-type: none"> • Connection and application macro • Parameter cloning • Keep Running Mode • USS/MODBUS RTU communication • Customized default value • Automatic restart • Flying start • DC-link voltage control • I_{max} control
Application	<ul style="list-style-type: none"> • PID controller • BICO function • Hammer start • Super torque mode • Blockage clearing mode • Motor staging • Flexible boost control • Wobble function • Slip compensation • Dual ramp • Adjustable PWM modulation
Protection	<ul style="list-style-type: none"> • Frost protection • Condensation protection • Cavitation protection • Kinetic buffering • Load failure detection
Signal inputs and outputs	
Analog inputs	AI1: bipolar current / voltage mode AI2: unipolar current / voltage mode Can be used as digital inputs
Analog outputs	AO: 0 ... 20 mA
Digital inputs	DI1–DI4, optically isolated PNP/NPN selectable by terminal
Digital outputs	DO1: transistor output, DO2: relay output – 250 V AC 0.5 A with resistive load – 30 V DC 0.5 A with resistive load

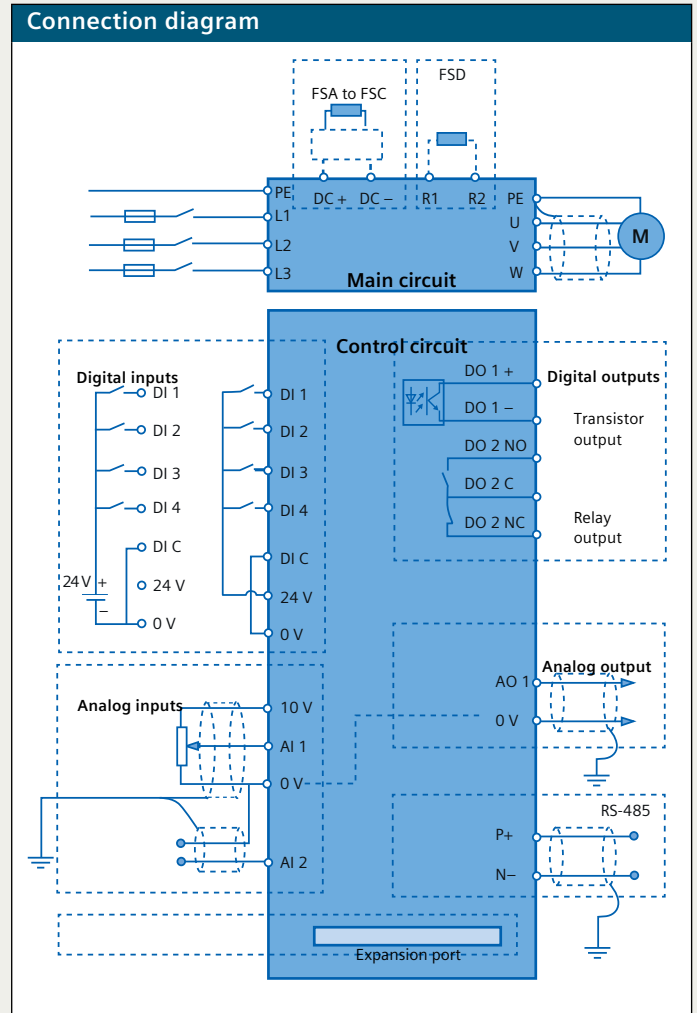

Mounting and environment	
Degree of protection	IP20
Mounting	Wall mounting, side-by-side mounting, push-through mounting for FSB, C and D
Cooling	<ul style="list-style-type: none"> • FSA up to 0.75 kW: convection cooling • FSA, FSB, FSC, FSD: power electronics cooled using heat sinks with external fan
Ambient temperature	In operation <ul style="list-style-type: none"> • 0 ... 60 °C (32 ... 140 °F) • 40 ... 60 °C (104 ... 140 °F) with derating Storage <ul style="list-style-type: none"> • -40 ... 70 °C (-40 ... 158 °F)
Relative humidity	95 % (non-condensing)
Altitude	<ul style="list-style-type: none"> • Up to 4000 m above sea level • 1000 ... 4000 m: output current derating • 2000 ... 4000 m: supply voltage derating
Motor cable length	<ul style="list-style-type: none"> • Unshielded cable: 50 m • Shielded cable: 25 m; 10 m for FSA filtered version • Longer motor cables possible with output reactor (see options)
Dynamic braking	Option module for FSA, FSB and FSC; integrated for FSD

Dimensions

SINAMICS V20

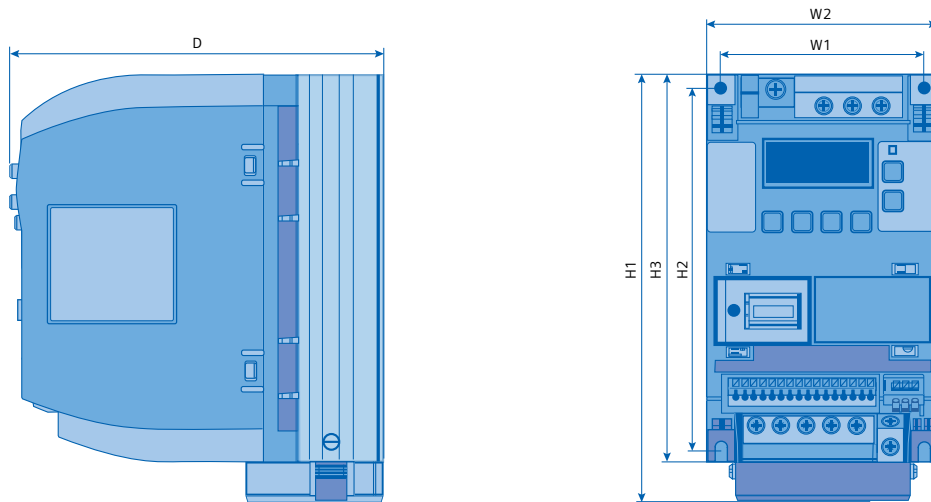

Frame size	Width (mm)		Height (mm)			Depth (mm)	Weight (kg)
	W1	W2	H1	H2	H3		
FSA without fan	79	90	–	140	150	145.5	1
FSA	79	90	166	140	150	145.5	1.05
FSB	127	140	160	135	–	164.5	1.8
FSC	170	184	182	140	–	169	2.6
FSD	223	240	206.5	166	–	172.5	4.3

1AC 230 V options

P _{rated} kW 1AC 230 V	FS	Braking resistors				Line reactors				Output reactors				Braking module				EMC filter			
		W	H	D	WT	W	H	D	WT	W	H	D	WT	W	H	D	WT	W	H	D	WT
0.12	A	230	72	43.5	1	75.5	200	50	1.4	75	200	50	1.3	90	150	80	0.71	73	200	43.5	0.5
0.25																					
0.37																					
0.55																					
0.75																					
1.1	B	239	149	43.5	1.6	150	213	50	2.2	150	213	80	4.1	90	150	80	0.71	149	213	50.5	1
1.5																					
2.2	C	285	185	150	3.8	185	245	50	5.1	185	245	80	6.6	90	150	80	0.71	–			
3																					

V20 BOP (Basic Operator Panel)

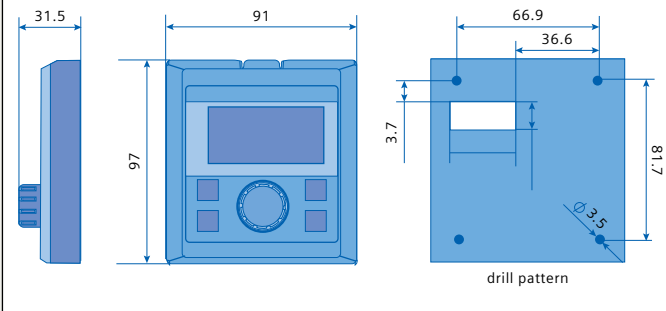

BOP (Basic Operator Panel) interface

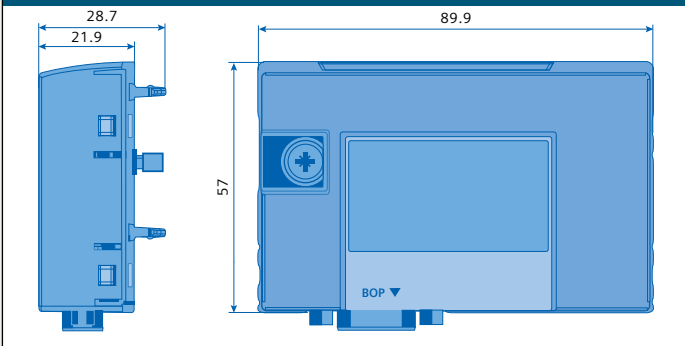

Parameter loader

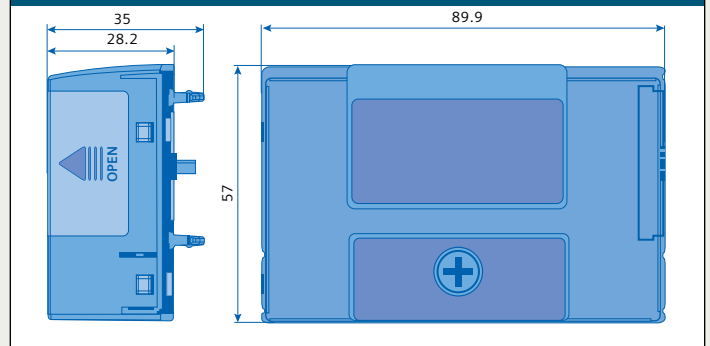

3AC 400 V options

P _{rated} kW 3AC 400 V	FS	Braking resistors				Line reactors				Output reactors				Braking module				EMC filter			
		W	H	D	WT	W	H	D	WT	W	H	D	WT	W	H	D	WT	W	H	D	WT
0.37	A	72	230	43.5	1	75.5	200	50	0.8	75.5	200	110	2	90	150	80	0.71	73	202	65	1.75
0.55																					
0.75																					
1.1																					
1.5																					
2.2	B	149	239	43.5	1.6	150	213	50	1.3	150	213	70	3.4					100	297	85	4
3																					
4	C	185	285	150	3.8	185	280	50	2.3	150	213	80	5.6					140	359	95	7.3
5.5																					
7.5																					
11	D	270	515	175	7.4																
15																					

Simple entry using the DT Configurator

The DT Configurator supports you with:

- Selecting the drive based on the application
- The subsequent ordering process

DT Configurator supplies you with

- A drive that is optimally tailored to your requirements
- 2D / 3D models
- Operating instructions
- Data sheets

You can directly order the selected components through the Industry Mall — the Siemens e-commerce website — and without having to duplicate entries. In order to avoid ordering mistakes, the order number is checked to ensure that it is correct.

siemens.com/dt-configurator



Ordering data

1AC 230 V

Rated data			Order number	Fans	Frame size
P _{rated} kW	P _{rated} hp	I _{out} A			
0.12	1/6	0.9	6SL3210-5BB11-2 V0	–	FSA
0.25	1/4	1.7	6SL3210-5BB12-5 V0	–	
0.37	1/2	2.3	6SL3210-5BB13-7 V0	–	
0.55	3/4	3.2	6SL3210-5BB15-5 V0	–	
0.75	3/4	3.9	6SL3210-5BB17-5 V0	–	
0.75	1	4.2	6SL3210-5BB18-0 V0	1	FSB
1.1	1-1/2	6	6SL3210-5BB21-1 V0	1	
1.5	2	7.8	6SL3210-5BB21-5 V0	1	FSC
2.2	3	11	6SL3210-5BB22-2 V0	1	
3	4	13.6	6SL3210-5BB23-0 V0	1	

Spare parts

Frame size	Order number
Replacement fan	
FSA	6SL3200-0UF01-0AA0
FSB	6SL3200-0UF02-0AA0
FSC	6SL3200-0UF03-0AA0
FSD	6SL3200-0UF04-0AA0

EMC Standards

With integrated line filter category C2	A
Without integrated filter	U

1AC 230 V Options

FS	P _{rated} kW 1AC 230 V	Braking resistor 6SE6400...	Line reactor 6SE6400...	Output reactor 6SE6400...	Shield connection kit 6SL3266...	EMC filter 6SE6400...
A	0.12	4BC05-0AA0	3CC00-4AB3	3TC00-4AD3	1AA00-0VA0	2FL01-0AB0
	0.25					
	0.37		3CC01-0AB3			
	0.55					
	0.75					
B	1.1	4BC11-2BA0	3CC02-6BB3	3TC01-0BD3	1AB00-0VA0	2FL02-6BB0
	1.5					
C	2.2	4BC12-5CA0	3CC03-5CB3	3TC03-2CD3	1AC00-0VA0	–
	3					

3AC 400 V

Rated data				Order number	Fans	Frame size
P _{rated} kW	P _{rated} hp	I _{out} A 400 V	I _{out} A 480 V			
0.37	1/2	1.3	1.3	6SL3210-5BE13-7	V0	–
0.55	3/4	1.7	1.6	6SL3210-5BE15-5	V0	–
0.75	1	2.2	2.2	6SL3210-5BE17-5	V0	–
1.1	1-1/2	3.1	3.1	6SL3210-5BE21-1	V0	1
1.5	2	4.1	4.1	6SL3210-5BE21-5	V0	1
2.2	3	5.6	4.8	6SL3210-5BE22-2	V0	1
3	4	7.3	–	6SL3210-5BE23-0	V0	1
4	5	8.8	8.24	6SL3210-5BE24-0	V0	1
5.5	7-1/2	12.5	11	6SL3210-5BE25-5	V0	1
7.5	10	16.5	16.5	6SL3210-5BE27-5	V0	2
11	15	25	21	6SL3210-5BE31-1	V0	2
15	20	31	31	6SL3210-5BE31-5	V0	2

EMC Standards	
With integrated line filter category C3	C
Without integrated filter	U

3AC 400 V Options

FS	P _{rated} kW 3AC 400 V	Braking resistor 6SE6400...	Line reactor 6SE6400...	Output reactor 6SE6400...	Shield connection kit 6SL3266...	EMC filter 6SL3203...
A	0.37	4BD11-0AA0	3CC00-2AD3	3TC00-4AD2	1AA00-0VA0	0BE17-7BA0
	0.55					
	0.75					
	1.1		3CC00-4AD3			
	1.5		3CC00-6AD3			
B	2.2	4BD12-0BA0	3CC01-0BD3	3TC01-0BD3	1AB00-0VA0	0BE21-8BA0
	3		3CC01-4BD3			
C	4	4BD16-5CA0	3CC02-2CD3	3TC03-2CD3	1AC00-0VA0	0BE23-8BA0
	5.5					
D	7.5	4BD21-2DA0	3CC03-5CD3	3TC05-4DD0	1AD00-0VA0	0BE23-8BA0
	11		3CC04-4DD0			
	15					

FS = frame size, WT = weight in kg, W = width in mm, H = height in mm, D = depth in mm

Name	Order number
Parameter loader	6SL3255-0VE00-0UA0
BOP (Basic Operator Panel) interface	6SL3255-0VA00-2AA0
Braking module 1AC 230 V 8 A, 3AC 400 V 7 A	6SL3201-2AD20-8VA0
V20 BOP (Basic Operator Panel)	6SL3255-0VA00-4BA0
BOP (Basic Operator Panel) cable 3 m	6SL3256-0VP00-0VA0
SIMATIC memory card (SD memory card)	6ES7954-8LB01-0AA0
RS-485 Terminator (Quantity unit 50 pcs)	6SL3255-0VC00-0HA0

Looking for more information? Look no further.

Everything you want to know about our motion control products, services and solutions can be found online:

Motion control

usa.siemens.com/motioncontrol

Motors

usa.siemens.com/simotics

Control systems

usa.siemens.com/simotion
usa.siemens.com/cnc

Drives

usa.siemens.com/drives

Energy efficiency

usa.siemens.com/energysavings

Distributor locator

usa.siemens.com/distributorlocator

Siemens Industry, Inc.
5300 Triangle Parkway, Suite 100
Norcross, GA 30092
1-770-871-3800

Order No. DRBR-V2001-0113
Printed in USA
© 2013 Siemens Industry, Inc.

The information provided in this brochure contains only general descriptions or performance features, which do not always apply in the manner described in concrete application situations or may change as the products undergo further development. Performance features are valid only if they are formally agreed upon when the contract is closed. Siemens is a registered trademark of Siemens AG. Product names mentioned may be trademarks or registered trademarks of their respective companies. Specifications are subject to change without notice.