

Fusible Disconnect switches



Fusible disconnect switches
30A – 800A, 600V



ABB PowerLine includes seven different amperage sizes from 30A to 800A. All ABB fusible switches are designed to meet customer requirements in terms of high interrupting capacity and long electrical life while occupying little more panel space than the appropriate fuses. The basic construction provides flexibility and high performance in an extremely compact size. ABB PowerLine switches are a perfect choice to withstand the heat and humidity of the tropics, the extreme cold of the arctic and any rugged industrial environment you may have.

18

International acceptance

ABB fusible switches are available with a wide range of fuse clip options:

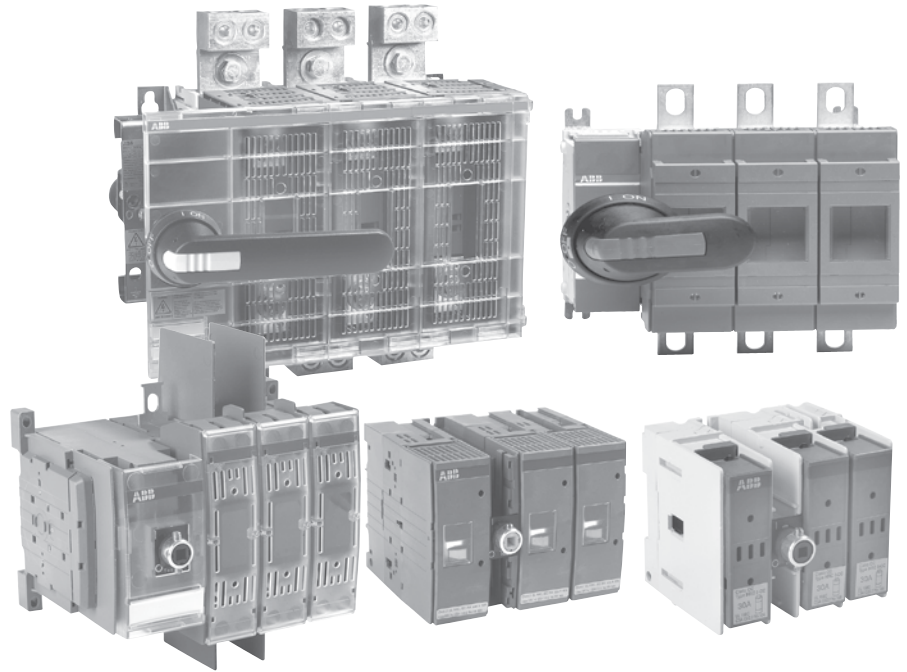
UL	USA	CSA	Canada
DIN	Europe	BS	United Kingdom
NFC	France	Ultra-rapid	

As well as the corresponding approvals: UL listed, CSA approved, IEC rated, CE marked, and most other international standards.

UL98 (CSA 22.2 No.4) – UL File # E101914, CSA File #LR58077
For 30A – 800A switches, OH_ pistol grip handles

Suitable for use as motor disconnects or industrial control panel disconnects on service entrance equipment, panelboards, switchboards, industrial control equipment, motor control centers, etc. and are horsepower rated and ampere rated.

IEC

Tested in accordance to IEC 947-1 and 3, IEC 664, IEC 269, and IEC 204

CE

Compliance with the European Machine Directive IEC 204 (EN 60204)

Selection guide OS30AFCC12 – OES800L3

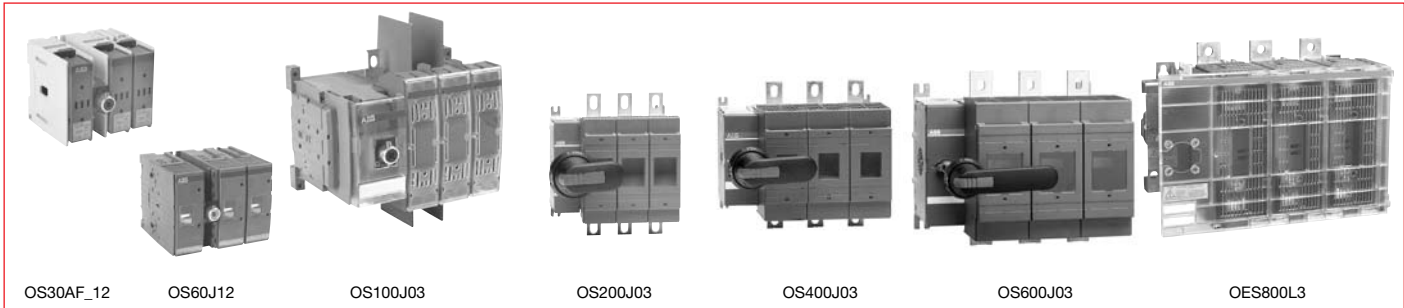

Catalog number 3 pole		OS30AFCC12	OS30AFJ12	OS60J12	OS100J03	OS200J03	OS400J03	OS600J03	OES800L3	
General purpose amp rating		A	30	30	60	100	200	400	600	800
Catalog reference		Page #	18.79	18.79	18.83	18.83	18.83	18.87	18.87	18.87
Approvals ①										
	2 pole	N/A	N/A	N/A	UL98 & IEC	UL98 & IEC	UL98 & IEC	UL98 & IEC	UL98 & IEC	UL98 & IEC
	3 pole	UL98 & IEC	UL98 & IEC	UL98 & IEC	UL98 & IEC	UL98 & IEC	UL98 & IEC	UL98 & IEC	UL98 & IEC	UL98 & IEC
	4 pole	UL98 & IEC	UL98 & IEC	UL98 & IEC	UL98 & IEC	UL98 & IEC	UL98 & IEC	UL98 & IEC	UL98 & IEC	UL98 & IEC
Technical ratings (UL, CSA)										
Max operating voltage		V	600	600	600	600	600	600	600	600
Max horsepower rating										
Three phase										
	240V	HP	7.5	7.5	15	30	60	125	200	250
	480V	HP	15	15	30	60	125	250	400	500
	600V	HP	20	20	50	75	150	350	500	600
Single phase										
	120V	HP	2	2	—	—	—	—	—	—
	240V	HP	3	3	—	—	—	—	—	—
UL fuse class			CC	J	J	J	J	J	J	L
Technical ratings (IEC)										
Rated insulation and operational voltage, AC20 and DC20		V	1000	1000	1000	1000	1000	1000	1000	1000
Rated thermal current, I _n										
	AC 20/DC 20 open	A	32	32	63	160	200	400	630	800
	AC 20/DC 20 enclosed	A	32	32	63	160	200	400	600	720
	AC 21A ≤500V	A	32	32	63	160	200	400	630	800
	≤690V	A	32	32	63	160	200	400	630	800
Rated operational power AC23										
	400/415V	kW	14/15	14/15	30	80/90	110	220/230	355	350/380
	690V	kW	25	25	60	132	200	400	560	600
Physical characteristics										
Weight										
	3 pole switch	lb	1.54	1.54	2.86	3.30	5.9	12.56	28.66	37.44
	4 pole	lb	1.98	1.98	3.52	3.96	7.5	15.21	37.48	46.26
Dimension										
	3 pole	H in	3.66	3.60	3.94	5.67	6.5	9.29	12.04	10.10
		W in	4.15	4.15	5.63	7.07	7.1	10.04	13.50	14.80
		D in	4.10	4.10	5.04	5.10	5.2	6.93	9.17	9.17
Accessories										
Double break contacts			S	S	S	S	S	S	S	S
Fuse cover			S	S	S	S	S	S	S	S
Terminal lug kit			Integral	Integral	Integral	OZXA-24	OZXA-200	OZXA-400	OZXA-800	OZXA-27
Terminal shroud			Not required	Not required	Not required	•	•	•	•	•
Auxiliary contact			•	•	•	•	•	•	•	•
Shaft/handle diameter			6mm .24 x .24"	6mm .24 x .24"	6mm .24 x .24"	6mm .24 x .24"	6mm .24 x .24"	12mm .47 x .47"	12mm .47 x .47"	12mm .47 x .47"
Handle UL/NEMA type										
	Type 1, 3R, 12		•	•	•	•	•	•	•	•
	Type 1, 3R, 4, 4X, 12		•	•	•	•	•	•	•	•
Recommended pistol handle length			45 - 65mm 290mm	45 - 65mm 290mm	45 - 65mm 290mm	45 - 65mm 290mm	65 - 80mm 290mm	125 - 175mm 595mm	125 - 175mm 595mm	125 - 175mm 595mm
Maximum recommended shaft length			—	—	—	—	—	•	•	•
Electrical interlock			—	—	—	—	—	•	•	•

① UL listed switches are also CSA approved.

Selection information

Disconnect
switches
Fusible

Standard part number designation ①

Fusible OS Switches (30 to 60A)

OS 30 F A J 22 F

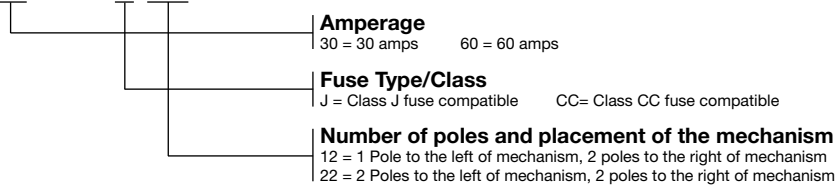

Fusible OS Switches (100A)

OS 100 J 03

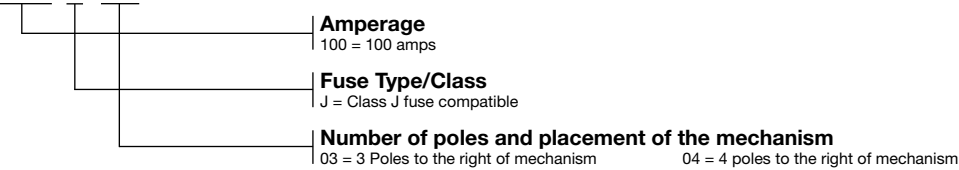

Fusible OS Switches (200A and above)

OS 200 J 04 F

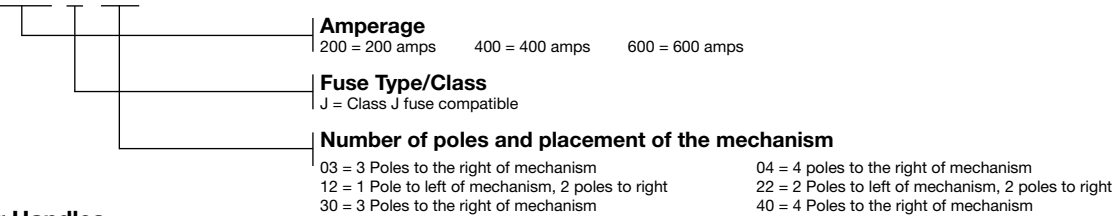

Selector Handles

OHB S 1 P H

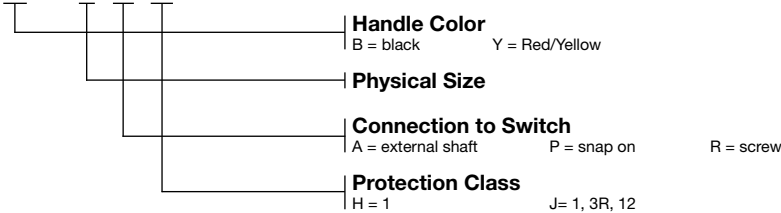

Pistol Handles

O H B 65 J 6 E011



① Part designation keys are provided for reference only. Not all variations or configurations are available.

Base & DIN rail mounted 30 – 800A

For a complete assembly, please select one of each:

- 1 switch (pg. 18.24)
- 1 handle (pg.18.25)
- 1 shaft (pg. 18.26)
- 1 terminal lug kit (pg. 18.27)

(Only required for 100A & above.)

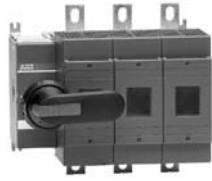

OS400J03



OXP12X280



OHB145J12



OZXA-24

	UL general purpose amp rating	UL Fuse Type 600V	2 Pole		3 Pole		4 Pole	
			Catalog number	List price	Catalog number	List price	Catalog number	List price
UL 98	30	J CC ①	—	—	OS30FAJ12 OS30FACC12	\$ 280 280	OS30FAJ22F OS30FACC22F	\$ 350 350
	60	J	—	—	OS60J12	380	OS60J22F	490
	100	J	—	—	OS100J03	520	OS100J04F	660
	200	J	OS200J02	\$ 1,240	OS200J03 OS200J30 OS200J12	1,380 1,380 1,380	OS200J04F OS200J13F OS200J22F	1,725 1,725 1,725
	400	J	OS400J02	1,680	OS400J03 OS400J30 OS400J12	1,860 1,860 1,860	OS400J04F	2,320
	600	J	OS600J02	2,600	OS600J03 OS600J30 OS600J12	4,613 4,613 4,613	OS600J04F	5,536
	800	L	OES800L2	4,280	OES800L3	4,760	OES800L4	5,950

① Rejection style fuses only.

Standard handles & shafts

Disconnect
switches
Fusible



Recommended handles & shafts

Switch	Shaft diameter	Recommended standard pistol handle length	Maximum recommended shaft length
OS30 - 100	6x6 mm - .24 x .24"	45 - 65 mm	290 mm
OS200	6x6 mm - .24 x .24"	65 - 80 mm	290 mm
OS400 - 600	12x12 mm - .47 x .47"	125 - 175 mm	595 mm
OES800	12x12 mm - .47 x .47"	125 - 175 mm	595 mm

Selector handles — for use with .24 x .24" (6mm) OXS6X shafts ② ③

UL/NEMA Type	IEC type	Color	Marking	Defeatable	Padlockable	Weight (lbs)	Catalog number	List price
1, 3R, 12	IP65	Black	O/I & Off/On	—	Yes	0.16	OHBS2AJ1	\$ 28
				Yes	Yes	0.16	OHBS2AJ	30

NOTE: Selector handles are not recommended for use with fusible switches over 30A.

Pistol handles — for use with .24 x .24" (6mm) OXP6X shafts ② ③

UL/NEMA Type	IEC type	Color	Marking	Length in/mm	Defeatable	Padlockable	Weight (lbs)	Catalog number	List price
1, 3R, 12	IP65	Black	O/I & Off/On	2.6/65	Yes	Yes	0.29	OHB65J6	\$ 80
1, 3R, 12	IP65	Black	Off/On/Test	2.6/65	Yes	Yes	0.29	OHB65J6T ①	100
1, 3R, 12	IP65	Black	O/I & Off/On	3.1/80	Yes	Yes	0.30	OHB80J6	90
1, 3R, 12, 4, 4X	IP66	Black	O/I & Off/On	3.1/80	Yes	Yes	0.30	OHB80L6	130
1, 3R, 12, 4, 4X	IP66	Stainless Steel	O/I & Off/On	3.1/65	Yes	Yes	1.60	OHM65L6	750
1, 3R, 12	IP65	Black w/ stainless hasp	O/I & Off/On	2.6/65	Yes	Yes	0.31	OHB65J6EH	250
1, 3R, 12, 4, 4X	IP66	Black w/ stainless hasp	O/I & Off/On	2.6/65	Yes	Yes	0.31	OHB65L6EH	290

Pistol handles — for use with .47 x .47" (12mm) OXP12X shafts ② ③

UL/NEMA Type	IEC type	Color	Marking	Length in/mm	Defeatable	Padlockable	Weight (lbs)	Catalog number	List price
1, 3R, 12	IP65	Black	O/I & Off/On	4.9/125	Yes	Yes	0.39	OHB125J12	\$ 90
				5.7/145	Yes	Yes	0.39	OHB145J12	90
				6.9/175	Yes	Yes	0.41	OHB175J12	100
1, 3R, 12, 4, 4X	IP66	Black	O/I & Off/On	5.7/145	Yes	Yes	0.39	OHB145L12	130
				6.9/175	Yes	Yes	0.41	OHB175L12	140
1, 3R, 12, 4, 4X	IP65	Metal	Off/On	8.7/220	--	Yes	1.50	YASDA-8	190
1, 3R, 12, 4, 4X	IP66	Stainless Steel	O/I & Off/On	4.9/125	Yes	Yes	1.70	OHM125L12	900
				6.9/175	Yes	Yes	1.80	OHM175L12	1,100
				275	Yes	Yes	2.10	OHM275L12	1,200
1, 3R, 12	IP65	Black w/ stainless hasp	O/I & Off/On	4.9/125	Yes	Yes	0.44	OHB125J12EH	280
				6.9/175	Yes	Yes	0.76	OHB175J12EH	330
1, 3R, 12, 4, 4X	IP66	Black w/ stainless hasp	O/I & Off/On	4.9/125	Yes	Yes	0.44	OHB125L12EH	330
				6.9/175	Yes	Yes	0.76	OHB175L12EH	390

Direct mount handle ② ③

For use on	Description	Marking	Color	Padlockable	Weight	Catalog number	List price
OS30	No shaft required	O/I/Test	Black	Yes	0.10	OHBS5	\$ 60
OS60-100	No shaft required	O/I	Black	Yes	0.10	OHB4	60
OS200	No shaft required	O/I	Black	Yes	0.30	OSV200BK	134
OS400	No shaft required	O/I	Black	Yes	0.30	OSV400BK	173
OS600	No shaft required	O/I	Black	Yes	0.30	OSV800BK	212
OS400-600, OES800	Mounts on 12mm shaft	—	Metal	No	0.78	YASDA-33	155

① The OS30_ switch has a TEST position, accessed by rotating the mechanism 45 degrees counterclockwise from the OFF position. In the TEST position, optional auxiliary contacts, OA4B1C, are actuated but the main switch contacts are not.

② Red/Yellow handles are available by substituting the OHB prefix with OHY.

③ All handles are plastic unless otherwise noted as metal or stainless steel.

Standard handles & shafts



Shafts — for use with OH selector handles .24 x .24" (6x6 mm)

Shaft length (in/mm)	Maximum mounting depth (inches)	Weight (Lbs.)	Catalog number	List price
5.1 / 130	5.6	0.08	OXS6X130	\$ 6
7.1 / 180	6.1	0.11	OXS6X180	6
9.8 / 250	10.3	0.13	OXS6X250	12
13 / 330	13.4	0.17	OXS6X330	20

NOTE: Selector handles and shafts are not recommended for use with fusible switches over 30A

Shafts — for use with pistol handles .24 x .24" (6x6 mm)

Shaft length (in/mm)	 Maximum mounting depth (inches)				Weight (Lbs.)	Catalog number	List price
	OS30	OS60	OS100	OS200			
5.9 / 150	8.9	9.7	9.8	—	0.09	OXP6X150	12
8.3 / 210	9.7	12.1	12.2	9.9	0.13	OXP6X210	16
11.4 / 290	13.4	15.2	15.3	13.0	0.18	OXP6X290	20
14.2 / 360	18.7	12.9	18.0	—	0.23	OXP6X360	24
16.9 / 430	22.6	20.6	20.7	—	0.27	OXP6X430	28

Shafts — for use with pistol handles .47 x .47" (12x12 mm)

Shaft length (in/mm)	 Maximum mounting depth (inches)		Weight (Lbs.)	Catalog number	List price
	OS400	OS600, OES800			
11.0 / 280	13.8	14.9	0.77	OXP12X280	\$ 36
12.8 / 325	15.6	16.7	0.9	OXP12X325	40
15.6 / 395	18.3	19.4	1.1	OXP12X395	44
18.3 / 465	21.0	22.1	1.32	OXP12X465	48
21.1 / 535	23.8	24.8	1.54	OXP12X535	52

① Mounting depth is distance from the outside of the door to the disconnect switch mounting plate. Shaft can be cut to desired length.

Standard fusible accessories Base & DIN rail mounted switches

Disconnect
switches
Fusible

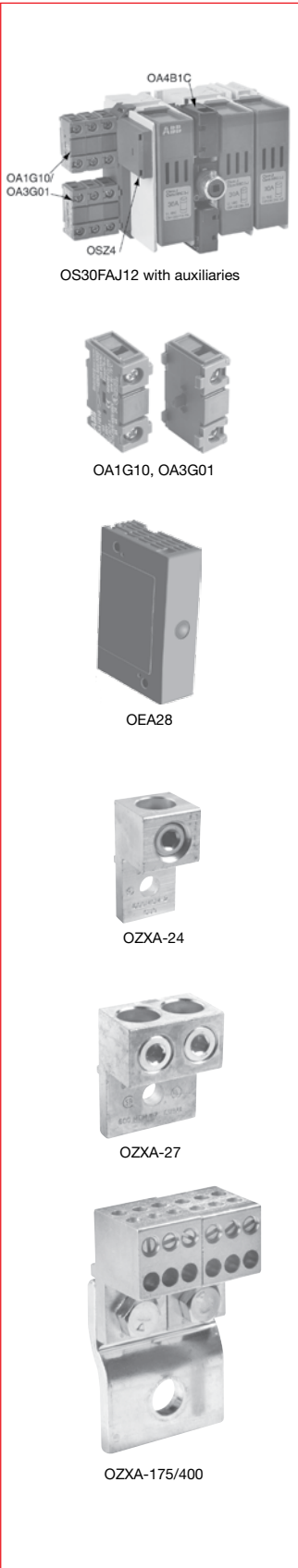

Auxiliary contacts — snap-on mounting

Description	For Use On	Weight (Lbs.)	AC Thermal amp rating	AC rated voltage	Catalog number	List price
Form C 1 N.O. & 1 N.C.	OS30	0.04	6	250	OA4B1C	\$ 40
1 N.O.	OS30 - OS600	0.07	10	600	OA1G10	20
1 N.C.	OS30 - OS600	0.07	10	600	OA3G01	20
Module for auxiliary contacts	OS30	0.09	—	—	OSZ4	20
	OS200 - OS600	0.10	—	—	OEA28	50

Auxiliary contacts — front mounting

Description	For Use On	Weight (Lbs.)	AC Thermal amp rating	AC rated voltage	Catalog number	List price
1 N.O. + 1 N.C.	OES800	0.20	10	600	OZXK-1	\$ 100
2 N.O. + 2 N.C.		0.26	10	600	OZXK-2	170
4 N.O. + 4 N.C.		0.40	10	600	OZXK-3	340
2 N.O.	OES800	0.18	10	600	OZXK-4	100
4 N.O.		0.25	10	600	OZXK-5	170
8 N.O.		0.4	10	600	OZXK-6	340

Mounting & installation considerations

OS30	Form C contacts mount directly to switch Maximum two Form C contacts OA1G10 (1 N.O.) + OA3G01 (1 N.C.) require mounting base Maximum 6 OA1G10 + OA3G01 contacts with mounting base OSZ4
OS60 - 600	Mounting to left side of switch with OEA28 module: Maximum 8 contact blocks Mounting under mechanism cover: Maximum 4 contact blocks

Terminal lugs

For Use On	Wire Size	Wire Type	Lugs/Kit	Catalog number	List price
OS100	#14 - 2/0	Cu/Al	6	OZXA-24 ①	\$ 24
OS200	#4 - 300 kcmil (6) 14-6 AWG	Cu/Al	6	OZXA-200	80
			3	OZXA-200/3	40
			3	OZXA-206/S	200
OS400	#2 - 600 kcmil (2) #2 - 300 kcmil (2) #2 - 500 kcmil	Cu/Al	6	OZXA-400	190
			6	OZXA-402	210
			6	OZXA-33	375
OS600	(2) #2 - 600 kcmil (2) - 600 kcmil	Cu/Al	6	OZXA-800	360
			3	OZXA-800/3	180
OES800	(12) #14 - 6 kcmil (2) #2 - 600 kcmil (2) #2 - 600 kcmil	Cu/Al	3	OZXA-175/400	270
			6	OZXA-27	380
			3	OZXA-27/3P	190

① Not suitable for use on cable operated flange version of OS100.

Standard fusible accessories Base & DIN rail mounted switches

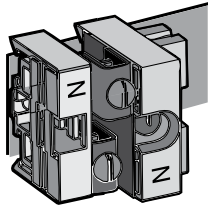

OESA-ZX171



OSS160T3

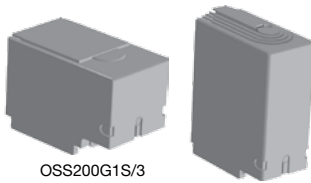

OSS200G1S/3

OSS200G1L/3

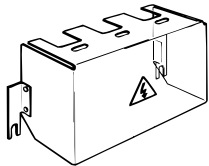

OESA-ZX70
OESA-ZX123
OESA-ZX125



OFM_



OSC60J_



CXBY68362



OESA-ZX271
OESA-ZX216

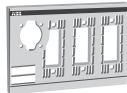

OESA-ZX272
OESA-ZX196

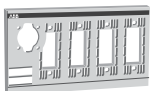

OESA-ZX273
OESA-ZX197

Additional poles

Description	For use on	Weight (Lbs.)	AC Thermal amp rating	AC rated voltage	Catalog number	List price
Detachable neutral mounts on side of switch or DIN rail	OS30	0.45	30	600	OESA-ZX171	\$ 40
	OS60	0.13	63	600	OSZ1	50
	OS100	0.31	125	600	OSZ2	50
	OES800	1.19	800	600	OESA-ZX88	160

Terminal shrouds ①

Description	For Use On	Weight (Lbs.)	Catalog number	List price
Terminal shroud for one pole	OS100	0.04	OSS160T1	\$ 20
Terminal shroud for 3 poles	OS100	0.04	OSS160T3	60
3 pole long type shrouds	OS200	0.20	OSS200G1L/3	50
3 pole short type shrouds	OS200	0.13	OSS200G1S/3	50
4 Pole long type shrouds	OS200	0.26	OSS200G1L/4	65
4 pole Short type shrouds	OS200	0.18	OSS200G1S/4	61
3 Pole includes one shroud for line or load side ②	OS400	0.13	OSS403	190
	OS600	0.11	OSS603	220
	OES800	0.11	OESA-ZX125	160

Fuse monitors

Blown fuse indicators/monitors

For Use With	Rated Voltage	Weight (lbs)	Catalog number	List price
OS30-600 and OES800	100-240	0.31	OFM240	\$ 290
	380-600	0.31	OFM600	290

Suitable for 1 or 3 phase circuits. Includes 1 N.O. and 1 N.C. auxiliary contacts and red & green LED lights for indication.

Fuse Monitor Mounting Accessories

For Use With	Crimp Terminal size (mm)	Catalog number	List price
OS30-200	2.8-0.8	OFMZX2	\$ 20
OS400-600, OES800 Includes 6 crimp terminals	6.3-0.8	OFMZX4	70

Fuse carriers/covers

Description	For Use on	Catalog number	List price
CC fuse carrier (Qty. 1)	OS30AFCC_	OESAZD48	\$ 50
J fuse carrier (Qty. 1)	OS30AFJ_	OESAZD28	50
Solid link carrier (Qty. 1)	OS30_	OESAZD55	50
Removable fuse carrier (Qty. 3)	OS60J12	OSC60J3	60
Removable fuse carrier (Qty. 4)	OS60J22F	OSC60J4	200
Transparent fuse cover	OS100	CXBY68362	20
Fuse Cover	OS200	CXBY68674	20
2 pole fuse cover	OES800	OESA-ZX216	180
3 pole fuse cover		OESA-ZX196	260
4 pole fuse cover		OESA-ZX197	350
Fuse Cover Interlock - prevents fuse cover from being opened when the switch is in the ON position	OES800	OESA-ZX204	90

① ABB switches are IP20 touchsafe as standard. Terminal shrouds provide an extra degree of protection.

② For 4 pole shrouds, please consult factory.

Standard fusible accessories

Base & DIN rail mounted switches

Disconnect
switches
Fusible



OHZX10

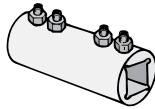

OETL-ZX95

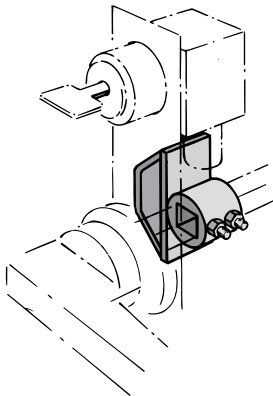

OETL-ZW16

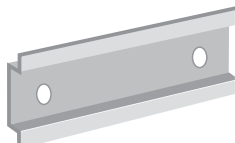

DIN rail

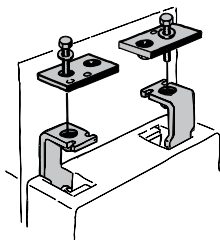

OESA-ZX1-J1T6

Miscellaneous accessories & replacement parts

Shaft accessories

Accessory Type	Description	For Use On	Weight	Catalog number	List price
Shaft Adapter	Adapts one end of a 6m shaft to 12mm (use with shaft extension coupler)	6mm shafts	0.2	OETL-ZK19	\$ 40
Shaft Extension Coupler	Joins two shafts together for applications where extended length is required	6mm shafts 12mm shafts	0.26 0.26	OESA-ZX167 OETL-ZX95	56 100
Shaft Guide	Fits all pistol grip handles, mounts on the inside of the enclosure door with provided hardware	pistol handles	-	OHZX10	12

Locking accessories

Accessory Type	Description	For Use On	Weight	Catalog number	List price
Cam Attachment	for Kirk Key, Castell, Low & Fletcher and Ronis interlock. For adapting to the interlock system. The interlock is not included.	OS60-OS200 OS400-OS600	0.25 0.29	OETL-ZW16 OETL-ZW5	\$ 190 190
Electrical Interlock	Closed circuit principle for interlocking the switch movement. When the coil circuit is dead, A-types cannot be operate to O-position and L-types cannot be operated to ON- or OFF-position. Coil voltages 110VAC, 220 VAC, 24VDC, 48VDC, 60VDC, 110VDC, 220VDC, P - 15W U = 0.7 - 1.1 Un (U = coil voltage, Un = nominal voltage)	OES800	2.42	OETL-ZT80AΔ OETL-ZT80LΔ	1280 1220

Δ = Coil Voltage

Shorting bars

Description	For Use On	AC thermal amp rating	AC rated voltage	Catalog number	List price
Dummy Fuse	OS60	60	600	OESA-ZD54	\$ 50
Solid links: metal strap	OS100	100	600	OESA-ZS36	24
	OS200	400	600	OESA-ZK98	23

T type fuse adapter kit

For Use on	For Use with	AC thermal amp rating	AC rated voltage	Poles	Catalog number	List price
OES800	300 & 600V Class T fuse	800	600	3	OESA-ZX1-L8T6	\$ 280

Replacement parts

Item	Description	For use on	Catalog number	List price
Terminal cover	Covers terminal below fuse carrier	OS30_	CXBY67121	\$ 10
Phase Barrier	-	OS200	CXBY68794	15
Shaft Set Screw	-	OS30_	FLSWM5X8AX	2

Special configurations

Shaft operated flange

30A - 100A

For a complete assembly, please select one of each.

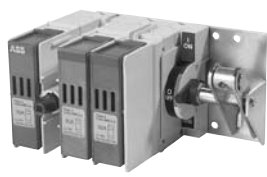

Switch



Handle



Shaft



Lug kit (as required)



OS30FAJF30



DSFHN-HS_



DSFHS_

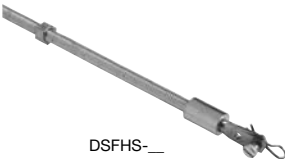

OZXA-24

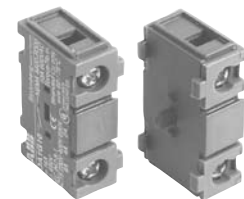

OA1G_

30A -100A Flange operated fusible switches (Shaft) – 3 pole

UL general purpose amp rating A	UL fuse type 600V	Maximum horsepower rating			Catalog number	List price
		Three phase				
		240V	480V	600V		
30	J	7.5	15	20	OS30FAJF30	\$ 500
30	CC	7.5	15	20	OS30FACCF30	500
60	J	15	30	50	OS60JF30	590
100	J	30	60	75	OS100JF30	690

Flange handles

UL/ NEMA type	Marking	Defeatable	Padlockable	Catalog number	List price
1, 3R, 12	OFF/ON	Yes	Yes	DSFHN-HS12	\$ 156
4, 4X	OFF/ON	Yes	Yes	DSFHN-HS4	240

Shafts

For use with:	Maximum enclosure depth (inches)	Catalog number	List price
OS30_ - OS100_	16	DSFHS-12	\$ 28
	21	DSFHS-17	40
	26.5	DSFHS-22	52

Terminal lug kits and accessories

For use on:	Description	Wire size	Wire type	Qty.	Catalog number	List price
OS30_	Lug	#18 - #8	Cu	--	Integral	—
OS60_	Lug	#14 - #4	Cu	--	Integral	—
OS100_	Lug	#14 - 2/0	Cu/Al	6	OZXA-24	\$ 24
OS30_ - OS100_	Aux. Contact	1 NO		1	OA1G10	20
	Aux. Contact	1 NC		1	OA3G01	20
OS30_	Adapter	Needed for mounting aux. Contacts on OS30_		1	OSZ4	20
OS100_	Shroud	Includes one set of 3 for use on line or load side		1	OSS160T3	60

Door hardware NEMA 12

Item	Catalog number	List price
Safety door latch, 2 point, door less than 40" high	KDH2R	\$ 200
Safety door latch, 3 point, door greater than 40" high	KDH3R	225

Flange operated fusible and non-fusible disconnect switches

ABB's solution for complying with the new NFPA79 requirements is Flange Operated Fusible and Non-fusible Disconnect Switches.

New 2002 NFPA 79 changes requires main disconnecting means to be operable without the use of accessory tools or devices, independent of door position. This code also includes an interlocking provision to prevent the closing of disconnects while the enclosure door is open, unless an interlock is operated by a deliberate action.

The flange operated disconnect switches are available as ridged shaft or flexible cable operated versions. The cable operated version allows you to install the disconnect switch anywhere in the enclosure depending on the length of the cable. Cables are available in lengths up to 84 inches.

The designs are cost-effective NFPA 79 solutions offering quick and easy installation.

Special configurations

Cable operated flange

30A - 200A

Disconnect
switches
Fusible

For a complete assembly, please select one each of the following:

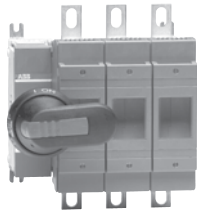

Switch



Handle



Cable



Lug kit (as required)

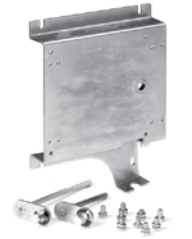

Operating mechanism

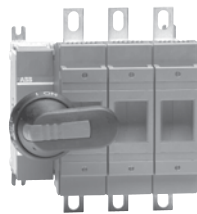

OS60J12

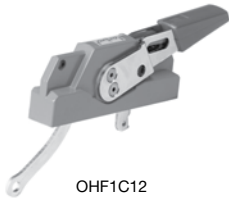

OHF1C12



OXC1L36-
OXC1L84

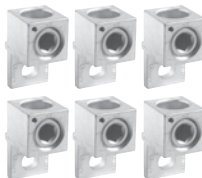

Lug Kit



OZXA-200

Fusible

UL general purpose amp rating	UL fuse type 600V	Maximum horsepower rating			Catalog number	List price
		Three phase				
		240V	480V	600V		
30	J	7.5	15	20	OS30FAJ12	\$ 280
30	CC	7.5	15	20	OS30FACC12	280
60	J	15	30	50	OS60J12	380
100	J	30	60	75	OS100AJ30	920
200	J	60	125	150	OS200J30	1,380

Flange handles — UL98; File #E101914

For use with:	Environmental rating	Catalog number	List price
OS30_12, OS60J12, OS100AJ30, OS200J30	NEMA 1, 3R, 12	OHF1C12	\$ 213
	NEMA 4, 4X	OHF1C4	243

Flexible cables

For use with:	Cable length (inches)	Catalog number	List price
OS30_12, OS60J12, OS100AJ30, OS200J30	36	OXC1L36	\$ 114
	48	OXC1L48	146
	60	OXC1L60	160
	72	OXC1L72	175
	84	OXC1L84	204

Operating mechanisms

For use with:	Catalog number	List price
OS30AFJ12, OS30AFCC12	MKCS2	\$ 135
OS60J12	MKCS3	162
OS100AJ30, OS200J30	MKCS4	171

Terminal lug kits

For use with	Wire size	Wire type	Description	Lugs per kit	Catalog number	List price
OS100AJ30 OS200J30	#4 – 300 Kcmil	Cu/Al	—	6	OZXA-200	\$ 80
	#4 – 300 Kcmil	Cu/Al	—	3	OZXA-200/3	40
	(6) #4-6 AWG	Cu/Al	Distribution lug	3	OZXA-206/S	200

Door hardware NEMA 12

Item	Catalog number	List price
Safety door latch, 2 point, door less than 40" high	KDH2R	\$ 200
Safety door latch, 3 point, door greater than 40" high	KDH3R	225

Discount schedule H3 [D3]: Fusible 30A - 100A
 Discount schedule H6 [DH]: Handles, shafts, accessories and lug kits
 Discount schedule H5 [D5]: Fusible 200A - 800A
 Discount schedule SH [SH]: Door hardware kits

Other configurations

High speed fuse pattern

Special type fuses

For a complete assembly,
please select one of each:

- 1 switch body
- 1 adapter kit
- 1 shaft
- 1 handle



Selecting switch bodies and adapter kits

Please select switch body and adapter kit according to your fuses. Switch body alone can not be used — an adapter kit is always needed.

Switch bodies — 200A through 800A

UL general purpose amp rating	Maximum horsepower rating			Max. allowed fuse power dissipation at rated current	Weight (lbs)	Catalog number	List price
	Three phase						
	240V	480V	600V				
3 pole							
200	60	125	150	22W	15.21	OES200R03	①
400	125	250	350	45W	17.20	OES400R03	
600	200	400	500	60W	37.48	OES600R03	
800	250	500	600	65W	37.48	OES800R03	
4 pole							
200	60	125	150	22W	17.4	OES200R04	①
400	125	250	350	45W	19.4	OES400R04	
600	200	400	500	60W	46.3	OES600R04	
800	250	500	600	65W	46.3	OES800R04	

Fuse adapter kits — for switches OES200 – OES400

Fuse standard	For 3 pole switch		For 4 pole switch	
	Catalog number	List price	Catalog number	List price
American standard	OESAZX1-S4 OESAZX1-S5	①	OESAZX1-S4/4 OESAZX1-S5/4	①
DIN80 (DIN43653) DIN80 sizes 00 and 000 (DIN 43653) DIN110 (DIN43653) DIN140 (DIN43653)	OESAZX1-S7 OESAZX1-S9 OESAZX1-S2 OESAZX1-S6		OESAZX1-S7/4 OESAZX1-S9/4 OESAZX1-S2/4 OESAZX1-S6/4	
Flush-end, 70mm body Flush-end, 50mm body	OESAZX1-S8 OESAZX1-S3		OESAZX1-S8/4 OESAZX1-S3/4	
French French with micro switches	OESAZX1-S10 OESAZX1-S11		OESAZX1-S10/4 OESAZX1-S11/4	

Fuse adapter kits — for switches OES600 – OES800

Fuse standard	For 3 pole switch		For 4 pole switch	
	Catalog number	List price	Catalog number	List price
American standard DIN80, DIN 110, DIN 140 (DIN43653) Flush-end, 50mm and 70mm body French French with micro switches	OESAZX2-S4 OESAZX2-S2 OESAZX2-S3 OESAZX2-S5 OESAZX2-S6	①	OESAZX2-S4/4 OESAZX2-S2/4 OESAZX2-S3/4 OESAZX2-S5/4 OESAZX2-S6/4	①

Handles and shafts — see pages 18.87 – 18.88.

Selecting the right fusible disconnect for HSF fuses may be difficult. Due to UL restrictions it is not possible to give a general fuse selection table for your use. Therefore we ask you to contact ABB Inc., Wichita Falls, in application issues. Information needed is nominal current of the application and catalog number of the fuse.

① Consult Factory.

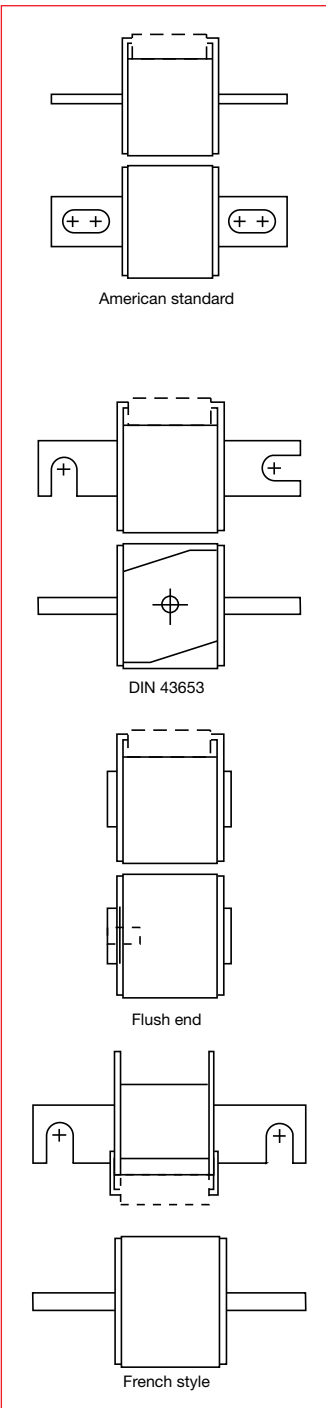

Other configurations

High speed fuse pattern

Standard switches

Disconnect
switches
Fusible

For a complete assembly, please select one switch catalog number which includes:

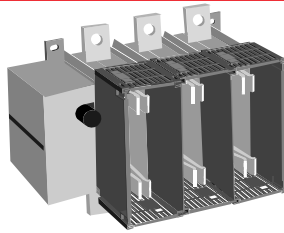

Switch body



shaft



handle

Selecting switch bodies

There are some HSF fuses that fit in standard pattern fusible disconnects, no adapter kits needed.

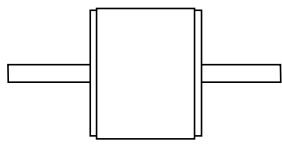
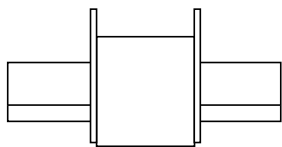

DIN 43620

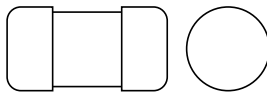

NFC Style

DIN-style fusible disconnects — 32A through 800A^①

UL general purpose amp rating	AC23A rated operational power in kW				Fuse type	Weight (lbs.)	Catalog number	List price
	230V	400V	500V	690V				
3 pole								
30	9	15	22	30	DIN 000, 00	2.9	OS32RD12	③
60	18.5	30	37	60	DIN 000, 00	2.9	OS63RD12	
100	45	80	110	132	DIN 000, 00	3.3	OS160RD03	
100	45	80	110	132	DIN 43653: 000/80	3.3	OS160RD0380	
200	70	132	170	230	DIN 0, 1	16.1	OESA250RD3	
400	110	210	280	330	DIN 0, 1, 2	18.3	OESA400RD3	
600	180	315	400	540	DIN 3	35.2	OESA630RD3	
800	200	350	470	600	DIN 3	39.6	OESA800RD3	
4 pole								
30	9	15	22	30	DIN 000, 00	3.5	OS32RD22	③
60	18.5	30	37	60	DIN 000, 00	3.5	OS63RD22	
100	45	80	110	132	DIN 000, 00	4.0	OS160RD04	
100	45	80	110	132	DIN 43653: 000/80	4.0	OS160RD0480	
200	70	132	170	230	DIN 0, 1	18.1	OESA250RD4	
400	110	210	280	330	DIN 0, 1, 2	20.7	OESA400RD4	
600	180	315	400	540	DIN 3	46.3	OESA630RD4	
800	200	350	470	600	DIN 3	52.9	OESA800RD4	

NFC-style fusible disconnects — 25A through 125A^②

UL general purpose amp rating	AC23A rated operational power in kW				Fuse type	Weight (lbs.)	Catalog number	List price
	230V	400V	500V	690V				
3 pole								
30	6	11	14	22	NFC 10x38	1.54	OS25FRF1210	③
30	8	14	18	25	NFC 14x51	1.54	OS32RF1214	
60	18.5	30	37	60	NFC 14x51	2.90	OS63RF1214	
100	37	60	80	110	NFC 22x58	3.30	OS125RF0322	
100	45	80	110	132	NFC 27x60	3.30	OS160RF0327	
4 pole								
30	6	11	14	22	NFC 10x38	2.00	OS25FRF2210	③
30	8	14	18	25	NFC 14x51	2.00	OS32RF2214	
60	18.5	30	37	60	NFC 14x51	3.50	OS63RF2214	
100	37	60	80	110	NFC 22x58	4.00	OS125RF0422	
100	45	80	110	132	NFC 27x60	4.00	OS160RF0427	

Selecting the right fusible disconnect for HSF fuses may be difficult. Due to UL restrictions it is not possible to give a general fuse selection table for your use. Therefore we ask you to contact ABB Control Inc., Wichita Falls, regarding application issues.

① OS32 – OS160 include handle OHB65J6 and shaft OXP6X161.
OESA250 – OESA400 include handle OHB125J12 and shaft OXP12X250.
OESA630 – OESA800 include handle OHB145J12 and shaft OXP12X250.

② OS25 – OS125 include handle OHB65J6 and shaft OXP6X161.

③ Consult factory.

Discount schedule H4 [D4]: Fusible, 30A – 100A

Discount schedule H5 [D5]: Fusible, 200A – 800A

Discount schedule H6 [DH]: Handles, shafts, accessories & lug kits

Other configurations

BS fuse pattern ① 20A – 800A

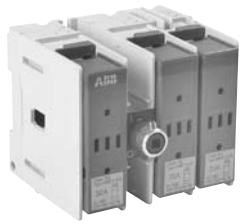

OS32B12A1



OS63B12

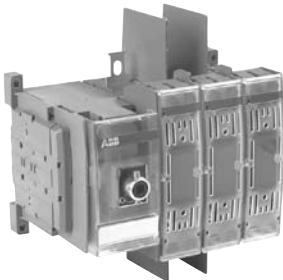

OS160

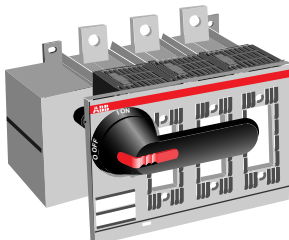

OS200B3

BS fuse pattern switches (20A – 32A)

Handle and shaft included

Catalog number	number of poles	Rated op. current/ Rated op. power		Fuse type and size	Fuse standard
		415V	690V		
OS20FB12A1 OS20FB22A1N1 OS20FB22A1F	3 3 + non-fused neutral 4	20 A 10 kW	20A 15 kW	A1 20 A	BS 88-2 IEC 269-2-1
OS32B12A1 OS32B22A1N1 OS32B22A1F	3 3 + non-fused neutral 4	32 A 15 kW	32A 25 kW	A1 32 A	
OS32B12A2 OS32B22A2N1	3 3 + non-fused neutral	32 A 15 kW	32A 25 kW	A2 32 A	
OS32B12F1 OS32B22F1N1	3 3 + non-fused neutral	32 A 15 kW	32A 25 kW	F1 32 A	BS 88-6

BS pattern switches (32A – 800A)

Handle and shaft included

Fuse covers included for 200A – 800A

Catalog number	number of poles	Rated operational voltage AC23/[V]	I _{th} (open) [A]	Rated operational current/ Rated operational power in category AC23A, IEC947 [A/kW]					Weight with package [kg]
				230V	400V	415V	500V	690V	
OS32B12 OS32B22N1	3 4 ^②	500	32	32/7.5	32/11	32/15	32/15	—	1.3 1.6
OS63B12 OS63B22N1	3 4 ^②	690	63	63/15	63/30	63/30	63/30	401/30	1.3 1.6
OS100B12 OS100B13 OS100B01 OS100B11	3 4 ^② 1 2	690	125	100/30	100/55	100/55	100/70	501/45	1.5 1.8 0.9 1.9
OS160B12 OS160B13 OS160B01 OS160B11	3 4 1 2	690	160	100/30	100/55	100/55	100/70	50 [⊖] /45	1.5 1.8 0.9 1.2
OS200B3 OS200B4 OS200B1 OS200B2	3 4 ^② 1 2	690	200	200/57	200/100	200/110	200/140	200/180	7.1 8.2 5.1 6.1
OS250B3 OS250B4	3 4 ^②	690	250	250/70	250/132	250/140	250/170	250/230	7.1 8.2
OS315B3 OS315B4 OS315B1 OS315B2	3 4 ^② 1 2	690	315	315/90	315/100	315/100	315/220	315/290	7.9 8.9 5.9 6.9
OS400B3 OS400B4 OS400B1 OS400B2	3 4 ^② 1 2	690	400	400/110	400/210	400/230	400/280	400/330	8.3 9.4 6.3 7.3
OS630B3 OS630B4 OS630B1 OS630B2	3 4 ^② 1 2	690	630	630/180	630/315	630/340	630/400	630/540	16.0 21.0 6.5 11.0
OS800B3 OS800B4 OS800B1 OS800B2	3 4 ^② 1 2	690	800	800/200	800/350	800/380	720/470	720/600	18.0 24.0 6.7 12.3



BS fuses are widely used in UK, South-Africa, Australia and Hong Kong

① Please consult factory for additional information.

② The fourth pole is provided with a solid link which can be replaced with a fuse.

Other configurations

DIN fuse pattern ①

32A – 800A

Disconnect
switches
Fusible



OS63D12

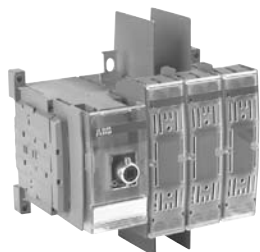

OS160

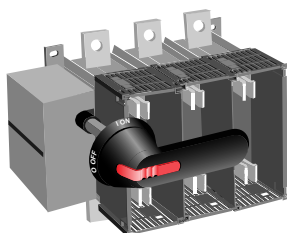

OS250P3P

DIN pattern switches (32A – 800A)

Handle and shaft included

Catalog number	Number of poles	Operational AC23[V]	I _{th} (open) [A]	Rated operational current/ Rated operational power in category AC23A, IEC947 [A/kW]					Weight with package [kg]
				230V	400V	415V	550V	690V	
OS32D12 OS32D22N1 OS32D22F	3 3 + non-fused neutral 4	690	32	32/7.5	32/11	32/15	32/15	–	1.3 1.6 1.6
OS63D12 OS63D22N1 OS63D22F	3 3 + non-fused neutral 4	690	63	63/15	63/30	63/30	63/30	40/30	1.3 1.6 1.6
OS125D12 OS125D22N1 OS125D22F OS125D01 OS125D11	3 3 + non-fused neutral 4 1 2	690	125	100/30	100/55	100/55	100/70	50/45	1.5 1.8 1.8 0.9 1.2
OS160D12 OS160D22N1 OS160D22F OS160D01 OS160D11	3 3 + non-fused neutral 4 1 2	690	160	100/30	100/55	100/55	100/70	50/45	1.5 1.8 1.8 0.9 1.2
OS250D3P OS250D4P OS250DF4P OS250D1P OS250D2P	3 3 + non-fused neutral 4 1 2	690	250	250/70	250/132	250/140	250/170	250/230	7.3 8.2 8.2 5.5 6.4
OS400D3P OS400D4P OS400DF4P OS400D1P OS400D2P	3 3 + non-fused neutral 4 1 2	690	400	400/110	400/210	400/230	400/280	400/330	8.3 9.4 9.4 6.3 7.3
OS630D3P OS630D4P OS630DF4P OS630D1P OS630D2P	3 3 + non-fused neutral 4 1 2	690	630	630/180	630/315	630/340	630/400	630/540	16.0 21.0 21.0 6.5 11.0
OS800D3P OS800D4P OS800DF4P OS800D1P OS800D2P	3 3 + non-fused neutral 4 1 2	690	800	800/200	800/350	800/380	720/470	720/600	18.0 24.0 24.0 8.5 13.0



DIN fuses are mainly used in continental Europe (excluding France below 125A), Asia, Africa and South-America

① Please consult factory for additional information.

Other configurations

NFC fuse pattern

63A – 125A, 14x51 & 22x58



OS32FF1214



OS63F12

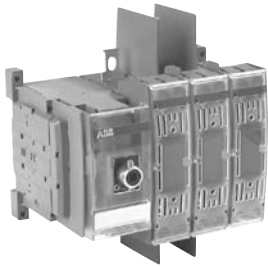

OS125F03

NFC fuse pattern switches (cylinder) (10x38) (14x51)

Handle and shaft included

Catalog number	number of poles	Rated operational current/ Rated operational power		Fuse type and size	Fuse standard
		415V	690V		
OS25FF1210 OS25FF2210N1 OS25FF2210F	3 3 + non-fused neutral 4	25 A 12 kW	25A 22 kW	10 x 38 25 A	IEC 269-2-1
OS32FF1214 OS32FF2214N1 OS32FF2214F	3 3 + non-fused neutral 4	32 A 15 kW	32A 25 kW	14 x 51 32 A	IEC 269-2-1

NFC fuse pattern (cylinder fuse links), (14x51 & 22x58)

Handle and shaft included

Catalog number	number of poles	Rated operational voltage AC23[V]	I _{th} (open) [A]	Rated operational power in category AC23A, IEC947 [A/kW]					Weight with pack- age [kg]
				230V	400V	415V	550V	690V	
OS50F12 OS50F22F	3 4	690	50	50/15	50/25	50/25	50/33	50/45	1.3 1.6
OS63F12 OS63F22F	3 4	690	63	63/18.5	63/30	63/30	63/37	63/60	1.3 1.6
OS100F03 OS100F04F OS100F04N1	3 4 3 + non-fuse N	690	125	100/30	100/45	100/55	100/60	100/90	2.2 2.8 2.8
OS125F03 OS125F04F OS125F04N1	3 4 3 + non-fuse N	690	125	125/37	125/60	125/60	125/80	125/110	1.3 1.6 1.6



NFC fuses are used in France and in French speaking Africa

① Please consult factory for additional information.

Coming soon OS800

Disconnect
switches
Fusible

OS800

UL general purpose amp rating	UL Fuse type 600 V	2 Pole	3 Pole	4 Pole
		Catalog number	Catalog number	Catalog number
800	L	OS800L02	OS800L03 OS800L30 OS800L12	OS800L04F
1200	L	OS1200L02	OS1200L03	OS1200L04F

T-Style handles — for use with .47 x .47" (12x12mm) shafts ①

UL/NEMA Type	IEC Type	Color	Marking	Length	Defeatable	Padlockable	Catalog number
1, 3R, 12	IP65	Black	O/I & Off/On	2 x 200	Yes	Yes	OHB200J12P

Shafts for use with T-Style handles — .47 x .47" (12x12mm)

Shaft length	Maximum mounting depth	Weight (Lbs.)	Catalog number
11.0 / 280	15.2	0.77	OX P12X280
12.8 / 325	17.0	0.90	OX P12X325
15.6 / 395	19.7	1.10	OX P12X395
18.3 / 465	22.4	1.32	OX P12X465
21.1 / 535	25.2	1.54	OX P12X535

Terminal lugs

For use on	Wire size	Wire type	Lugs per kit	Catalog number
OS1200	(4) #2-600 kcmil	Cu/Al	6	OZXA-1200
OS800	(2) #2 - 600 kcmil	Cu/Al	6	OZXA-800
	(2) - 600 kcmil	Cu/Al	3	OZXA-800/3

Auxiliary contacts

Description	For use on	AC thermal amp rating	AC rated voltage	Catalog number
1 NO	OS800 - 1200	10	600	OA1G10
1 NC				OA3G01
Module for contacts				OEA28