

LENOX®













HOLE SAWS



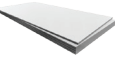

HOLE SAW SELECTION GUIDE

	WOOD	NAIL-EMBEDDED WOOD	NON-FERROUS METAL	PLASTICS & COMPOSITES	METAL	STAINLESS STEEL	DRYWALL / PLASTER	CAST IRON	CEMENT BOARD	ABRASIVES	TILE & GRANITE	
												
BEST	CARBIDE TIPPED		CARBIDE GRIT	CARBIDE TIPPED			LENOX® <i>DIAMOND</i> ™					
BETTER	BI-METAL		BI-METAL				CARBIDE TIPPED	CARBIDE GRIT				
GOOD	CARBIDE GRIT	—	CARBIDE GRIT	CARBIDE TIPPED	CARBIDE GRIT			CARBIDE GRIT	BI-METAL	—	CARBIDE TIPPED	

NEW

SPEED SLOT® HOLE SAWS WITH T3 TECHNOLOGY™

50% Longer Life. 2X More Durable.*

IMPROVED METAL CUTTING PERFORMANCE

Increased wall thickness improves durability and minimizes tooth loss
Optimized tooth design penetrates metal with ease

FAST, EFFICIENT CUTTING IN WOOD

Larger, sharper teeth remove more wood for fast cutting

EASY PLUG REMOVAL

SPEED SLOT staircase design for fast, easy plug ejection

*vs. Prior LENOX Generation



SPEED SLOT® staircase for fast, easy plug removal

Advanced tooth design increases cutting life



10% Thicker Wall adds strength and durability





BI-METAL SPEED SLOT® HOLE SAW WITH T3 TECHNOLOGY™



DIAMETER		1 PER BOX	1 PER BLISTER SEAL	1 PACK ARBORED	PIPE TAP		PIPE ENTRANCE		USE ARBOR	
IN	MM	PROD NO	PROD NO	PROD NO	IN	MM	IN	MM	SNAP-BACK™	STANDARD
9/16	14.3	300099L	1787781	1772423	—	—	—	—	5L	1L, 4L or 5L
5/8	15.9	3001010L	1771823	1772424	—	—	—	—	5L	1L, 4L or 5L
11/16	17.5	3001111L	1787773	1772425	—	—	—	—	5L	1L, 4L or 5L
3/4	19.1	3001212L	1771952	1772426	1/2	12.7	3/8	9.5	5L	1L, 4L or 5L
25/32	19.8	3009820MMHS	1771962	1772427	—	—	—	—	5L	1L, 4L or 5L
13/16	20.6	3001313L	1787775	1772428	—	—	—	—	5L	1L, 4L or 5L
7/8	22.2	3001414L	1771953	1772429	3/4	19.1	1/2	12.7	5L	1L, 4L or 5L
15/16	23.8	3001515L	1787776	1772430	—	—	—	—	5L	1L, 4L or 5L
1	25.4	3001616L	1771954	1772481	—	—	—	—	5L	1L, 4L or 5L
1-1/16	27.0	3001717L	1771955	1772482	—	—	—	—	5L	1L, 4L or 5L
1-1/8	28.6	3001818L	1771959	1772483	1	25.4	3/4	19.1	5L	1L, 4L or 5L
1-3/16	30.2	3001919L	1787777	1772474	—	—	—	—	5L	1L, 4L or 5L
1-1/4	31.8	3002020L	1771960	1772491	—	—	—	—	2L, 6L	2L, 3L or 6L
1-5/16	33.3	3002121L	1787778	1772492	—	—	—	—	2L, 6L	2L, 3L or 6L
1-3/8	34.9	3002222L	1771961	1772727	—	—	1	25.4	2L, 6L	2L, 3L or 6L
1-7/16	36.5	3002323L	1787779	1772728	—	—	—	—	2L, 6L	2L, 3L or 6L
1-1/2	38.1	3002424L	1771963	1772729	1-1/4	31.8	—	—	2L, 6L	2L, 3L, 6L or 7L
1-9/16	39.7	3002525L	1787780	1772730	—	—	—	—	2L, 6L	2L, 3L, 6L or 7L
1-5/8	41.3	3002626L	1771964	1772931	—	—	—	—	2L, 6L	2L, 3L, 6L or 7L
1-11/16	42.9	3002727L	1787800	1772932	—	—	—	—	2L, 6L	2L, 3L, 6L or 7L
1-3/4	44.5	3002828L	1771967	1772933	1-1/2	38.1	1-1/4	31.8	2L, 6L	2L, 3L, 6L or 7L
1-13/16	46.0	3002929L	1787841	1772935	—	—	—	—	2L, 6L	2L, 3L, 6L or 7L
1-7/8	47.6	3003030L	1771968	1772778	—	—	—	—	2L, 6L	2L, 3L, 6L or 7L
2	50.8	3003232L	1771970	1772779	—	—	1-1/2	38.1	2L, 6L	2L, 3L, 6L or 7L
2-1/16	52.4	3003333L	1787842	1772780	—	—	—	—	2L, 6L	2L, 3L, 6L or 7L
2-1/8	54.0	3003434L	1772003	1772951	—	—	—	—	2L, 6L	2L, 3L, 6L or 7L
2-1/4	57.2	3003636L	1771983	1772952	2	50.8	—	—	2L, 6L	2L, 3L, 6L or 7L
2-3/8	60.3	3003838L	1771984	1772953	—	—	—	—	2L, 6L	2L, 3L, 6L or 7L
2-1/2	63.5	3004040L	1771987	1772954	—	—	2	50.8	2L, 6L	2L, 3L, 6L or 7L
2-9/16	65.1	3004141L	1787843	1772955	—	—	—	—	2L, 6L	2L, 3L, 6L or 7L
2-5/8	66.7	3004242L	1771988	1772956	2-1/2	63.5	—	—	2L, 6L	2L, 3L, 6L or 7L
2-11/16	68.3	3004343L	1771989	—	—	—	—	—	2L, 6L	2L, 3L, 6L or 7L
2-3/4	69.9	3004444L	1771990	1772961	—	—	—	—	2L, 6L	2L, 3L, 6L or 7L
2-7/8	73.0	3004646L	1787844	1772962	—	—	—	—	2L, 6L	2L, 3L, 6L or 7L
3	76.2	3004848L	1772021	1772963	—	—	2-1/2	63.5	2L, 6L	2L, 3L, 6L or 7L
3-1/8	79.4	3005050L	1772022	1772964	—	—	—	—	2L, 6L	2L, 3L, 6L or 7L
3-1/4	82.6	3005252L	1772023	1772966	3	76.2	—	—	2L, 6L	2L, 3L, 6L or 7L
3-3/8	85.7	3005454L	1787845	1772945	—	—	—	—	2L, 6L	2L, 3L, 6L or 7L
3-1/2	88.9	3005656L	1772012	1772946	—	—	—	—	2L, 6L	2L, 3L, 6L or 7L
3-5/8	92.1	3005858L	1772013	1772949	—	—	3	76.2	2L, 6L	2L, 3L, 6L or 7L
3-3/4	95.3	3006060L	1787846	1772950	3-1/2	85.7	—	—	2L, 6L	2L, 3L, 6L or 7L
3-7/8	98.4	3006262L	1787847	1773001	—	—	—	—	2L, 6L	2L, 3L, 6L or 7L
4	101.6	3006464L	1772014	1773002	—	—	—	—	2L, 6L	2L, 3L, 6L or 7L
4-1/8	104.8	3006666L	1772018	1773003	—	—	3-1/2	85.7	2L, 6L	2L, 3L, 6L or 7L
4-1/4	108.0	3006868L	1772019	1773004	4	95.3	—	—	2L, 6L	2L, 3L, 6L or 7L
4-3/8	111.1	3007070L	1787848	1773005	—	—	—	—	2L, 6L	2L, 3L, 6L or 7L
4-1/2	114.3	3007272L	1772075	1773006	—	—	—	—	2L, 6L	2L, 3L, 6L or 7L
4-5/8	117.5	3007474L	1787850	—	—	—	4	95.3	2L, 6L	2L, 3L, 6L or 7L
4-3/4	120.7	3007676L	1772076	1773008	4-1/2	108.0	—	—	2L, 6L	2L, 3L, 6L or 7L
5	127.0	3008080L	1772077	—	—	—	—	—	2L, 6L	2L, 3L, 6L or 7L
5-1/2	139.7	3008888L	1787785	—	—	—	—	—	2L, 6L	2L, 3L, 6L or 7L
6	152.4	3009696L	1772121	—	—	—	—	—	2L, 6L	2L, 3L, 6L or 7L

RECOMMENDED HOLE SAW RPM

BI-METAL

DIAMETER		MILD STEEL	TOOL / STAINLESS STEEL	CAST IRON	BRASS	ALUM
IN	MM					
9/16	14.3	580	300	400	790	900
5/8	15.9	550	275	365	730	825
11/16	17.5	500	250	330	665	750
3/4	19.1	460	230	300	600	690
25/32	19.8	425	210	280	560	630
13/16	20.6	425	210	280	560	630
7/8	22.2	390	195	260	520	585
15/16	23.8	370	185	245	495	555
1	25.4	350	175	235	470	525
1-1/16	27.0	325	160	215	435	480
1-1/8	28.6	300	150	200	400	450
1-3/16	30.2	285	145	190	380	425
1-1/4	31.8	275	140	180	360	410
1-5/16	33.3	260	135	175	345	390
1-3/8	34.9	250	125	165	330	375
1-7/16	36.5	240	120	160	315	360
1-1/2	38.1	230	115	150	300	345
1-9/16	39.7	220	110	145	290	330
1-5/8	41.3	210	105	140	280	315
1-11/16	42.9	205	100	135	270	305
1-3/4	44.5	195	95	130	250	295
1-13/16	46.0	190	95	125	250	285
1-7/8	47.6	180	90	120	240	270
2	50.8	170	85	115	230	255
2-1/16	52.4	165	80	110	220	245
2-1/8	54.0	160	80	105	210	240
2-1/4	57.2	150	75	100	200	225
2-3/8	60.3	140	70	95	190	220
2-1/2	63.5	135	65	90	180	205
2-9/16	65.1	130	65	85	175	200
2-5/8	66.7	130	65	85	170	195
2-11/16	68.3	125	60	80	160	185
2-3/4	69.9	125	60	80	160	185
2-7/8	73.0	120	60	80	160	180
3	76.2	115	55	75	150	170
3-1/8	79.4	110	55	70	140	165
3-1/4	82.6	105	50	70	140	155
3-3/8	85.7	100	50	65	130	150
3-1/2	88.9	95	45	65	130	145
3-5/8	92.1	95	45	60	120	140
3-3/4	95.3	90	45	60	120	135
3-7/8	98.4	85	40	55	110	130
4	101.6	85	40	55	110	130
4-1/8	104.8	80	40	55	110	120
4-1/4	108.0	80	40	55	110	120
4-3/8	111.1	75	35	50	100	105
4-1/2	114.3	75	35	50	100	105
4-5/8	117.5	75	35	50	100	105
4-3/4	120.7	70	35	45	90	95
5	127.0	70	35	45	90	95
5-1/2	139.7	65	30	40	85	90
6	152.4	65	30	40	85	90





BI-METAL SPEED SLOT® HOLE SAW WITH T3 TECHNOLOGY™ KITS

Convenient Storage for Trade-Specific Uses

DURABLE

Durable construction resists damage caused by drops and tough workplace environments

SECURE

Latches close case tightly and securely

LONG LASTING

Metal latches and metal pin hinges won't break or tear



LARGE KIT
10"h x 14"w

MEDIUM KIT
8"h x 11"w

COMPACT KIT
4-11/16"h x 7-1/2"w

MINI KIT
9"h x 5"w



CONTRACTOR'S HOLE SAW 5 PACKS

VALUE & CONVENIENCE

Unique packaging provides value and convenience for high volume users



PROD NO	IN	MM	PROD NO	IN	MM
10735B14L	7/8	22.2	10739B22L	1-3/8	34.9
10736B16L	1	25.4	10740B24L	1-1/2	38.1
10737B18L	1-1/8	28.6	10741B28L	1-3/4	44.5
10738B20L	1-1/4	31.8	10742B32L	2	50.8

ARBORED KITS



34082600AP
6 PIECE KIT
PLUMBER'S KIT

3/4", 7/8", 1-1/8",
1-1/2", 1-3/4", 2-1/4"

LARGE KIT



34081600AE
6 PIECE KIT
ELECTRICIAN'S KIT

7/8", 1-1/8", 1-3/8",
1-3/4", 2", 2-1/2"

LARGE KIT

CONTRACTOR'S KITS



30370400G
5 PIECE KIT

2", 3", 3-3/8",
4-1/8"
Standard
Arbor: 2L

LARGE KIT



308042000G
26 PIECE KIT-BIG DADDY™

3/4", 7/8", 1", 1-1/8", 1-3/8", 1-1/2",
1-3/4", 2", 2-1/8", 2-1/4", 2-1/2",
2-11/16", 3", 3-1/4", 3-3/8", 3-5/8",
3-3/4", 4-1/8", 4-1/2", 4-3/4"
Standard Arbors: 1L, 2L, 5L

Three pilot drills

LARGE KIT



30807700G
9 PIECE KIT

7/8", 1", 1-1/4",
1-3/8", 1-1/2",
1-3/4", 2-1/8"
Standard
Arbors: 5L, 6L

MEDIUM KIT



30374500G
9 PIECE KIT

2-1/8", 2-9/16",
3-1/4",
3-3/4", 4-3/4"
Standard
Arbor: 2L

Three pilot drills
LARGE KIT



308201200G
17 PIECE KIT

5/8", 3/4", 7/8", 1", 1-1/8",
1-1/4", 1-3/8", 1-1/2",
1-3/4", 2", 2-1/2", 3"
Standard Arbors: 1L, 2L

Three pilot drills

LARGE KIT



1815140
7 PIECE KIT

7/8", 1", 1-1/8",
1-1/2", 2-1/8"
Standard Arbors:
2L, 5L

MINI KIT

ELECTRICIAN'S KITS



30856C600L
9 PIECE KIT
 7/8", 1-1/8", 1-3/8", 1-3/4", 2", 2-1/2"
 Standard Arbors: 2L, 5L
 One Arbor adaptor
MEDIUM KIT



30800600L
10 PIECE KIT
 7/8", 1-1/8", 1-3/8", 1-3/4", 2", 2-1/2"
 Standard Arbors: 2L, 5L
 One pilot drill
 One Arbor adaptor
LARGE KIT



308021200L
17 PIECE KIT
 3/4", 7/8", 1-1/8", 1-3/8", 1-3/4", 2",
 2-1/2", 2-11/16", 3", 3-5/8", 4-1/8", 4-3/4"
 Standard Arbors: 2L, 5L
 Three pilot drills
LARGE KIT



1815139
8 PIECE KIT
 7/8", 1-1/8", 1-3/8", 1-3/4", 2", 2-1/2"
 Standard Arbors: 2L, 5L
MINI KIT

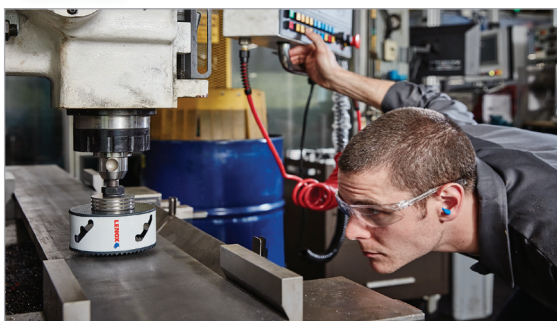

PLUMBER'S KITS



30860C600P
9 PIECE KIT
 3/4", 7/8", 1-1/8", 1-3/8", 2", 2-1/2"
 Standard Arbors: 2L, 5L
 One Arbor adaptor
MEDIUM KIT



30808600P
10 PIECE KIT
 3/4", 7/8", 1-1/8", 1-1/2", 1-3/4", 2-1/4"
 Standard Arbors: 2L, 5L
 One pilot drill
 One Arbor adaptor
LARGE KIT



1853786
10 PIECE KIT
 2-1/8", 2-1/4", 2-9/16", 2-3/4",
 3-5/8", 4", 4-5/8"
 Standard Arbor: 2L
 Two pilot drills
LARGE KIT



308011200P
17 PIECE KIT
 3/4", 7/8", 1-1/8", 1-1/2", 1-3/4", 2-1/4",
 2-9/16", 3", 3-1/2", 4", 4-1/4", 4-1/2"
 Standard Arbors: 2L, 5L
 Three pilot drills
LARGE KIT



1815195
7 PIECE KIT
 1-1/4", 1-3/8", 1-1/2", 2", 2-1/2"
 Standard Arbors: 2L, 5L
MINI KIT

REFRIGERATION KIT



30830600R
8 PIECE KIT
 5/8", 7/8", 1-1/8"
 1-3/8", 1-5/8", 2-1/8"
 Standard Arbors:
 5L, 6L
MEDIUM KIT

WELDER'S KIT



14789600W
9 PIECE KIT
 3/4", 7/8", 1", 1-1/4",
 1-1/2", 2"
 Standard Arbors:
 2L, 5L
 One Arbor adaptor
MEDIUM KIT

AUTOMOTIVE KIT



30805500A
7 PIECE KIT
 3/4", 7/8", 1",
 1-1/8", 1-1/4"
 Standard Arbor: 5L
 One Arbor adaptor
COMPACT KIT



SNAP-BACK™ ARBORS

No Tools. No Adaptors. No Screwing Around.

QUICK CHANGE

Faster and easier to engage/disengage hole saw

PREVENTS THREADS FROM STRIPPING

Drives off pins, not threads

NO TOOLS NEEDED

Prevents hole saw from locking on arbor

NO ADAPTOR REQUIRED

Standard Arbor threads directly into all hole saws

EASIER PLUG REMOVAL



Pull

Twist

Snap

PROD NO	DESC	FITS HOLE SAWS	SIZES		THREAD SIZE	SHANK TYPE	SHANK SIZE	
			IN	MM			IN	MM
1779772	2L	20L-96L	1-1/4-6	31.8-152.4	5/8-18	Solid Hex	1/2 & larger	12.7 & larger
1779669	5L	9L-19L	9/16-1-3/16	14-30	1/2-20	Solid Hex	3/8 & larger	9.5 & larger
1779670	6L	20L-96L	1-1/4-6	31.8-152.4	5/8-18	Solid Hex	3/8 & larger	9.5 & larger

Solid Hex



2L



5L



6L

SNAP-BACK QUICK CHANGE EXTENSIONS

DURABILITY AND EXTENDED LIFE

Carbon steel collar and shaft for durability and extended life

ONE-HANDED RELEASE

SNAP-BACK Quick Change mechanism for quick and easy release

BIT HELD SECURELY IN PLACE

Holds bits securely on ball detent bits (Quick Change)

1/4" extension works with 1/4" arbors and insert bits.

It is magnetic for additional holding power

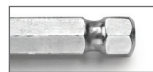

Quick Change Shank



1852050

1906836

1852047

1852048

1852049

PROD NO	IN	MM	CHUCK SIZE		FITS ARBOR	
			IN	MM	SNAP-BACK	STANDARD
1852050	5-1/2	140	7/16	11	2L	1L, 2L, 3L
1906836	12	305	1/4	6.4	—	4L
1852047	12	305	3/8	9.5	5L, 6L	5L, 6L, 7L
1852048	12	305	7/16	11	2L	1L, 2L, 3L
1852049	18	457	7/16	11	2L	1L, 2L, 3L

STANDARD ARBORS & ACCESSORIES

Arbors & Accessories for All Your Drilling Needs

ADDED DURABILITY

Hardened carbon steel for strength

STARTS ON CONTACT

Split point pilot drill for faster penetration and less walking



LENOX 6L Standard Arbor with quick change feature (1779805)

PROD NO	DESC	FITS HOLE SAWS	SIZES		SHANK TYPE	SHANK SIZE		PRIMARY FEATURE
			IN	MM		IN	MM	
1779774	1L	9L-19L	9/16-1-3/16	14.3-30.2	Hollow Hex	1/2 & larger	12.7 & larger	Adjustable pilot bit
1779801	2L	20L-96L	1-1/4-6	31.8-152.4	Solid Hex	1/2 & larger	12.7 & larger	Use for enlarging holes
1779802	3L	20L-96L	1-1/4-6	31.8-152.4	Solid Hex	1/2 & larger	12.7 & larger	Solid shank
1779803	4L	9L-19L	9/16-1-3/16	14.3-30.2	3 Sided	1/4 & larger	6.4 & larger	Adjustable pilot bit, 3 flats on shank
1779804	5L	9L-19L	9/16-1-3/16	14.3-30.2	Hex	3/8 & larger	9.5 & larger	Use for 9A-19A arbored hole saws
1779805	6L	20L-96L	1-1/4-6	31.8-152.4	Hex	3/8 & larger	9.5 & larger	Quick change arbor
1779806	7L	24L-96L	1-1/2-6	31.8-152.4	Hex	3/8 & larger	9.5 & larger	Plug ejection feature

PROD NO	DESCRIPTION	CHUCK SIZE		FITS ARBOR	
		IN	MM	SNAP BACK	SOLID HEX
1779771	4-1/4" Pilot Drill (1 pack)	1/4	6.4	—	1L, 4L
1779841	4-1/4" Pilot Drill (25 pack)	1/4	6.4	—	1L, 4L
1779810	3-1/4" Pilot Drill (1 pack)	1/4	6.4	2L, 5L, 6L	2L, 3L, 5L, 6L, 7L
1864904	3-1/4" Pilot Drill (25 pack)	1/4	6.4	2L, 5L, 6L	2L, 3L, 5L, 6L, 7L
30297123CT	Carbide Tipped Pilot Drill (1 pack)	1/4	6.4	—	1L, 4L
3029865CTPD	Carbide Tipped Pilot Drill (1 pack)	1/4	6.4	2L, 5L, 6L	2L, 3L, 5L, 6L, 7L
30857AA1	Standard Arbor Adaptor (1 pack)	—	—	5L	1L, 4L, 5L
3084818X	18" Extension (1 pack)	1/2 & larger	12.7 & larger	2L	1L, 2L, 3L
3084712X	12" Extension (1 pack)	1/2 & larger	12.7 & larger	2L	1L, 2L, 3L
3084310X*	10" Extension (1 pack)	3/8 & larger	9.5 & larger	5L, 6L	5L, 6L, 7L
3084655X	5-1/2" Extension (1 pack)	1/2 & larger	12.7 & larger	2L	1L, 2L, 3L
2910114	1/4" x 1/4" Set Screw	—	—	2L, 5L, 6L	2L, 3L, 5L, 6L, 7L
29102516	5/16" x 5/16" Set Screw	—	—	—	1L, 4L, Extension
3087935PD	1/4" Split point stubby pilot bit	—	—	—	—
308803CHCAS	Plug ejection springs	—	—	—	—

* Fits arbored hole saws

ACCESSORIES

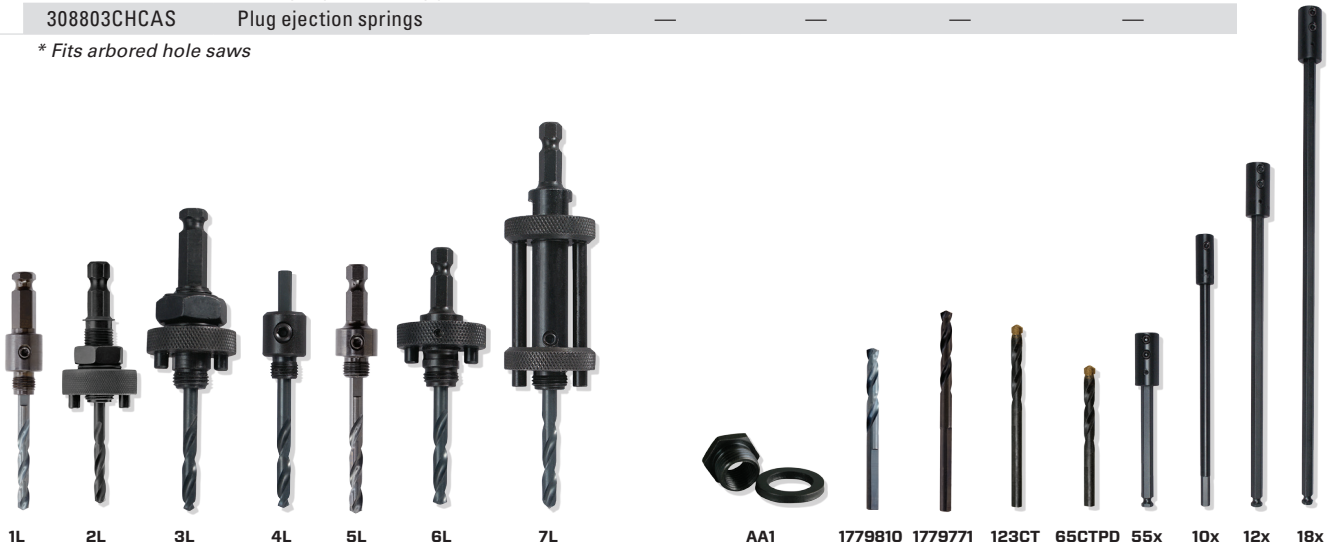



LENOX *DIAMOND*™ HOLE SAWS

More Holes. Less Time.

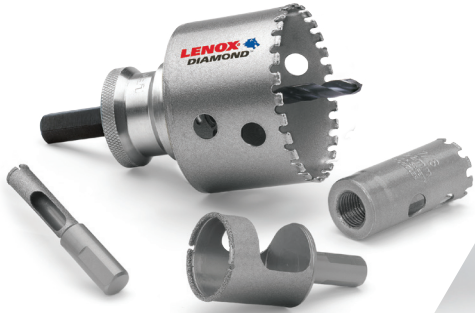

NEW

LENOX DIAMOND™ HOLE SAWS

More Holes. Less Time.

LONG LASTING

Continuous, brazed edge lasts longer in tile and stone

DURABLE

Robust design for greater durability in tough applications

FAST, EASY CUTTING

Low torque, little pressure required

EASIER PLUG REMOVAL

Over-sized slot in hole saw for easy plug removal

USE STANDARD ARBOR, SNAP-BACK™ ARBOR FOR BEST RESULTS USE THE LENOX ARBOR WITH RETRACTABLE PILOT DRILL



ONE PIECE HOLE SAWS

1 PER PACK PROD NO	IN	MM	PIPE TAP		PIPE ENTRANCE		RPM*	
			IN	MM	IN	MM	IN	MM
121063DGDS	3/16	5	—	—	—	—	1500	2000
121074DGDS	1/4	6	—	—	—	—	2000	2500
121085DGDS	5/16	8	—	—	—	—	2000	2500
121096DGDS	3/8	10	—	—	—	—	2000	2500
121108DGDS	1/2	13	—	—	—	—	2000	2500
1211110DGDS	5/8	16	—	—	—	—	1500	2000
1211212DGDS	3/4	19	3/4	13	3/8	10	1500	2000
1211416DGDS	1	25	—	—	—	—	—	—
1211622DGDS	1-3/8	35	—	—	1	25	—	—
12158DGDS4A	4 pc kit Sizes: 3/16", 1/4", 5/16", 3/8"							



STANDARD HOLE SAWS

1 PER PACK PROD NO	IN	MM	PIPE TAP		PIPE ENTRANCE		USE ARBOR			RPM*	
			IN	MM	IN	MM	RETRACTABLE	SNAP-BACK	STANDARD	IN	MM
1211314DGHS	7/8	22	3/4	19	1/2	13	—	5L	1L, 4L, 5L	800	1200
1225618DGHS	1-1/8	29	1	25	3/4	19	—	5L	1L, 4L, 5L	500	900
1211520DGHS	1-1/4	32	—	—	—	—	5L 5/8-18	2L, 6L	2L, 3L, 6L	500	900
1211722DGHS	1-3/8	35	—	—	1	25	5L 5/8-18	2L, 6L	2L, 3L or 6L	500	900
1211824DGHS	1-1/2	38	1-1/4	32	—	—	5L 5/8-18	2L, 6L	2L, 3L, 6L, 7L	500	900
1211932DGHS	2	51	—	—	1-1/2	38	5L 5/8-18	2L, 6L	2L, 3L, 6L, 7L	400	800
1212040DGHS	2-1/2	64	—	—	2	51	5L 5/8-18	2L, 6L	2L, 3L, 6L, 7L	200	600

*Suggested RPMs only: Porcelain, Ceramic, Slate, Granite, Marble, Glass, Fiberglass, Travertine, Cement Board, Laminates

NEW

ARBOR WITH RETRACTABLE PILOT DRILL

CENTERING PIN ELIMINATES WALKING

CARBIDE TIPPED FOR LONGER LIFE



PROD NO	DESC	FITS DIAMOND HOLE SAWS	SIZES		SHANK TYPE	SHANK SIZE	
			IN	MM		IN	MM
1970538	5L 5/8-18	Standard	1-1/4-2-1/2	32-64	Solid Hex	3/8 & larger	9.5 & larger

PROD NO	DESCRIPTION	CHUCK SIZE		FITS ARBOR SOLID HEX
		IN	MM	
1970540	Retractable Pilot Drill	1/4	6.4	5L 5/8-18

LENOX DIAMOND KIT



**1853785
10 PIECE KIT**

1/4", 3/4", 7/8", 1-1/8", 1-3/8",
2", 2-1/2"

Arbors: 2L, 5L. Hex Wrench

LARGE KIT



CARBIDE GRIT HOLE SAWS

Best for Cutting Abrasive Materials

CUTS ABRASIVE MATERIALS

Tungsten carbide grit cuts through fiberglass, ceramic tile, laminates and other abrasive materials

CLEAN CUTTING

Carbide grit edge will not snag or chip when cutting thin materials

USE STANDARD ARBOR OR SNAP-BACK™ ARBOR



1 PER BOX	DIAMETER		PIPE TAP		PIPE ENTRANCE		USE ARBOR		RECOMMENDED RPM ONLY		
	IN	MM	IN	MM	IN	MM	SNAP-BACK	STANDARD	BRICK, DRYWALL, PORCELAIN, MARBLE, CERAMIC TILE	SLATE, FIBERGLASS, PARTICLE BOARD, LAMINATES, GRANITE, CEMENT	CAST IRON
2991212CG	3/4	19.1	1/2	12.7	3/8	9.5	—	1L, 4L	800	900	600
2999820MMCG	25/32	19.8	—	—	—	—	—	1L, 4L	800	900	600
2991414CG	7/8	22.2	3/4	19.1	1/2	12.7	—	1L, 4L	800	900	600
2991616CG	1	25.4	—	—	—	—	—	1L, 4L	800	900	600
2991818CG	1-1/8	28.6	1	25.4	3/4	19.1	—	1L, 4L	500	600	400
2992020CG	1-1/4	31.8	—	—	—	—	2L	2L	500	600	400
2992222CG	1-3/8	34.9	—	—	1	25.4	2L	2L	500	600	400
2992424CG	1-1/2	38.1	1-1/4	31.8	—	—	2L	2L, 7L	500	600	400
2992828CG	1-3/4	44.5	1-1/2	38.1	1-1/4	31.8	2L	2L, 7L	500	600	400
2993232CG	2	50.8	—	—	1-1/2	38.1	2L	2L, 7L	400	500	200
2993434CG	2-1/8	54	—	—	—	—	2L	2L, 7L	400	500	200
2993636CG	2-1/4	57.2	2	50.8	—	—	2L	2L, 7L	400	500	200
2993838CG	2-3/8	60.3	—	—	—	—	2L	2L, 7L	200	300	100
2994040CG	2-1/2	63.5	—	—	2	50.8	2L	2L, 7L	200	300	100
2994141CG	2-9/16	65.1	—	—	—	—	2L	2L, 7L	200	300	100
2994848CG	3	76.2	—	—	2-1/2	63.5	2L	2L, 7L	200	300	100
2995252CG	3-1/4	82.6	3	76.2	—	—	2L	2L, 7L	200	300	100
2995858CG	3-5/8	92.1	—	—	3	76.2	2L	2L, 7L	100	200	100
2996464CG	4	101.6	—	—	—	—	2L	2L, 7L	100	200	100
2996666CG	4-1/8	104.8	—	—	3-1/2	88.9	2L	2L, 7L	100	200	100

PLUMBER'S KIT



29984600CGP
9 PIECE

3/4", 7/8", 1-1/8", 1-1/2",
2-1/8", 2-9/16"

Arbors: 1L, 2L

One arbor adaptor

MEDIUM KIT

CONTRACTOR'S KIT



29985700CGK
10 PIECE

7/8", 1", 1-1/4", 1-3/8", 1-1/2",
1-3/4", 2-1/8"

Arbors: 1L, 2L

One arbor adaptor

MEDIUM KIT



CARBIDE TIPPED HOLE SAWS

Designed for Cutting Tile and Stainless Steel

LONG TOOL LIFE

Heat resistant carbide teeth for long life in tile and stainless steel

ADDED DURABILITY

Thick backing plate resists damage and increases life

UNIQUE TOOTH CONFIGURATION

Engineered design provides ability to cut in stainless steel like no other

USE STANDARD ARBOR OR SNAP-BACK™ ARBOR



1 PER PACK	DIAMETER		PIPE TAP		PIPE ENTRANCE		USE ARBOR		RECOMMENDED RPM				
	IN	MM	IN	MM	IN	MM	SNAP-BACK	STANDARD	ALUM	STAINLESS STEEL	FIBER-GLASS	CERAMIC TILE	CAST IRON
3021111CT	11/16	17.5	—	—	—	—	5L	1L,4L,5L	—	—	—	—	—
3021212CT	3/4	19.1	1/2	12.7	3/8	9.5	5L	1L,4L,5L	1700	410	250	500	410
3021414CT	7/8	22.2	3/4	19.1	1/2	12.7	5L	1L,4L,5L	1500	180	210	430	180
3021616CT	1	25.4	—	—	—	—	5L	1L,4L,5L	1300	150	190	370	150
3021818CT	1-1/8	28.6	1	25.4	3/4	19.1	5L	1L,4L,5L	1100	140	170	330	140
3022020CT	1-1/4	31.8	—	—	—	—	2L	2L,3L,6L	—	—	—	—	—
3022222CT	1-3/8	34.9	—	—	1	25.4	2L	2L,3L,6L	900	110	140	270	110
3022424CT	1-1/2	38.1	1-1/4	31.8	—	—	2L	2L,3L,6L,7L	900	110	140	270	110
3022626CT	1-5/8	41.3	—	—	—	—	2L	2L,3L,6L,7L	—	—	—	—	—
3022828CT	1-3/4	44.5	1-1/2	38.1	1-1/4	31.8	2L	2L,3L,6L,7L	700	90	110	210	90
3023232CT	2	50.8	—	—	1-1/2	38.1	2L	2L,3L,6L,7L	600	80	90	190	80
3023434CT	2-1/8	54.0	—	—	—	—	2L	2L,3L,6L,7L	—	—	—	—	—
3023636CT	2-1/4	57.2	2	50.8	—	—	2L	2L,3L,6L,7L	600	70	80	170	70
3023838CT	2-3/8	60.3	—	—	—	—	2L	2L,3L,6L,7L	—	—	—	—	—
3024040CT	2-1/2	63.5	—	—	2	50.8	2L	2L,3L,6L,7L	500	60	70	150	60
3024141CT	2-9/16	65.1	—	—	—	—	2L	2L,3L,6L,7L	—	—	—	—	—
3024242CT	2-5/8	66.7	2-1/2	63.5	—	—	2L	2L,3L,6L,7L	—	—	—	—	—
3024343CT	2-11/16	68.3	—	—	—	—	2L	2L,3L,6L,7L	—	—	—	—	—
3024848CT	3	76.2	—	—	2-1/2	63.5	2L	2L,3L,6L,7L	400	50	60	120	50
3025252CT	3-1/4	82.6	3	76.2	—	—	2L	2L,3L,6L,7L	400	50	60	120	50
3025454CT	3-3/8	85.7	—	—	—	—	2L	2L,3L,6L,7L	—	—	—	—	—
3025656CT	3-1/2	88.9	—	—	—	—	2L	2L,3L,6L,7L	—	—	—	—	—
3025858CT	3-5/8	92.1	—	—	3	76.2	2L	2L,3L,6L,7L	400	40	50	100	40
3026060CT	3-3/4	95.3	3-1/2	88.9	—	—	2L	2L,3L,6L,7L	300	40	50	100	40
3026464CT	4	101.6	—	—	—	—	2L	2L,3L,6L,7L	—	—	—	—	—
3026666CT	4-1/8	104.8	—	—	3-1/2	88.9	2L	2L,3L,6L,7L	300	40	50	90	40
3026868CT	4-1/4	108.0	4	101.6	—	—	2L	2L,3L,6L,7L	—	—	—	—	—
3027272CT	4-1/2	114.3	—	—	—	—	2L	2L,3L,6L,7L	—	—	—	—	—
3027676CT	4-3/4	120.7	4-1/2	114.3	4	101.6	2L	2L,3L,6L,7L	300	30	40	80	30
3028080CT	5	127.0	—	—	—	—	2L	2L,3L,6L,7L	200	30	40	80	30
3028888CT	5-1/2	139.7	—	—	—	—	2L	2L,3L,6L,7L	200	30	40	70	30
3029696CT	6	152.4	—	—	—	—	2L	2L,3L,6L,7L	100	30	30	60	30

Note: We recommend the use of a carbide tipped pilot drill when cutting ceramic tile. Pilot drill 123CT fits the SNAP-BACK 2L or standard arbors 1L, 2L, 4L or 7L. Pilot drill 65CTPD fits the SNAP-BACK 2L or standard arbors 5L and 6L.

PLUMBER'S KIT



**30294600CTP
8 PIECE**
3/4", 7/8", 1-1/8",
1-1/2", 1-3/4", 2-1/4"
Arbors: 1L, 2L
MEDIUM KIT

ELECTRICIAN'S KIT



**30295600CTL
8 PIECE**
7/8", 1-1/8", 1-3/8",
1-3/4", 2" 2-1/2"
Arbors: 1L, 2L
MEDIUM KIT

CONTRACTOR'S KIT



**302901100CTG
15 PIECE**
3/4", 7/8", 1", 1-1/8", 1-1/4",
1-3/8", 1-1/2", 1-3/4", 2",
2-9/16", 3". Arbors: 1L, 2L
Two pilot drills
LARGE KIT



CARBIDE HOLE CUTTERS

Designed Specifically for Sheet Metal Hole Cutting

ACCURATE, BURR-FREE HOLES

Precision ground carbide teeth for fast cutting of clean, round holes

WILL NOT DAMAGE WORK

Over-drill stopper prevents the tool from penetrating beyond the hole

STARTS ON CONTACT

Split point pilot bit for faster penetration and less walking

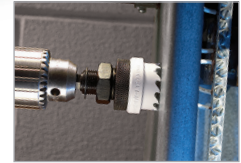

1 PER BOX PROD NO	DIAMETER		CONDUIT SIZE	USE ARBOR	
	IN	MM		SNAP-BACK	STANDARD
2009212CHC	3/4	19.1	3/8"	5L	5L
2009314CHC	7/8	22.2	1/2"	5L	5L
2009416CHC	1	25.4	—	5L	5L
2009618CHC	1-1/8	28.6	3/4"	5L	5L
20097195CHC	1-7/32	30.9	—	5L	5L
2009820CHC	1-1/4	31.8	—	—	3L, 6L
2010022CHC	1-3/8	34.9	1"	—	3L, 6L
2010224CHC	1-1/2	38.1	—	—	3L, 6L
2010328CHC	1-3/4	44.5	1-1/4"	—	3L, 6L
2010432CHC	2	50.8	1-1/2"	—	3L, 6L
2010534CHC	2-1/8	54.0	—	—	3L, 6L
2010840CHC	2-1/2	63.5	2"	—	3L, 6L
2010942CHC	2-5/8	66.7	—	—	3L, 6L
2011344CHC	2-3/4	69.9	—	—	3L, 6L
2011448CHC	3	76.2	2-1/2"	—	3L, 6L
3087935PD	1/4" Split point stubby pilot bit		—	—	—
308803CHCAS	Plug ejection springs		—	—	—

ELECTRICIAN'S KITS



30877300CHC 12 PIECE KIT

7/8", 1-1/8", 1-3/8". Arbors: 3L, 5L
1/4" split point pilot bit. Plug ejection
springs, 1/8" hex wrench

COMPACT KIT



30878500CHC 15 PIECE KIT

7/8", 1-1/8", 1-3/8", 1-3/4", 2", 2-1/2"
Arbors: 3L, 5L. 1/4" split point pilot bit
Plug ejection springs, 1/8" hex wrench

MEDIUM KIT

CARBIDE GRIT RECESSED LIGHTING HOLE SAWS

Best for Cutting Abrasive Materials

LONG LIFE

Hard tungsten carbide grit edge for a long life in abrasive materials

FAST, EASY CUTTING

Continuous cutting edge for smooth cutting

LIMITS DUST / DEBRIS

Solid back design collects dust and debris



1 PER BOX PROD NO	DIAMETER		FOR FIXTURES	USE ARBOR	
	IN	MM		SNAP-BACK	STANDARD
30861438RL	4-3/8	111	Capri, Marco, Halo, Mini-Juno	2L	2L
12100538RL	5-3/8	137	Capri, Marco, Halo, Mini-Juno, Lightolier®	2L	2L
30862638RL	6-3/8	162	Capri, Halo, Pathway & Thomas	2L	2L
30863658RL	6-5/8	168	Juno, Progress & Pathway	2L	2L
30864678RL	6-7/8	175	Capri, Hubbell®, Lightolier®, Lithonia®, Marco, Prescolite®, & Progress	2L	2L

Use 123CT or 1779771 Pilot Drill

HALO is a registered trademark of Halo Lighting, JUNO is a registered trademark of Juno Lighting Inc., LITHONIA is a registered trademark of Lithonia, Inc., LIGHTOLIER is a registered trademark of Lightolier, Inc., and PRESCOLITE is a registered trademark of Prescolite, Inc.

ONE TOOTH® ROUGH WOOD HOLE CUTTER

Drills Faster Than Self-Feed Bits

LONG LASTING

High speed steel tooth provides long tool life

CUTS FAST / LOW TORQUE

Designed to run at high speeds with very little torque

DURABLE WOOD CUTTING TOOL

Cuts wet, frozen, pressure treated and hard wood without binding

EASY PLUG REMOVAL

Patented design allows easy plug removal

CUTS AT AN ANGLE

Unique design provides the ability to cut at an angle

USE STANDARD ARBOR OR SNAP-BACK™ ARBOR

For optimal performance use a 3/8" Stubby Spade Bit with Standard Arbor



1 PER PACK PROD NO	CUTTER SIZE		CUTTING DEPTH		APPLICATION	USE ARBOR	
	IN	MM	IN	MM		SNAP-BACK	STANDARD
2542222HC	1-3/8	34.9	2-7/16"	62	1" pipe & lock installation	2L	2L, 3L
2543434HC	2-1/8	54.0	2-7/16"	62	1-1/2" pipe & lock installation	2L	2L, 3L
2543636HC	2-1/4	57.2	2-7/16"	62	1-1/2" pipe & 45°/90° bend couplings	2L	2L, 3L
2544141HC	2-9/16	65.1	2-7/16"	62	2" pipe	2L	2L, 3L
2544444HC	2-3/4	69.9	2-7/16"	62	2" pipe & 45°/90° bend couplings	2L	2L, 3L
2545454HC	3-3/8	85.7	2-7/16"	62	3" duct pipe & bendable duct pipe	2L	2L, 3L
2545656HC	3-5/8	92.1	2-7/16"	62	3" pipe	2L	2L, 3L
2546464HC	4	101.6	2-7/16"	62	3" pipe & coupling & dryer vent	2L	2L, 3L
2546969HC	4-5/16	109.5	2-7/16"	62	4" duct pipe & bendable duct pipe	2L	2L, 3L
2547474HC	4-5/8	117.5	2-7/16"	62	4" pipe	2L	2L, 3L
2548080HC	5	127.0	2-7/16"	62	4" pipe & coupling	2L	2L, 3L
2548787HC	5-1/2	139.7	2-7/16"	62	Toilet flange	2L	2L, 3L
2550000HC	6-1/4	158.8	2-7/16"	62	6" duct pipe	2L	2L, 3L
25310SB38	—	—	—	—	3/8" stubby spade bit	2L	2L, 3L
25312DIAF1	—	—	—	—	Diamond file for re-sharpening	—	—

ONE TOOTH HOLE CUTTER KITS



25476301G 7 PIECE

2-1/8", 2-9/16", 3-5/8"
Arbor: 2L, Diamond file
Two 3/8" stubby spade bits

LARGE KIT



25477701G 11 PIECE

2-1/8", 2-1/4", 2-9/16", 2-3/4",
3-5/8", 4", 4-5/8"

Arbor: 2L, Diamond file
Two 3/8" stubby spade bits

LARGE KIT





 facebook.com/lenoxtools

 twitter.com/lenoxtools

 youtube.com/lenoxtools

Customer Service: 800-628-8810
Technical Support: 800-642-0010
lenoxtools.com

LENX1082
301 Chestnut Street, East Longmeadow, MA 01028-0504 USA
©2016 LENOX, Newell Brands