

## Low Profile Design Combines Functionality With Aesthetics Ideal for Low Voltage and Power Applications

400, 800, 2300 and 2300BACD Series™ Raceway, are a family of low-profile raceways that are designed for communication or power applications. 400, 800 and 2300 Raceway offer a single channel for either communication or power. And when power and low voltage services are both needed in a single raceway, the divided 2300BACD Raceway with its low-profile design, is an easy-to-install option.

400,800,2300 and 2300BACD Raceways are an ideal solution for use in classrooms, offices, hospitality applications, or anywhere a small, secure, low profile raceway is needed.



2300D Series Raceway in a typical office application.

### FEATURES & BENEFITS

- **Accommodates communication and/or power wiring.** Can be used for communications, computer lines, surveillance systems, fire alarms, outlets, and more.
- **Available in three sizes.** 400, 800, and 2300 sizes provide flexibility for meeting a variety of capacity and space requirements. Perfect for most small drops and horizontal runs to work stations.
- **Durable, textured PVC construction.** Available in ivory or white finish to blend with any decor. Also paintable using latex paint. Consult factory for custom color options.
- **Single- and dual-compartment low profile design.** Provides functionality and flexibility with aesthetics for single- or dual-service applications.
- **Adhesive backing for low voltage (under 50V) applications.** Allows base to be pressed onto mounting surface. Speeds installation.
- **Lightweight and easy to handle.** Saves time and labor costs. Standard 5' (1.525m) raceway lengths can be easily installed by one person. Custom lengths up to 10' (3.05m) are also available.
- **Divided FiberReady® fittings.** For use with 2300BAC and 2300BACD. Full capacity fittings provide 2" (51mm) bend radius.
- **Over-the-raceway box for 2300 and 2300D.** Boxes mount over continuous run of raceway base eliminating the need to cut raceway when locating devices.
- **Sure-Snap® boxes for 2300BACD.** Provides flush look and ease of installation.
- **Snap-on cover.** Provides security with access to wiring for changes or additions.
- **Datacom connectivity options.** Accepts industry standard and proprietary devices from a wide range of manufacturers to provide a seamless and aesthetically pleasing interface for voice, data, audio, and video applications at the point of use.
- **cULus Listed.** File E90378 Raceway, E90377 Fittings.



PEP  
ECO  
PASS  
PORT

Download this product's PEP ecopassport® environmental product declaration at [www.legrand.us/resources-and-downloads](http://www.legrand.us/resources-and-downloads). This declaration conforms with ISO 14025 and 14040 and is in alignment with EN 15804.

## 400, 800, 2300, 2300D Series Raceway System Layout



NOTE: Illustration shows product applications only. 2315 Tee Fitting cannot be used with 2300D Divided Raceway.

### 400, 800, 2300, 2300D Raceway Series Wire Fill Capacities for Power

| WIRE SIZE<br>THHN/THWN | O.D.   |       | NUMBER OF CONDUCTORS |        |         |                       |
|------------------------|--------|-------|----------------------|--------|---------|-----------------------|
|                        | Inches | (mm)  | 400BAC               | 800BAC | 2300BAC | 2300BACD <sup>†</sup> |
| 14 AWG                 | 0.111  | (2.8) | 5                    | 6      | 15      | 7                     |
| 12 AWG                 | 0.130  | (3.3) | 3                    | 5      | 14      | 6                     |
| 10AWG                  | 0.164  | (4.2) | 0                    | 4      | 12      | 5                     |

### 400, 800, 2300, 2300D Raceway Series Wire Fill Capacities for Communications

|                            | CABLE/WIRE SIZE          | O.D.    |        | 40% FILL* |     |      |                    |
|----------------------------|--------------------------|---------|--------|-----------|-----|------|--------------------|
|                            |                          | inches  | (mm)   | 400       | 800 | 2300 | 2300D <sup>†</sup> |
| UNSHIELDED<br>TWISTED PAIR | 4-Pair, 24 AWG Cat. 3    | 0.190   | (4.8)  | 1         | 3   | 11   | 5                  |
|                            | 4-Pair, 24 AWG Cat. 5e   | 0.210   | (5.3)  | 1         | 3   | 9    | 4                  |
|                            | 4-Pair, 24 AWG Cat. 6    | 0.250   | (6.3)  | 1         | 2   | 6    | 3                  |
|                            | 4-Pair, 24 AWG Cat. 6a** | 0.354   | (9.0)  | 0         | 1   | 3    | 1                  |
|                            | 25-Pair, 24 AWG          | 0.410   | (10.4) | 0         | 0   | 2    | 1                  |
| COAXIAL                    | RG6/U                    | 0.270   | (6.9)  | 0         | 1   | 5    | 2                  |
| FIBER                      | Zip Cord 0.118 x 0.157   | (3 x 6) | 1      | 3         | 12  | 6    |                    |
|                            | Round 4 Strand Fiber     | 0.187   | (4.8)  | 1         | 3   | 12   | 6                  |
|                            | Round 6 Strand Fiber     | 0.256   | (6.5)  | 1         | 2   | 6    | 3                  |

\* Wire capacity is reduced to allow for proper conductor bend radius and maximum permissible heat rise.

\*\* Category 6 augmented (6a) cable for 10 gigabit ethernet - max allowed cable diameter per addenda No. 11 ANSI TIA/EIA 568-B.2.

<sup>†</sup> each compartment.

### 400BAC, 800BAC, 2300BAC, 2300BACD Series Raceway Ordering Information

| Catalog No./Item   | Description/Specifications   |
|--|--|
| <b>400BAC</b> <b>400BAC-WH</b><br><b>800BAC</b> <b>800BAC-WH</b><br><b>2300BAC</b> <b>2300BAC-WH</b><br><b>2300BACD</b> <b>2300BACD-WH</b> | <b>Low profile, two-piece raceway with snap-on cover</b> – Available in 5' (1.525m) and length.<br>Supplied with wide adhesive tape along entire length of base. |
|   |   |
|    |   |

## 400, 800, 2300, 2000D Series Fittings Ordering Information

| Catalog No./Item  | Description/Specifications  |               |             |       |                 |       |                 |               |             |      |               |               |             |       |               |           |             |
|---|---|---------------|-------------|-------|-----------------|-------|-----------------|---------------|-------------|------|---------------|---------------|-------------|-------|---------------|-----------|-------------|
| <b>400WC</b><br><b>800WC</b><br><b>2300WC</b>  | <b>Wire Clip</b> – For holding conductors in place. <table border="1" style="margin-top: 10px;"> <thead> <tr> <th>CAT NO.</th> <th>A</th> </tr> </thead> <tbody> <tr> <td>400WC</td> <td>1/2" (12.7mm)</td> </tr> <tr> <td>800WC</td> <td>1" (25mm)</td> </tr> <tr> <td>2300WC</td> <td>1" (25mm)</td> </tr> </tbody> </table>  | CAT NO.       | A           | 400WC | 1/2" (12.7mm)   | 800WC | 1" (25mm)       | 2300WC        | 1" (25mm)   |      |               |               |             |       |               |           |             |
| CAT NO.   | A   |               |             |       |                 |       |                 |               |             |      |               |               |             |       |               |           |             |
| 400WC   | 1/2" (12.7mm)   |               |             |       |                 |       |                 |               |             |      |               |               |             |       |               |           |             |
| 800WC   | 1" (25mm)   |               |             |       |                 |       |                 |               |             |      |               |               |             |       |               |           |             |
| 2300WC  | 1" (25mm)   |               |             |       |                 |       |                 |               |             |      |               |               |             |       |               |           |             |
| <b>406</b><br><b>806</b><br><b>2306</b>        | <b>Cover Clip</b> – For covering joint where two pieces of 400BAC, 800BAC or 2300BAC Series Raceway cover come together. <table border="1" style="margin-top: 10px;"> <thead> <tr> <th>CAT NO.</th> <th>A</th> </tr> </thead> <tbody> <tr> <td>406</td> <td>13/16" (20.6mm)</td> </tr> <tr> <td>806</td> <td>1" (25mm)</td> </tr> <tr> <td>2306</td> <td>2" (51mm)</td> </tr> </tbody> </table>   | CAT NO.       | A           | 406   | 13/16" (20.6mm) | 806   | 1" (25mm)       | 2306          | 2" (51mm)   |      |               |               |             |       |               |           |             |
| CAT NO.   | A   |               |             |       |                 |       |                 |               |             |      |               |               |             |       |               |           |             |
| 406   | 13/16" (20.6mm)   |               |             |       |                 |       |                 |               |             |      |               |               |             |       |               |           |             |
| 806   | 1" (25mm)   |               |             |       |                 |       |                 |               |             |      |               |               |             |       |               |           |             |
| 2306  | 2" (51mm)   |               |             |       |                 |       |                 |               |             |      |               |               |             |       |               |           |             |
| <b>410B</b><br><b>810B</b><br><b>2310B</b>     | <b>Blank End Fitting</b> – For closing open end of 400BAC, 800BAC, or 2300BAC Raceway Series. <table border="1" style="margin-top: 10px;"> <thead> <tr> <th>CAT NO.</th> <th>A</th> <th>B</th> <th>C</th> </tr> </thead> <tbody> <tr> <td>410B</td> <td>13/16" (20.6mm)</td> <td>1/2" (12.7mm)</td> <td>3/8 (9.5mm)</td> </tr> <tr> <td>810B</td> <td>1 1/4" (32mm)</td> <td>1/2" (12.7mm)</td> <td>3/8 (9.5mm)</td> </tr> <tr> <td>2310B</td> <td>2 1/4" (57mm)</td> <td>1" (25mm)</td> <td>3/8 (9.5mm)</td> </tr> </tbody> </table> | CAT NO.       | A           | B     | C               | 410B  | 13/16" (20.6mm) | 1/2" (12.7mm) | 3/8 (9.5mm) | 810B | 1 1/4" (32mm) | 1/2" (12.7mm) | 3/8 (9.5mm) | 2310B | 2 1/4" (57mm) | 1" (25mm) | 3/8 (9.5mm) |
| CAT NO.   | A   | B             | C           |       |                 |       |                 |               |             |      |               |               |             |       |               |           |             |
| 410B  | 13/16" (20.6mm)   | 1/2" (12.7mm) | 3/8 (9.5mm) |       |                 |       |                 |               |             |      |               |               |             |       |               |           |             |
| 810B  | 1 1/4" (32mm)   | 1/2" (12.7mm) | 3/8 (9.5mm) |       |                 |       |                 |               |             |      |               |               |             |       |               |           |             |
| 2310B   | 2 1/4" (57mm)   | 1" (25mm)     | 3/8 (9.5mm) |       |                 |       |                 |               |             |      |               |               |             |       |               |           |             |
| <b>411*</b>                                  | <b>90° Flat Elbow</b> – For right angle turns on same surface. <p style="margin-top: 10px;">2 1/16" (53mm)<br/>1 3/8" (35mm)</p>  |               |             |       |                 |       |                 |               |             |      |               |               |             |       |               |           |             |
| <b>415*</b>                                  | <b>Tee</b> – For branches at right angles. <p style="margin-top: 10px;">3 3/16" (81mm)    2" (51mm)<br/>1 3/8" (35mm)    2 5/32" (55mm)</p>   |               |             |       |                 |       |                 |               |             |      |               |               |             |       |               |           |             |
| <b>417*</b>                                  | <b>Internal Elbow</b> – For surfaces at right angles. <p style="margin-top: 10px;">1 1/2" (38mm)</p>  |               |             |       |                 |       |                 |               |             |      |               |               |             |       |               |           |             |

**NOTE:** No suffix denotes ivory finish. Add "-WH" suffix for white finish.  
 \* For 2300BAC and 2300BACD Raceway must be mitered to use 2311 and 2318. 2315 cannot be used in divided raceway.

| Catalog No./Item  | Description/Specifications  |                |   |     |               |                |                 |      |               |                |
|---|---|----------------|---|-----|---------------|----------------|-----------------|------|---------------|----------------|
| <b>418</b><br><b>818</b><br><b>2318*</b>  | <b>90° External Elbow</b> – For right angle turns around external corners. <table border="1" style="margin-top: 10px;"> <thead> <tr> <th>CAT NO.</th> <th>A</th> </tr> </thead> <tbody> <tr> <td>418</td> <td>1 1/2" (38mm)</td> </tr> <tr> <td>818</td> <td>2" (51mm)</td> </tr> <tr> <td>2318</td> <td>2 1/2" (64mm)</td> </tr> </tbody> </table> | CAT NO.        | A | 418 | 1 1/2" (38mm) | 818            | 2" (51mm)       | 2318 | 2 1/2" (64mm) |                |
| CAT NO.   | A   |                |   |     |               |                |                 |      |               |                |
| 418   | 1 1/2" (38mm)   |                |   |     |               |                |                 |      |               |                |
| 818   | 2" (51mm)   |                |   |     |               |                |                 |      |               |                |
| 2318  | 2 1/2" (64mm)   |                |   |     |               |                |                 |      |               |                |
| <b>PVC-1</b>                              | <b>PVC Cutter</b> – Regular duty cutter. Ideal for use with small nonmetallic raceway.  |                |   |     |               |                |                 |      |               |                |
| <b>810A2</b>                              | <b>Entrance End Fitting</b> – For connecting 400 or 800 Series Raceway with 1/2" trade size conduit or armored cable. 1/2" trade size KO on end and bottom. <p style="margin-top: 10px;">1 1/2" (38mm)<br/>4 1/4" (108mm)<br/>1 7/16" (37mm)</p>  |                |   |     |               |                |                 |      |               |                |
| <b>811</b><br><b>2311**</b>             | <b>90° Flat Elbow</b> – For right angle turns on same surface. <table border="1" style="margin-top: 10px;"> <thead> <tr> <th>CAT NO.</th> <th>A</th> </tr> </thead> <tbody> <tr> <td>811</td> <td>2 1/2" (64mm)</td> </tr> <tr> <td>2311</td> <td>4 3/16" (106mm)</td> </tr> </tbody> </table>  | CAT NO.        | A | 811 | 2 1/2" (64mm) | 2311           | 4 3/16" (106mm) |      |               |                |
| CAT NO.   | A   |                |   |     |               |                |                 |      |               |                |
| 811   | 2 1/2" (64mm)   |                |   |     |               |                |                 |      |               |                |
| 2311  | 4 3/16" (106mm)   |                |   |     |               |                |                 |      |               |                |
| <b>815</b><br><b>2315**</b>             | <b>Tee</b> – For right angles turns on same surface. <table border="1" style="margin-top: 10px;"> <thead> <tr> <th>CAT NO.</th> <th>A</th> <th>B</th> </tr> </thead> <tbody> <tr> <td>815</td> <td>4 1/8" (105mm)</td> <td>2 3/4" (70mm)</td> </tr> <tr> <td>2315</td> <td>6" (152mm)</td> <td>4 1/8" (105mm)</td> </tr> </tbody> </table>          | CAT NO.        | A | B   | 815           | 4 1/8" (105mm) | 2 3/4" (70mm)   | 2315 | 6" (152mm)    | 4 1/8" (105mm) |
| CAT NO.   | A   | B              |   |     |               |                |                 |      |               |                |
| 815   | 4 1/8" (105mm)  | 2 3/4" (70mm)  |   |     |               |                |                 |      |               |                |
| 2315  | 6" (152mm)  | 4 1/8" (105mm) |   |     |               |                |                 |      |               |                |
| <b>817</b><br><b>2317*</b>              | <b>Internal Elbow</b> – For surfaces at right angles. <table border="1" style="margin-top: 10px;"> <thead> <tr> <th>CAT NO.</th> <th>A</th> </tr> </thead> <tbody> <tr> <td>817</td> <td>2" (51mm)</td> </tr> <tr> <td>2317</td> <td>2 1/2" (64mm)</td> </tr> </tbody> </table>   | CAT NO.        | A | 817 | 2" (51mm)     | 2317           | 2 1/2" (64mm)   |      |               |                |
| CAT NO.   | A   |                |   |     |               |                |                 |      |               |                |
| 817   | 2" (51mm)   |                |   |     |               |                |                 |      |               |                |
| 2317  | 2 1/2" (64mm)   |                |   |     |               |                |                 |      |               |                |
| <b>889A</b>                             | <b>Reducing Connector (800-400)</b> – For transitioning from 800 to 400 Series Raceway. <p style="margin-top: 10px;">1 1/2" (38mm)    2" (51mm)</p>   |                |   |     |               |                |                 |      |               |                |

## 400, 800, 2300, 2000D Series Fittings Ordering Information (continued)

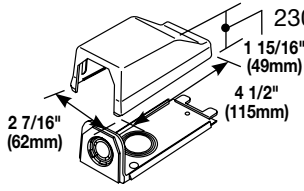
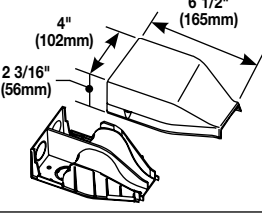
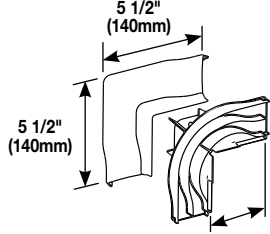
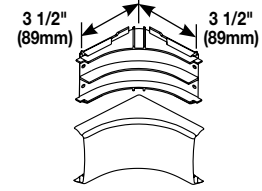
| Catalog No./Item  | Description/Specifications  |
|---|---|
| <b>2310A</b><br>     | <b>Entrance End Fitting</b> – 1/2", 3/4", and 1" trade size KOs for feeding 2300 Series Raceway.  |
| <b>2310DFO</b><br>   | <b>Bend Radius Divided Entrance End Fitting</b> – Divided fitting to feed 2300BAC and 2300BACD Series Raceway. Includes 1/2", 3/4" and 1" trade size KOs on back and top. |
| <b>2311DFO</b><br>   | <b>Bend Radius Divided Flat Elbow</b> – A 90° flat corner with integral dividers to provide 2" (51mm) cable bend radius for UTP and fiber optic installations.            |
| <b>2317DFO</b><br> | <b>Bend Radius Divided Internal Elbow</b> – A 90° internal corner with integral dividers to provide 2" (51mm) cable bend radius for UTP and fiber optic installations.    |

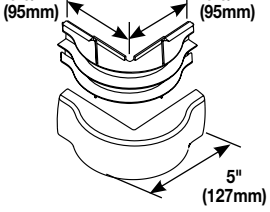
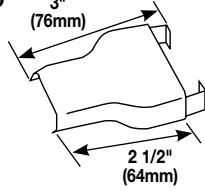
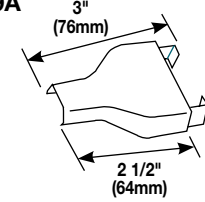
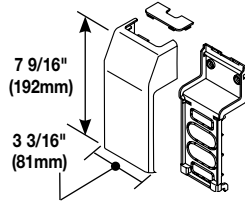
| Catalog No./Item   | Description/Specifications   |
|--|--|
| <b>2318DFO</b><br> | <b>Bend Radius Divided External Elbow</b> – A 90° external corner with integral dividers to provide 2" (51mm) cable bend radius for UTP and fiber optic installations. |
| <b>2389</b><br>    | <b>Reducing Connector (2300BAC-800BAC)</b> – For transitioning from 2300BAC to 800BAC Series Raceway.  |
| <b>2389A</b><br>   | <b>Reducing Connector (2300BAC-400BAC)</b> – For transitioning from 2300BAC to 400BAC Series Raceway.  |
| <b>5474</b><br>   | <b>Transition Tap Fitting</b> – Makes transition from 5400 Raceway to 400BAC, 800BAC, 2300BAC Series Raceway.  |

NOTE: No suffix denotes ivory finish. Add "-WH" suffix for white finish.

## 400, 800, 2300, 2000D Series Communications Boxes Ordering Information (continued)

| Catalog No./Item   | Description/Specifications   |
|--|--|
| <b>CM-MMB-231</b><br> | <b>One Insert Multimedia Box</b> - Compatible with 400BAC and 800BAC Series Raceway. Accepts Pass & Seymour® Activate Inserts and Wiremold Open System Communication Modules.                        |
| <b>CM-MMB-232</b><br> | <b>Two Insert FiberReady® Multimedia Box</b> - Compatible with 400BAC, 800BAC, and 2300BAC Series Raceway. Accepts Pass & Seymour® Activate Inserts and Wiremold Open System Communications Modules. |

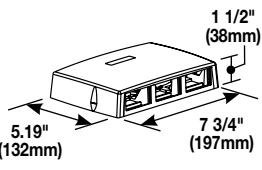
| Catalog No./Item  | Description/Specifications   |
|---|--|
| <b>CM-MMB-233</b><br> | <b>Three-Insert FiberReady® Multimedia Box</b> – Compatible with 400BAC, 800BAC and 2300BAC Series Raceway. Accepts Pass & Seymour® Activate Inserts and Wiremold Open System Communications Modules |

## 400, 800, 2300 Series Raceway Sure-Snap® Device Boxes

- **Interchangeable covers and bases.** Provides installation flexibility.
- **Large knockout.** Accommodates many cable types and quantities.
- **Cover removes easily.** One twist of a screwdriver removes the cover for fast changes.
- **No screws to assemble.** The secure snap assembly requires fewer tools and parts, which means a shorter installation time.



Sure-Snap Device Boxes are available in a variety of sizes and depths.

### 400, 800, 2300 Series Raceway Sure-Snap® Device Boxes Ordering Information (For Non-Divided Raceways)

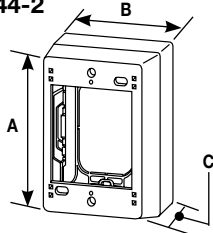
| Catalog No./Item   | Description/Specifications   |                   |                   |                  |   |   |      |   |                   |              |                  |        |   |                   |                   |                  |  |  |  |
|--|--|-------------------|-------------------|------------------|---|---|------|---|-------------------|--------------|------------------|--------|---|-------------------|-------------------|------------------|--|--|--|
| <b>2344</b><br><b>2344-2</b>  | <b>Extra Deep Device Box</b> – 2344 one-gang, 2344-2 two-gang. 2344-2 base has rectangular KO to enable extension from existing single-gang flush wall box and 1/2" and 1" trade size concentric KOs. Accepts NEMA Faceplates  |                   |                   |                  |   |   |      |   |                   |              |                  |        |   |                   |                   |                  |  |  |  |
|  | <table border="1" style="width: 100%; border-collapse: collapse;"> <thead> <tr> <th>CAT #</th> <th>GANG(s)</th> <th>A</th> <th>B</th> <th>C</th> </tr> </thead> <tbody> <tr> <td style="text-align: center;">2344</td> <td style="text-align: center;">1</td> <td style="text-align: center;">4 3/4"<br/>(121mm)</td> <td style="text-align: center;">3"<br/>(76mm)</td> <td style="text-align: center;">2 3/4"<br/>(70mm)</td> </tr> <tr> <td style="text-align: center;">2344-2</td> <td style="text-align: center;">2</td> <td style="text-align: center;">4.3/4"<br/>(121mm)</td> <td style="text-align: center;">4 7/8"<br/>(124mm)</td> <td style="text-align: center;">2 3/4"<br/>(70mm)</td> </tr> </tbody> </table> | CAT #             | GANG(s)           | A                | B | C | 2344 | 1 | 4 3/4"<br>(121mm) | 3"<br>(76mm) | 2 3/4"<br>(70mm) | 2344-2 | 2 | 4.3/4"<br>(121mm) | 4 7/8"<br>(124mm) | 2 3/4"<br>(70mm) |  |  |  |
| CAT #  | GANG(s)  | A                 | B                 | C                |   |   |      |   |                   |              |                  |        |   |                   |                   |                  |  |  |  |
| 2344   | 1  | 4 3/4"<br>(121mm) | 3"<br>(76mm)      | 2 3/4"<br>(70mm) |   |   |      |   |                   |              |                  |        |   |                   |                   |                  |  |  |  |
| 2344-2   | 2  | 4.3/4"<br>(121mm) | 4 7/8"<br>(124mm) | 2 3/4"<br>(70mm) |   |   |      |   |                   |              |                  |        |   |                   |                   |                  |  |  |  |

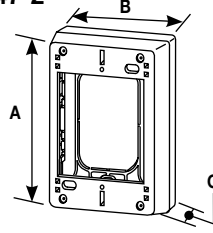
| <b>2347</b><br><b>2347-2</b>  | <b>Device Box</b> – 2347 one-gang, 2347-2 two-gang. For standard switches and devices. 2347 and 2347-2 Bases have rectangular KO to enable extension from existing flush wall box and 1/2" and 1" trade size concentric KOs. Accepts NEMA Faceplates   |                   |                   |                  |   |   |      |   |                   |              |                  |        |   |                   |                   |                  |  |  |  |
|--|--|-------------------|-------------------|------------------|---|---|------|---|-------------------|--------------|------------------|--------|---|-------------------|-------------------|------------------|--|--|--|
|  | <table border="1" style="width: 100%; border-collapse: collapse;"> <thead> <tr> <th>CAT #</th> <th>GANG(S)</th> <th>A</th> <th>B</th> <th>C</th> </tr> </thead> <tbody> <tr> <td style="text-align: center;">2347</td> <td style="text-align: center;">1</td> <td style="text-align: center;">4 3/4"<br/>(121mm)</td> <td style="text-align: center;">3"<br/>(76mm)</td> <td style="text-align: center;">1 3/8"<br/>(35mm)</td> </tr> <tr> <td style="text-align: center;">2347-2</td> <td style="text-align: center;">2</td> <td style="text-align: center;">4 3/4"<br/>(121mm)</td> <td style="text-align: center;">4 7/8"<br/>(124mm)</td> <td style="text-align: center;">1 3/8"<br/>(35mm)</td> </tr> </tbody> </table> | CAT #             | GANG(S)           | A                | B | C | 2347 | 1 | 4 3/4"<br>(121mm) | 3"<br>(76mm) | 1 3/8"<br>(35mm) | 2347-2 | 2 | 4 3/4"<br>(121mm) | 4 7/8"<br>(124mm) | 1 3/8"<br>(35mm) |  |  |  |
| CAT #  | GANG(S)  | A                 | B                 | C                |   |   |      |   |                   |              |                  |        |   |                   |                   |                  |  |  |  |
| 2347   | 1  | 4 3/4"<br>(121mm) | 3"<br>(76mm)      | 1 3/8"<br>(35mm) |   |   |      |   |                   |              |                  |        |   |                   |                   |                  |  |  |  |
| 2347-2   | 2  | 4 3/4"<br>(121mm) | 4 7/8"<br>(124mm) | 1 3/8"<br>(35mm) |   |   |      |   |                   |              |                  |        |   |                   |                   |                  |  |  |  |

**NOTE:** No suffix denotes ivory finish. Add “-WH” suffix for white finish.  
 All single-gang bases have a rectangular knockout on the base.

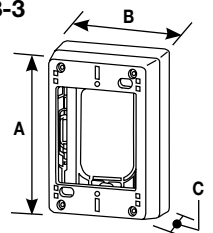
| Catalog No./Item   | Description/Specifications  |                   |                   |                  |   |   |      |   |                   |              |                  |        |   |                   |                   |                  |        |   |                   |               |                  |  |  |  |
|--|---|-------------------|-------------------|------------------|---|---|------|---|-------------------|--------------|------------------|--------|---|-------------------|-------------------|------------------|--------|---|-------------------|---------------|------------------|--|--|--|
| <b>2348</b><br><b>2348-2</b><br><b>2348-3</b>  | <b>Deep Device Box</b> – 2348 one-gang, 2348-2 two-gang, 2348-3 three-gang. For deeper switches and devices. 2348, 2348-2, and 2348-3 Bases have rectangular KO to enable extension from existing flush wall box and 1/2" and 1" concentric KOs. Accepts NEMA Faceplates.   |                   |                   |                  |   |   |      |   |                   |              |                  |        |   |                   |                   |                  |        |   |                   |               |                  |  |  |  |
|  | <table border="1" style="width: 100%; border-collapse: collapse;"> <thead> <tr> <th>CAT #</th> <th>GANG(S)</th> <th>A</th> <th>B</th> <th>C</th> </tr> </thead> <tbody> <tr> <td style="text-align: center;">2348</td> <td style="text-align: center;">1</td> <td style="text-align: center;">4 3/4"<br/>(121mm)</td> <td style="text-align: center;">3"<br/>(76mm)</td> <td style="text-align: center;">1 3/4"<br/>(35mm)</td> </tr> <tr> <td style="text-align: center;">2348-2</td> <td style="text-align: center;">2</td> <td style="text-align: center;">4 3/4"<br/>(121mm)</td> <td style="text-align: center;">4 7/8"<br/>(124mm)</td> <td style="text-align: center;">1 3/4"<br/>(44mm)</td> </tr> <tr> <td style="text-align: center;">2348-3</td> <td style="text-align: center;">3</td> <td style="text-align: center;">4 3/4"<br/>(121mm)</td> <td style="text-align: center;">7"<br/>(178mm)</td> <td style="text-align: center;">1 3/4"<br/>(44mm)</td> </tr> </tbody> </table> | CAT #             | GANG(S)           | A                | B | C | 2348 | 1 | 4 3/4"<br>(121mm) | 3"<br>(76mm) | 1 3/4"<br>(35mm) | 2348-2 | 2 | 4 3/4"<br>(121mm) | 4 7/8"<br>(124mm) | 1 3/4"<br>(44mm) | 2348-3 | 3 | 4 3/4"<br>(121mm) | 7"<br>(178mm) | 1 3/4"<br>(44mm) |  |  |  |
| CAT #  | GANG(S)   | A                 | B                 | C                |   |   |      |   |                   |              |                  |        |   |                   |                   |                  |        |   |                   |               |                  |  |  |  |
| 2348   | 1   | 4 3/4"<br>(121mm) | 3"<br>(76mm)      | 1 3/4"<br>(35mm) |   |   |      |   |                   |              |                  |        |   |                   |                   |                  |        |   |                   |               |                  |  |  |  |
| 2348-2   | 2   | 4 3/4"<br>(121mm) | 4 7/8"<br>(124mm) | 1 3/4"<br>(44mm) |   |   |      |   |                   |              |                  |        |   |                   |                   |                  |        |   |                   |               |                  |  |  |  |
| 2348-3   | 3   | 4 3/4"<br>(121mm) | 7"<br>(178mm)     | 1 3/4"<br>(44mm) |   |   |      |   |                   |              |                  |        |   |                   |                   |                  |        |   |                   |               |                  |  |  |  |

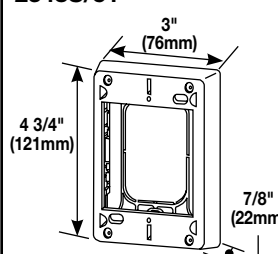
|   |   |  |  |  |
|---|---|--|--|--|
| <b>2348S/51</b>  | <b>Shallow Device Box / Extension Box</b> – For shallow switches and receptacles. Base has rectangular KO. Accepts NEMA Faceplates. |  |  |  |
|---|---|--|--|--|

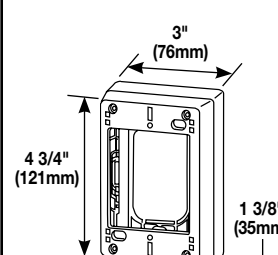
|   |  |  |  |  |
|---|--|--|--|--|
| <b>2348AMP</b>  | <b>Magnetic Deep Device Box (with Grommet)</b> – For deeper switches and devices. Magnetic backing. Base has rectangular KO. Accepts NEMA Faceplates |  |  |  |
|---|--|--|--|--|

### 400, 800, 2300 Series Raceway Round Fixture Boxes for Non-Divided Raceway Ordering Information

| Item  | Description         | Cat. No. | Diameter       | Depth     | Specifications  |
|---|---------------------|----------|----------------|-----------|---|
|  | Blank Cover         | 2336     | 4 1/2" (114mm) | —         | Use with any round nonmetallic device box to convert into junction box.   |
|  | Round Extension Box | 2337A    | 5 1/2" (140mm) | 1" (25mm) | For hanging fixtures, smoke/fire alarms and other security devices with 3 1/2" (89mm) or 4 1/16" (103mm) mounting centers. 5 1/2" (140mm) diameter with open base. Not for use with ceiling fans. |
|  | Fixture Box         | 2338A    | 5 1/2" (140mm) | 1" (25mm) | For hanging smoke/fire alarms and other security devices with 3 1/2" (89mm) or 4 1/16" (103mm) mounting centers. Not for use with ceiling fans.   |

**NOTE:** No suffix denotes ivory finish. Add “-WH” suffix for white finish.

## Sure-Snap® Device Boxes for 2300BACD Divided Series Raceway

The 2300BAC and 2300BACD Series Divided Raceway Box family provides two unique benefits; labor savings with “over-the-raceway” installation and Sure-Snap® device boxes. The 2348D and 2344D “over-the-raceway” design eliminates cutting the raceway base to mount boxes. The base snaps on anywhere along the raceway. The Sure-Snap integral device box of the 2344SD-2A combines aesthetics with labor savings. 5507 Series Faceplates, Pass & Seymour Activate Inserts, Wiremold Open System Communication Modules and Ortronics Series II and TracJack Modules snap directly into the Sure-Snap Device Box, eliminating the need for additional faceplates. The single-gang boxes accept standard NEMA faceplates.

### Sure-Snap® Device Boxes for 2300BACD Divided Series Raceway Ordering Information

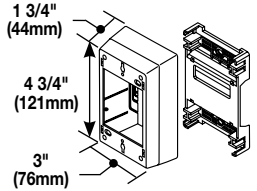
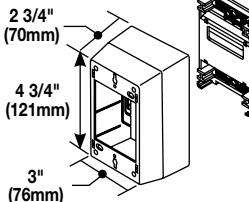
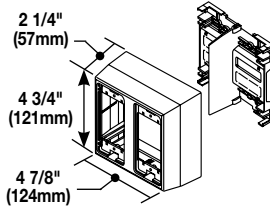
| Catalog No./Item  | Description/Specifications  |
|---|---|
| <p><b>2348D</b></p>  <p>1 3/4" (44mm)<br/>4 3/4" (121mm)<br/>3" (76mm)</p>           | <p><b>Device Box</b> – For use with 2300BACD Divided Raceway. For mounting standard switches, receptacles and industry standard faceplates for communication devices. Accepts NEMA Faceplates.</p>  |
| <p><b>2344D</b></p>  <p>2 3/4" (70mm)<br/>4 3/4" (121mm)<br/>3" (76mm)</p>           | <p><b>Extra Deep Device Box</b> – For use with 2300BACD Divided Raceway when additional depth is required. For mounting standard switches, receptacles and industry standard faceplates for communication devices. Accepts NEMA Faceplates.</p>   |
| <p><b>2344SD-2A</b></p>  <p>2 1/4" (57mm)<br/>4 3/4" (121mm)<br/>4 7/8" (124mm)</p> | <p><b>Two-Gang Deep Divided Box</b> – A divided two-gang box for use with 2300D Series Raceway. Provides the ability to have both power and low voltage at a single point of use. Accepts 5507 Series Faceplates, Ortronics® TracJack &amp; Series II Modules, Pass &amp; Seymour® Activate™ Series Inserts, and Wiremold Open System Communication Modules.</p> <p><b>Note:</b> Not for use with NEMA Faceplates. CM-EPLA End Plates are required when using Wiremold Open System communication modules and Pass &amp; Seymour® Activate inserts. S2-EPL End Plates are required when using Ortronics® Series II inserts. To mount Ortronics® TracJack modules, use 5507-4TJ or 5507-6TJ Faceplates.</p> |

#### 2344SD-2 Over-the-Raceway Box Application

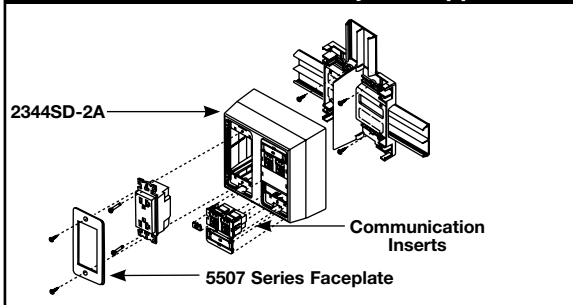

## 5507 Series Faceplates Ordering Information

| Catalog No./Item | Description/Specifications   | Catalog No./Item | Description/Specifications   |
|------------------|--|------------------|--|
| 5507AD           |  <p><b>Modular Furniture Adapter</b> – For mounting Activate modular furniture bezels and other modular furniture adapters. Not for use with rectangular (decorator) style devices.</p> | 5507RJ           |  <p><b>Dual RJ11/RJ45 Connector Faceplate</b> – For mounting one or two RJ type connectors – has one opening and a KO for the other.</p>   |
| 5507B            |  <p><b>Blank Faceplate</b> – For covering unused compartments in the device bracket.</p>  | 5507FRJ          |  <p><b>Flush Dual RJ11/RJ45 Connector Faceplate</b> – Same as 5507RJ except the connectors are recessed to provide a flush installation.</p>   |
| 5507D            |  <p><b>Duplex Receptacle Faceplate</b> – For covering duplex style devices. Accepts 106 Frame.</p>  | 5507-4TJ         |  <p><b>Ortronics® Faceplate</b> – For mounting Ortronics® datacom inserts. Accepts four TracJack Devices.</p>  |
| 5507R            |  <p><b>Rectangular Receptacle Faceplate</b> – For covering rectangular decorator style devices.</p>   | 5507-6TJ         |  <p><b>Ortronics® Faceplate</b> – For mounting Ortronics® datacom inserts. Accepts six TracJack Devices.</p>   |
| 5507S            |  <p><b>Rectangular Spacer</b> – For mounting commercial device plates. Installs between the device bracket and a device.</p>  | CM-EPLA          |  <p><b>End Plates</b> – Includes two outlet identification labels with clear covers and two matching screw covers. Required for mounting Pass &amp; Seymour® Activate™ and Wiremold Open System communication modules into the 2344SD-2A.</p> |
| 5507SW           |  <p><b>Switch Faceplate</b> – For covering standard toggle switches.</p>  | S2-EPL           |  <p><b>End Plates</b> – Includes two outlet identification labels with clear covers and two matching screw covers. Required for mounting Ortronics® Series II modules into the 2344SD-2A.</p>  |
| 5507T1           |  <p><b>Single Receptacle Faceplate</b> – For covering single receptacles – 1.59" (40mm) diameter.</p>   |                  |  |
| 5507T2           |  <p><b>Single Receptacle Faceplate</b> – For covering single receptacles – 1.41" (36mm) diameter.</p>   |                  |  |

**NOTE:** No suffix denotes ivory finish. Add “-WH” suffix for white finish, and “G” for Gray finish. Consult factory for custom colors.



**Electrical Wiring Systems**  
 60 Woodlawn Street  
 West Hartford, CT 06110  
 Phone: 1.877.BY.LEGRAND (295-3472)  
[www.legrand.us](http://www.legrand.us)  
 570 Applewood Crescent  
 Vaughan, Ontario L4K 4B4  
 Phone: 905.738.9195  
[www.legrand.ca](http://www.legrand.ca)

