



Industrial Specification Grade Plugs and Connectors

- 2 Pole, 3 Wire Grounding
- 3 Pole, 3 Wire Non-Grounding
- 4 Pole, 4 Wire Non-Grounding
- NEMA 5-15, 15A 125V
- NEMA 6-15, 15A 250V
- NEMA 5-20, 20A 125V
- NEMA 6-20, 20A 250V
- NEMA 7-20, 20A 277V
- NEMA 10-20, 20A 125/250V
- NEMA 18-20, 20A 120/280V 3Ø

Safety Grip™ Nylon Dead-Front Plugs and Connectors

FEATURES

- Nylon back-wired Dead-Front construction.
- Neoprene gasket seals cord hole opening.
- Dual range cord grip design.
- Combination head screws: U.S. Phillips/slotted; Can. Robertson/slotted.
- Add "-C" to catalog numbers for Canadian Screws.

Safety Grip™ Dead-Front Plugs and Connectors

| Rating | A | V/AC | NEMA | Description | Cord Diameter | Color | Catalog No. | |
|--------|-----------------|-------|----------|-------------|------------------------------|-------------------------------|---------------|-----------|
| | | | | | | | Plug | Connector |
| 15 | 125 | 5-15 | Straight | | 0.250-0.656" (6.4-16.7mm) | Black & White | 6266* | 6269* |
| | | | | | Angle | 0.300-0.656" (7.62-16.7mm) | Black & White | 6265* |
| 15 | 250 | 6-15 | Straight | | 0.250-0.656" (6.4-16.7mm) | Black & White | 6666* | 6669* |
| 20 | 125 | 5-20 | Straight | | 0.250-0.656" (6.4-16.7mm) | Black & White | 6766 | 6769† |
| 20 | 250 | 6-20 | Straight | | 0.250-0.656" (6.4-16.7mm) | Black & White | 6866 | 6869 |
| 20 | 277 | 7-20 | Straight | | 0.375-1.000" (9.5-25.4mm) | Black & White | 7624N | — |
| 20 | 125/250 | 10-20 | Straight | | 0.375-1.000" (9.5-25.4mm) | Black & White | 9151N† | — |
| 20 | 120/ 208V 3Ø | 18-20 | Straight | | 0.375-1.000" (9.5-25.4mm) | Black & White | 7251N† | — |

* Not Fed. Specs.

† Not CSA listed

INDUSTRIAL
COMMERCIAL
RESIDENTIAL

I-5 STRAIGHT BLADE PLUGS AND CONNECTORS

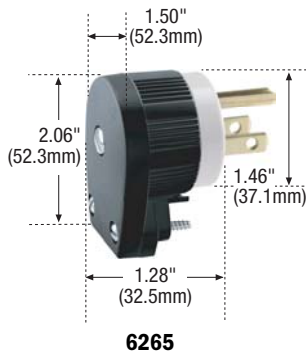

TESTING & CODE COMPLIANCE

- Listed to UL 498 (file no. E3663,)
- UL verified to Federal Spec. WC-596, except as noted.
- Listed to CSA, C22.2 no 42. (file no. LR7087), except as noted.

MATERIAL CHARACTERISTICS

Nylon.
Temperature Rating:
-40°C to 75°C.

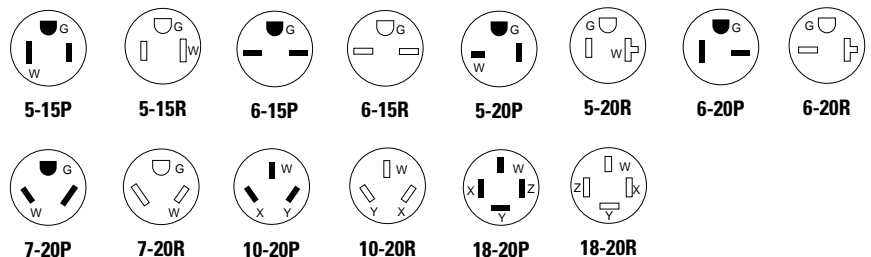

Industrial Specification Grade Plugs and Connectors

2 Pole, 3 Wire Grounding
 3 Pole, 4 Wire Grounding
 NEMA 5-15, 15A 125V
 NEMA 6-15, 15A 250V
 NEMA 5-20, 20A 125V
 NEMA 6-20, 20A 250V
 NEMA 14-20, 20A 125/250V,
 NEMA 15-20, 20A 250V 3Ø



AutoGrip™ Nylon Dead-Front Plugs and Connectors

FEATURES

- Neoprene gasket seals cord hole opening.
- Back wired Dead-Front design.
- All nylon construction reduces breakage and provides excellent chemical resistance.
- Automatic cord grip clamps the cord during assembly.
- Combination head screws: U.S. Phillips/slotted; Can. Robertson/slotted.
- Add "-C" to catalog numbers for Canadian Screws.

AutoGrip™ Dead-Front Plugs and Connectors

| Rating | | NEMA | Description | Cord Diameter | Color | Catalog No. | |
|--------|-------------|-------|------------------------------|-------------------------------|---------------|-------------|-----------|
| A | V/AC | | | | | Plug | Connector |
| 15 | 125 | 5-15 | Straight | 0.250-0.656" (6.4-16.7mm) | Black & White | 5266N | 5269N |
| | | | Straight Corrosion Resistant | 0.250-0.656" (6.4-16.7mm) | Yellow | 5266NCR | 5269NCR |
| | | | Straight Isolated Ground | 0.250-0.656" (6.4-16.7mm) | Orange | IG5266N | |
| 15 | 250 | 6-15 | Straight | 0.250-0.656" (6.4-16.7mm) | Black & White | 5666N | 5669N |
| 20 | 125 | 5-20 | Straight | 0.250-0.656" (6.4-16.7mm) | Black & White | 5366N | 5369N* |
| | | | Straight Corrosion Resistant | 0.250-0.656" (6.4-16.7mm) | Yellow | 5366NCR | 5369NCR* |
| | | | Straight | 0.250-0.656" (6.4-16.7mm) | Yellow | 5366NY | 5369NY* |
| 20 | 250 | 6-20 | Straight | 0.250-0.656" (6.4-16.7mm) | Black & White | 5466N | 5469N* |
| 20 | 125/ 250 | 14-20 | Straight | 0.625-1.125" (15.9-28.6mm) | Yellow | 5757*† | |
| 20 | 250V 3Ø | 15-20 | Straight | 0.625-1.125" (15.9-28.6mm) | Yellow | 5783*† | |

*Not CSA listed
 †Not Federal Spec.



5-15P



5-15R



6-15P



6-15R



5-20P



5-20R



6-20P



6-20R



14-20P



14-20R



15-20P



15-20R



5266N



5269N

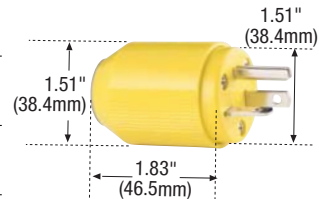

5366NCR

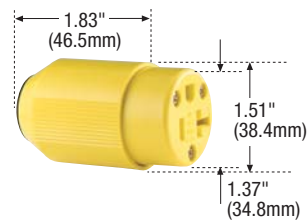

5369NCR

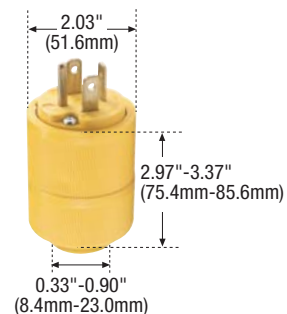

5757

INDUSTRIAL
 COMMERCIAL
 RESIDENTIAL

I-6 STRAIGHT BLADE PLUGS AND CONNECTORS

TESTING & CODE COMPLIANCE

- Listed to UL 498 (file no. E3663).
- Federal Spec. WC-596, except 5757 & 5783: (file no. E146159).
- CSA listed to C22.2 no 42. (file no. LR7087.)

MATERIAL CHARACTERISTICS

Nylon, except 5757 & 5783: ABS/PVC.
 Temperature Rating: -40°C to 75°C.



Industrial Specification Grade Plugs and Connectors

2 Pole, 3 Wire Grounding
 3 Pole, 3 Wire Non-Grounding
 NEMA 5-15, 15A 125V
 NEMA 5-20, 20A 125V
 NEMA 6-15, 15A 250V,
 NEMA 6-20, 20A 250V
 NEMA 10-20, 20A 125/250V

INDUSTRIAL
 COMMERCIAL
 RESIDENTIAL

I-7 STRAIGHT BLADE PLUGS AND CONNECTORS



5266

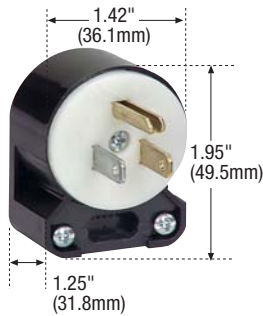

5266AN



5269

TESTING & CODE COMPLIANCE

- Listed to UL 498 (file no. E3663).
- UL verified to Federal Spec. WC-596 except as noted.
- CSA Certified to C22.2 no. 42. (file no. 2081 (6221-02)),
- NOM Certified.

MATERIAL CHARACTERISTICS

Polycarbonate and PVC.
 Environmental:
 Meets flammability requirements per UL 94, V2 rated.
 Temperature Rating:
 -40°C to 75°C.

Industrial Specification Grade Polycarbonate Plugs and Connectors

FEATURES

- High impact-resistant thermoplastic housings with easy-grip grooves.
- Assembly screws are speed-threaded and captive, reducing installation time.
- Solid brass plug blades are firmly embedded in body.
- See-through terminal cover allows inspection of connections.
- Terminals in individual chambers to positively insulate conductors.
- Clearly marked rating, NEMA configuration and standard compliances (third-party listing) on face of device.
- Terminal screws backed out - ready for wiring.
- Angle plugs have eight possible positions for maximum convenience.
- Combination slot/Phillips head mounting and terminal screws ease installation with power screwdrivers. (Slot/Robertson screws in Canada where available).

Industrial Specification Grade Polycarbonate Plugs and Connectors

| Rating | | | | Cord | | Catalog No. | |
|--------|---------|-------|-------------|-----------------------------|---------------|-------------|-----------|
| A | V/AC | NEMA | Description | Diameter | Color | Plug | Connector |
| 15 | 125 | 5-15 | Straight | 0.25 -0.69" (6.4-17.5mm) | Black & White | 5266 | 5269** |
| | | | Angle | 0.25 -0.69" (6.4-17.5mm) | Black & White | 5266AN** | |
| 20 | 125 | 5-20 | Straight | 0.25 -0.69" (6.4-17.5mm) | Black & White | 5366 | 5369** |
| | | | Angle | 0.25 -0.69" (6.4-17.5mm) | Black & White | 5366AN | |
| 15 | 250 | 6-15 | Straight | 0.25 -0.69" (6.4-17.5mm) | Black & White | 5666 | 5669** |
| | | | Angle | 0.25 -0.69" (6.4-17.5mm) | Black & White | 5666AN | |
| 20 | 250 | 6-20 | Straight | 0.25 -0.69" (6.4-17.5mm) | Black & White | 5466 | 5469** |
| | | | Angle | 0.25 -0.69" (6.4-17.5mm) | Black & White | 5466AN | |
| 20 | 125/250 | 10-20 | Straight | 0.25 -0.69" (6.4-17.5mm) | Black & White | 5236 | |

** Not Fed. Specs.

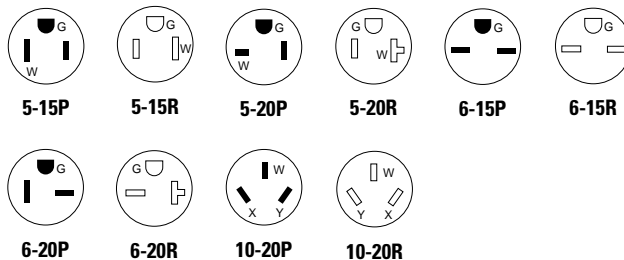

Industrial Specification Grade Plugs and Connectors

2 Pole, 3 Wire Grounding
 NEMA 5-15, 15A 125V
 NEMA 6-15, 15A 250V,
 NEMA 5-20, 20A 125V
 NEMA 6-20, 20A 250V



Quickeze™ Nylon Dead-Front Plugs

FEATURES

- Nylon backed-wired Dead-Front construction.
- Twist on cover eliminates assembly screws.
- All terminal screws located on same side for fast wiring.
- Automatic cord grip clamps the cord during assembly.
- Combination head screws: U.S. Phillips/slotted; Can. Robertson/slotted.
- Add "-C" to catalog numbers for Canadian Screws.

Quickeze™ Dead-Front Plugs

| Rating A | V/AC | NEMA | Description | Cord Diameter | Color | Catalog No. Plug |
|----------|------|------|------------------------------|------------------------------|--------|------------------|
| 15 | 125 | 5-15 | Straight | 0.250-0.656" (6.4-16.7mm) | Gray | 5965V |
| | | | Straight Corrosion Resistant | 0.250-0.656" (6.4-16.7mm) | Yellow | 5965VCR |
| 15 | 250 | 6-15 | Straight | 0.250-0.656" (6.4-16.7mm) | Gray | 5666V |
| 20 | 125 | 5-20 | Straight | 0.250-0.656" (6.4-16.7mm) | Gray | 5364V |
| | | | Straight Corrosion Resistant | 0.250-0.656" (6.4-16.7mm) | Yellow | 5364VCR |
| 20 | 250 | 6-20 | Straight | 0.250-0.656" (6.4-16.7mm) | Gray | 5464V |

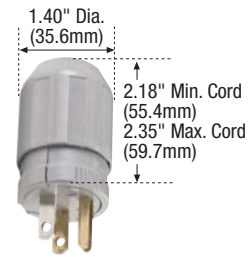

5965V

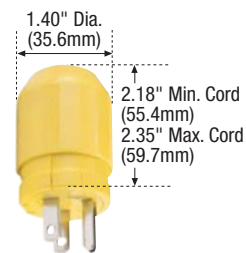

5965VCR

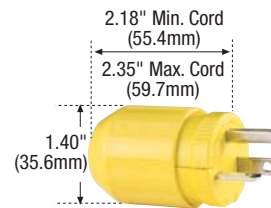

5364VCR

INDUSTRIAL
 COMMERCIAL
 RESIDENTIAL

I-8 STRAIGHT BLADE PLUGS AND CONNECTORS

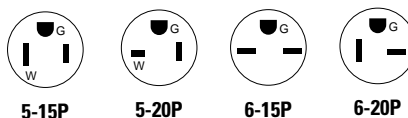

TESTING & CODE COMPLIANCE

- Listed to UL 498 (file no. E3663).
- Listed to CSA, C22.2 no. 42. (file no. LR7087).

MATERIAL CHARACTERISTICS

Nylon.
 Temperature Rating:
 -40°C to 95°C.



Industrial Specification Grade Plugs and Connectors

2 Pole, 3 Wire Grounding
 3 Pole, 3 Wire Non-Grounding
 NEMA 5-15, 15A 125V
 NEMA 6-15, 15A 250V,
 NEMA 5-20, 20A 125V
 NEMA 6-20, 20A 250V
 Non-NEMA 15/10A, 125/250V

INDUSTRIAL
 COMMERCIAL
 RESIDENTIAL

I-9 STRAIGHT BLADE PLUGS AND CONNECTORS

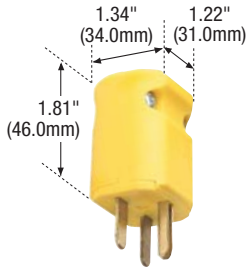

5666Y



5669Y

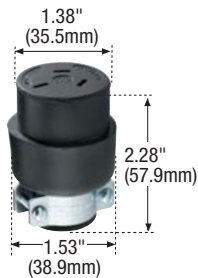

4472

TESTING & CODE COMPLIANCE

- Listed to UL 498 (file no. E146159).
- UL verified to Federal Spec. WC-596
- CSA certified to C22.2 no. 42, (file no. LR1765). (4475 and 4472 are not UL or CSA listed).

MATERIAL CHARACTERISTICS

Temperature Rating:
 -40°C to 75°C.

QuickGrip™ Dead-Front Plugs and Connectors

FEATURES

- One piece design and quick drive screws for fast wiring.
- High visibility yellow nylon for chemical and impact resistance.
- Combination head screws: Phillips/Robertson/slotted.
- UL verified to Federal Spec. WC-596F, CSA certified.

QuickGrip™ Dead-Front Plugs and Connectors

| Rating A | V/AC | NEMA | Description | Cord Diameter | Color | Catalog No. | |
|-------------|------|------|-------------|------------------------------|--------|-------------|-----------|
| | | | | | | Plug | Connector |
| 15 | 125 | 5-15 | Straight | 0.230-0.720" (5.8-18.3mm) | Yellow | 5965Y | 5969Y |
| | | | Straight | 0.230-0.720" (5.8-18.3mm) | Black | 5965BK | 5969BK |
| 15 | 250 | 6-15 | Straight | 0.230-0.720" (5.8-18.3mm) | Yellow | 5666Y | 5669Y |
| 20 | 125 | 5-20 | Straight | 0.230-0.720" (5.8-18.3mm) | Yellow | 5364Y | 5369Y |
| 20 | 250 | 6-20 | Straight | 0.230-0.720" (5.8-18.3mm) | Yellow | 5464Y | 5469Y |

Rubber Dead-Front Plugs

| Rating A | V/AC | NEMA | Description | Cord Diameter | Color | Catalog No. | |
|-------------|---------|----------|-------------|-------------------------------|-------|-------------|-----------|
| | | | | | | Plug | Connector |
| 15/10 | 125/250 | Non-NEMA | Straight | 0.560-.0650" (14.2-16.5mm) | Black | 4475** | |
| | | | | 0.325-0.560" (8.3-14.2mm) | Black | | 4472** |

** Not Fed. Specs.

