

# Commercial Specification Grade Plugs and Connectors

2 Pole, 3 Wire Grounding  
NEMA 5-15, 15A 125V  
NEMA 6-15, 15A 250V  
NEMA 5-20, 20A 125V  
NEMA 6-20, 20A 250V



## Thermoplastic Plugs and Connectors

### FEATURES

- Solid brass plug blades are firmly embedded in body.
- Terminal screw clamps are designed to contain wire and prevent binding.
- Terminal screws backed out – ready for wiring.
- Terminals in individual chambers to positively insulate conductors.
- Vinyl angle plugs have eight possible positions for maximum convenience.
- Combination slot/Phillips head mounting and terminal screws ease installation with power screwdrivers. (Slot/Robertson screws in Canada where available).

### Vinyl Plugs and Connectors

Rating		NEMA	Description	Cord Diameter	Color	Catalog No.	
A	V/AC					Plug	Connector
15	125	5-15	Straight	0.25"-0.655" (6.35mm-16.64mm)	Yellow	4867	4887
			Angle	0.25"-0.655" (6.35mm-16.64mm)	Yellow	4867AN	
				0.25"-0.655" (6.35mm-16.64mm)	White	4867ANW	
20	125	5-20	Straight	0.25"-0.655" (6.35mm-16.64mm)	Yellow	4409	4228
			Angle	0.25"-0.655" (6.35mm-16.64mm)	Yellow	4409AN	
15	250	6-15	Straight	0.25"-0.655" (6.35mm-16.64mm)	Yellow	4866	4227
			Angle	0.25"-0.655" (6.35mm-16.64mm)	Yellow	4866AN	
20	250	6-20	Straight	0.25"-0.655" (6.35mm-16.64mm)	Yellow	4509	4229
			Angle	0.25"-0.655" (6.35mm-16.64mm)	Yellow	4509AN	

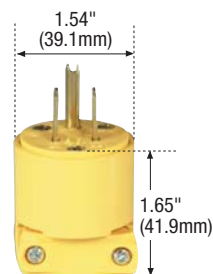

4867

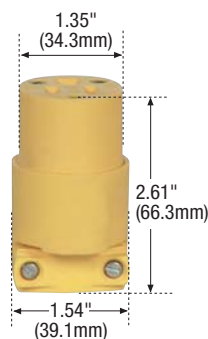

4887

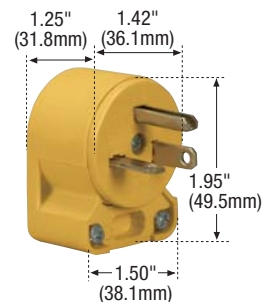

4409AN

INDUSTRIAL  
COMMERCIAL  
RESIDENTIAL

## I-14 STRAIGHT BLADE PLUGS AND CONNECTORS

### TESTING & CODE COMPLIANCE

- Listed UL 498 (file no. E15012).
- CSA Certified to C22.2 no. 42 (file no. LR2081 (6221-02)).
- NOM Certified.

### MATERIAL CHARACTERISTICS

Polypropylene and PVC.  
Environmental:  
Meets flammability requirements per UL 94, VO rated.  
Temperature Rating:  
-20°C to 60°C.



5-15P



5-15R



5-20P



5-20R



6-15P



6-15R



6-20P



6-20R



# Commercial Specification Grade Plugs and Connectors

2 Pole, 3 Wire Grounding  
 NEMA 5-15, 15A 125V  
 NEMA 6-15, 15A 250V  
 NEMA 5-20, 20A 125V  
 NEMA 6-20, 20A 250V

INDUSTRIAL  
 COMMERCIAL  
 RESIDENTIAL

## I-15 STRAIGHT BLADE PLUGS AND CONNECTORS

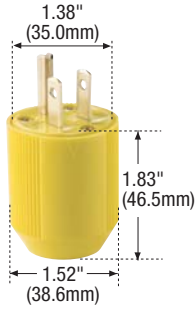

3867-3



3487-3

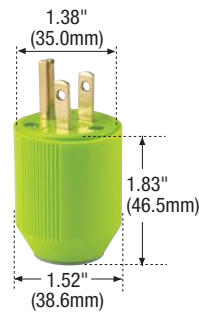

3867-4GN

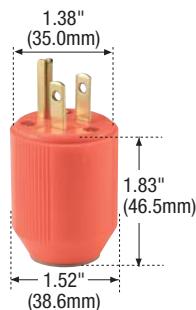

3867-4RN

### TESTING & CODE COMPLIANCE

- Listed to UL 498 (file no. E15012).
- CSA Certified C22.2 no. 42 (file no. 2081 (6221-02)).
- NOM Certified.

### MATERIAL CHARACTERISTICS

Nylon.  
 Temperature Rating:  
 -40°C to 75°C.

### Nylon Plugs and Connectors

#### FEATURES

- Solid brass plug blades are firmly embedded in body.
- Terminal screw clamps are designed to contain wire and prevent binding.
- Terminal screws backed out - ready for wiring.
- High visibility product available in three colors for quick location and identification of plugs in the middle of a job site.
- High visibility product contains neoprene dust cover which prevents dust from entering the plug or connector at the cable entrance.
- Combination slot/Phillips head mounting and terminal screws ease installation with power screwdrivers. (Slot/Robertson screws in Canada where available).

### High Visibility Plugs and Connectors

Rating A	V/AC	NEMA	Description	Cord Diameter	Color	Catalog No.	
						Plug	Connector
15	125	5-15	Straight	0.25"-0.656" (6.35mm-16.66mm)	Fluorescent Green	3867-4GN	3487-4GN
			Straight	0.25"-0.656" (6.35mm-16.66mm)	Fluorescent Orange	3867-4RN	3487-4RN
			Straight	0.25"-0.656" (6.35mm-16.66mm)	Bright Yellow	3867-4Y	3487-4Y

### Nylon Plugs and Connectors

Rating A	V/AC	NEMA	Description	Cord Diameter	Color	Catalog No.	
						Plug	Connector
15	125	5-15	Straight	0.25"-0.656" (6.35mm-16.66mm)	Yellow	3867-3	3487-3
						3829-3	3428-3
20	125	5-20	Straight	0.25"-0.656" (6.35mm-16.66mm)	Yellow	3866-3	3427-3
						4809-3	3429-3



5-15P



5-15R



5-20P



5-20R



6-15P



6-15R



6-20P



6-20R

# Commercial Specification Grade Plugs and Connectors

2 Pole, 3 Wire Grounding  
 NEMA 5-15, 15A 125V  
 NEMA 6-15, 15A 250V  
 NEMA 5-20, 20A 125V  
 NEMA 6-20, 20A 250V  
 NEMA 7-15, 15A 277V



## Vinyl Armored and Rubber Plugs

### FEATURES

- Solid brass plug blades are firmly embedded in body.
- Terminal screw clamps are designed to contain wire and prevent binding.
- Terminal screws backed out - ready for wiring.
- Terminals in individual chambers to positively insulate conductors.
- Armored housing automatically grounded.
- Combination slot/Phillips head mounting and terminal screws ease installation with power screwdrivers. (Slot/Robertson screws in Canada where available).

### Vinyl Armored Plugs

Rating	Cord		Catalog No.				
A	V/AC	NEMA	Description	Diameter	Color	Plug	Connector
15	125	5-15	Straight	0.25-0.625" (6.35-15.87mm)	Yellow	2867	2887
20	125	5-20	Straight	0.25-0.625" (6.35-15.87mm)	Yellow	2809	2228
15	250	6-15	Straight	0.25-.0625" (6.35-15.87mm)	Yellow	2866	2227
20	250	6-20	Straight	0.25-0.625" (6.35-15.87mm)	Yellow	3809	2229
15	277	7-15	Straight	0.25-0.625" (6.35-15.87mm)	Yellow	2839*	—

\*Not NOM

### Thermoplastic Rubber Plugs

Rating	Cord		Catalog No.				
A	V/AC	NEMA	Description	Diameter	Color	Plug	Connector
15	125	5-15	Straight	0.25-0.60" (6.35-15.24mm)	Black	1709	222*
15	250	6-15	Straight	0.25-0.60" (6.35-15.24mm)	Black	1711	229†
20	250	6-20	Straight	0.25-0.60" (6.35-15.24mm)	Black	1703	—

\* Not NOM  
 † Not NOM or CSA

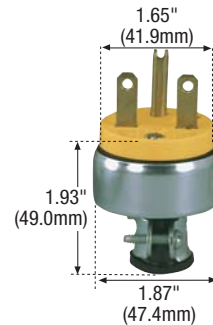
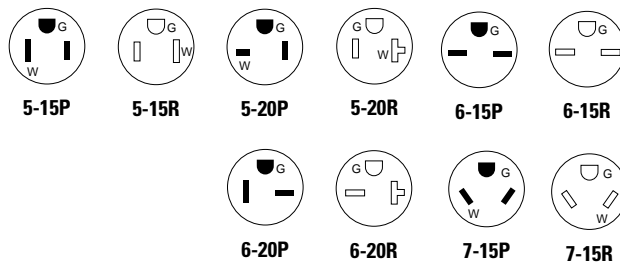

2866

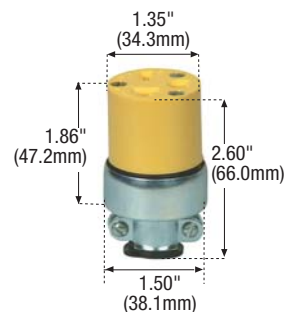

2229



1709



222

INDUSTRIAL  
 COMMERCIAL  
 RESIDENTIAL

## I-16 STRAIGHT BLADE PLUGS AND CONNECTORS

### TESTING & CODE COMPLIANCE

- Listed to UL 498 (file no. E15012).
- CSA Certified to C22.2 no. 42 (file no. 2081 (6221-02)).
- NOM Certified, except as noted.

### MATERIAL CHARACTERISTICS

PVC and Thermoplastic Rubber.  
 Environmental: Meets flammability requirements per UL 94, VO rated except 229.  
 Temperature Rating: -20°C to 60°C., except #229: -20°C to 70°C.



# Commercial Specification Grade Plugs and Connectors

2 Pole, 2 Wire Non-Grounding  
NEMA 1-15, 15A 125V

INDUSTRIAL  
COMMERCIAL  
RESIDENTIAL

## I-17 STRAIGHT BLADE PLUGS AND CONNECTORS

### TESTING & CODE COMPLIANCE

- Listed to UL 498 (file no. E15012).
- SA555C: CSA certified to C22.2 no. 42 (file no. 2081 (6221-02)).
- NOM Certified, except as noted.

### MATERIAL CHARACTERISTICS

Polypropylene, PVC and Thermoplastic Rubber.

Environmental:  
Meets flammability requirements per UL 94, VO rated except 224.  
Temperature Rating:  
-20°C to 60°C except 224:  
-20°C to 70°C.

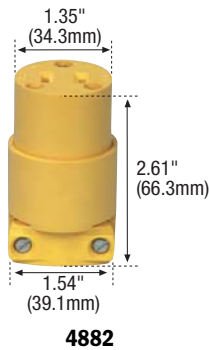
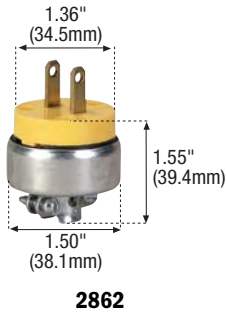
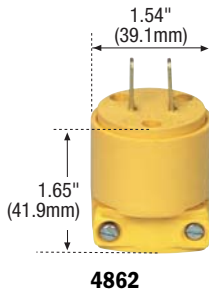

## Commercial Grade Plugs and Connectors

### FEATURES

- Solid brass plug blades are firmly embedded in body.
- Terminal screw clamps are designed to contain wire and prevent binding.
- Terminal screws backed out – ready for wiring.
- Terminals in individual chambers to positively insulate conductors.
- Vinyl angle plugs have eight possible positions for maximum convenience.
- Vinyl plugs and TPR rubber connectors resist chemical attack and stay flexible in extremely low temperatures.
- Armored housing automatically grounded.
- Combination slot/Phillips head mounting and terminal screws ease installation with power screwdrivers. (Slot/Robertson screws in Canada where available).

### Vinyl Plugs and Connectors

Rating A	V/AC	NEMA	Description	Cord Diameter	Color	Catalog No.	
						Plug	Connector
15	125	1-15	Straight	0.25-0.655" (6.35-16.637mm)	Yellow	4862	4882*
			Angle	0.25-0.655" (6.35-16.637mm)	White	4862ANW*	-

\*Not NOM

### Vinyl Armored Plugs and Connectors

Rating A	V/AC	NEMA	Description	Cord Diameter	Color	Catalog No.	
						Plug	Connector
15	125	1-15	Straight	0.25-0.625" (6.35-15.87mm)	Yellow	2862	2882*

\*Not NOM

### Rubber Plugs and Connectors

Rating A	V/AC	NEMA	Description	Cord Diameter	Color	Catalog No.	
						Plug	Connector
15	125	1-15	Straight	0.25-0.60" (6.35-15.24mm)	Black	1723	224*
			Straight Polarized	0.25-0.60" (6.35-15.24mm)			

\*Not NOM



# Standard Grade Plugs and Connectors

2 Pole, 3 Wire Grounding  
NEMA 5-15, 15A 125V



## Standard Grade Plugs and Connectors

### FEATURES

- Tough thermoplastic construction.
- Plug blades are firmly embedded in body.

### Thermoplastic Plugs and Connectors

Rating			Description	Cord Diameter	Color	Catalog No.	
A	V/AC	NEMA				Plug	Connector
15	125	5-15	Straight	0.67" (17.02mm)	Orange	6867	6887
			Straight	0.32" (8.13mm)	Black	SA399	SA993
			Straight	0.32" (8.13mm)	Brown	SA399B	SA993B
			Straight	0.32" (8.13mm)	Gray	SA399G	SA993G
			Straight	0.32" (8.13mm)	Green	SA399GN	SA933GN
			Straight	0.32" (8.13mm)	Orange	SA399O	SA993O
			Straight	0.32" (8.13mm)	White	SA399W	SA993W

### Rubber Plugs and Connectors

Rating			Description	Cord Diameter	Color	Catalog No.	
A	V/AC	NEMA				Plug	Connector
15	125	5-15	Straight Square	0.39" (9.91mm)	Black	142	-

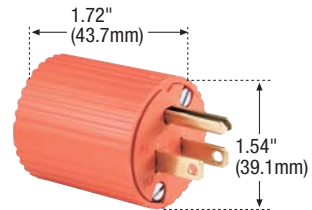

6867

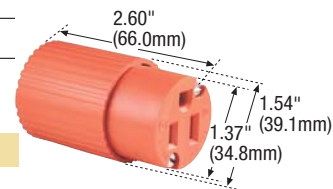

6887

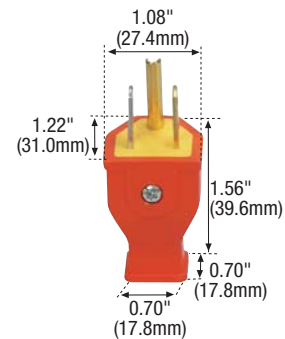

SA399

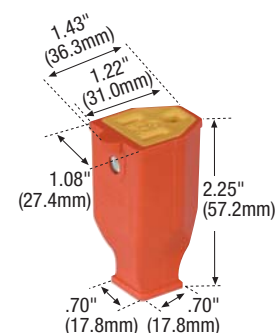

SA993



5-15P



5-15R

INDUSTRIAL  
COMMERCIAL  
RESIDENTIAL

## I-18 STRAIGHT BLADE PLUGS AND CONNECTORS

### TESTING & CODE COMPLIANCE

- Listed to UL 498 (file no. E15012).
- CSA Certified to C22.2 no. 42 (file no. LR2081 (file no. 2081 (6221-02, 6221-82))).

### MATERIAL CHARACTERISTICS

Polypropylene except 142: Rubber. Meets flammability requirements per UL 94, VO rated except 142. Temperature Rating: -20°C to 60°C except 142: -20°C to 70°C.



# Standard Grade Plugs and Connectors

2 Pole, 2 Wire Non-Grounding  
NEMA 1-15, 15A 125V

## Rubber Plugs and Connectors

### FEATURES

- Angle plugs allow placement of cord in convenient location.
- Plug blades are firmly embedded in body.
- Terminal screws backed out —ready for wiring.

INDUSTRIAL  
COMMERCIAL  
RESIDENTIAL

## I-19 STRAIGHT BLADE PLUGS AND CONNECTORS

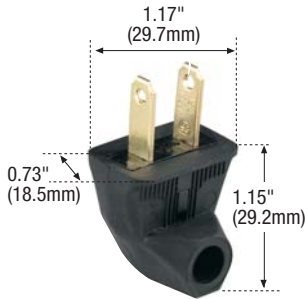

84



86



183

### Rubber Plugs and Connectors

Rating A	V/AC	NEMA	Description	Cord Diameter	Color	Catalog No.	
						Plug	Connector
15	125	1-15	Angle	0.328" (8.33mm)	Black	84BK	86BK
					White	84W	86W
15	125	1-15	Angle Polarized	0.328" (8.33mm)	Black	84-6BK	86BK
					White	84-6W	86W
15	125	1-15	Straight	0.328" (8.33mm)	Black	183BK	86BK
					White	183W	86W
15	125	1-15	Straight Polarized	0.328" (8.33mm)	Black	183-6BK	86BK
					White	183-6W	86W

### TESTING & CODE COMPLIANCE

- Listed to UL 498 (file no. E15012).
- Polarized plugs: CSA Certified to C22.2 no 42. (file no. LR2081 (6221-02, 6221-82)).
- NOM Certified.

### MATERIAL CHARACTERISTICS

Thermoplastic  
Rubber.  
Temperature Rating:  
-20°C to 70°C.



1-15P



1-15R

# Standard Grade Plugs and Connectors

2 Pole, 2 Wire  
NEMA 1-15, 15A 125V



INDUSTRIAL  
COMMERCIAL  
RESIDENTIAL

## I-20 STRAIGHT BLADE PLUGS AND CONNECTORS

### TESTING & CODE COMPLIANCE

- Listed to UL 498 (file no. E150120) except as noted.
- CSA certified to C22.2 no. 42 (file no. LR 2081 (6221-02, 6221-82)) except as noted.
- NOM Certified, except as noted.

### MATERIAL CHARACTERISTICS

Polypropylene and PVC except 1186: Urea. Meets flammability requirements per UL 94, VO rated, except 1186. Temperature Rating: -20°C to 60°C, except 1186: -40°C to 65°C.

## Thermoplastic Plugs

### FEATURES

- Plug blades are firmly embedded in body.
- Terminals in 6862/6882 have individual chambers to positively insulate conductors.

### Thermoplastic Plugs and Connectors

Rating		NEMA	Description	Cord Diameter	Color	Catalog No.	
A	V/AC					Plug	Connector
15	125	1-15	Flat Handle	0.312" (7.92mm)	Brown	1912B	-
				0.312" (7.92mm)	White	1912W	-
			Round	0.406" (10.31mm)	Black	3123BK	-
				0.437" (11.10mm)	Black	179*	-
				0.25-0.67" (1.59-17.02mm)	Orange	6862	6882

\* Not UL listed, or CSA certified.



1912

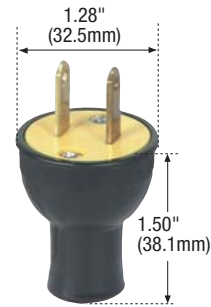

3123

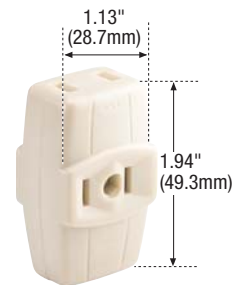

1186

## Triple Outlet Connector

### FEATURES

- Converts cord end into three two wire outlets.

### Triple Outlet Connector

Rating		NEMA	Description	Cord Size	Color	Catalog No.	
A	V/AC					Plug	Connector
15	125	1-15	Cord End	18-SPT	Brown	-	1186B*
			Triple Outlet		Ivory	-	1186V*

\* Not UL listed; not CSA certified; not NOM.



1-15P



1-15R

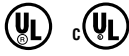

# Standard Grade Plugs and Connectors

2 Pole, 2 Wire  
NEMA 1-15, 15A 125V

## Spring Action Plugs and Connectors

### FEATURES

- Clip provides cord grip for easy storage on appliances such as vacuum cleaners, fans, etc.
- Made of high impact-resistant thermo-plastic for long-term durability.

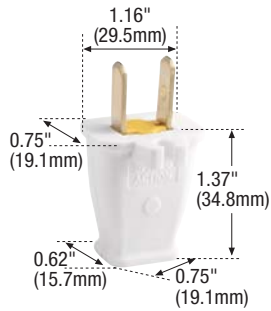

SA840

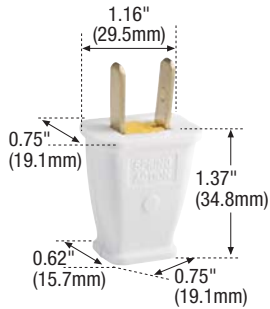

SA440W



SA540



SA940



SA155



1-15P



1-15R

### Thermoplastic Plugs and Connectors

Rating A	V/AC	NEMA	Description	Cord Diameter	Color	Catalog No.	
						Plug	Connector
15	125	1-15	Straight w/ Cord Clip	0.328" (8.33mm)	Black	SA840	SA155
					Brown	SA840B	SA155B
					White	SA840W	SA155W
15	125	1-15	Straight w/ Cord Clip Polarized	0.328" (8.33mm)	Black	SA940	SA155
					Brown	SA940B	SA155B
					White	SA940W	SA155W
15	125	1-15	Straight	0.328" (8.33mm)	Black	SA440	SA155
					Brown	SA440B	SA155B
					White	SA440W	SA155W
					Black	SA540	SA155
15	125	1-15	Straight Polarized	0.328" (8.33mm)	Brown	SA540B	SA155B
					Gold	SA540GD	SA155GD
					White	SA540W	SA155W

INDUSTRIAL  
COMMERCIAL  
RESIDENTIAL

## I-21 STRAIGHT BLADE PLUGS AND CONNECTORS

### TESTING & CODE COMPLIANCE

- Listed to UL 498 (file no. E15012), cUL listed to CSA C22.2 no. 42 (file no. E15012) except SA155: CSA Certified (file no. LR2081 (6221-02, 622182)).
- NOM Certified.

### MATERIAL CHARACTERISTICS

PVC and ABS.  
Meets flammability requirements per UL 94, VO rated.  
Temperature Rating: -20°C to 60°C.



# Standard Grade Plugs and Connectors

2 Pole, 2 Wire  
NEMA 1-15, 15A 125V



INDUSTRIAL  
COMMERCIAL  
RESIDENTIAL

## I-22 STRAIGHT BLADE PLUGS AND CONNECTORS

### Academy® Plugs

#### FEATURES

- High impact-resistant thermoplastic housing with finger-grip grooves.
- Super Plug™ has right angle design and built-in strain relief.
- Insulation piercing terminals eliminate need for tools – just snap in unstripped wire and device is ready for use.
- Plug blades are firmly embedded in body.

#### Super Plug™

Rating		NEMA	Description	Cord Size	Color	Catalog No.
A	V/AC					
15	125	1-15	Super Plug™	18-2 SPT-2,	Brown	2600B
				16-2 SPT-2,	Black	2600BK
				18-2 HPN, 16-2 HPN	White	2600W
15	125	1-15	Super Plug™ Polarized	18-2 SPT-2,	Brown	2600-6B
				16-2 SPT-2,	Black	2600-6BK
				18-2 HPN, 16-2 HPN	White	2600-6W

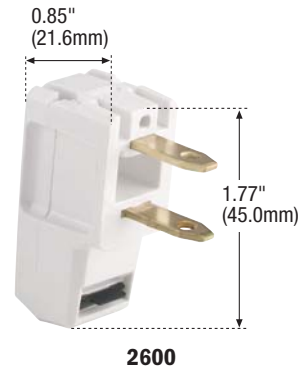

#### Easy Install Plug

Rating		NEMA	Description	Cord Size	Color	Catalog No.
A	V/AC					
10	125	1-15	Easy Install Plug	18-2 SPT-1	Brown	2601B
					Black	2601BK
					Clear	2601CL
					White	2601W
10	125	1-15	Easy Install Plug Polarized	18-2 SPT-1	Brown	2601-6B
					Black	2601-6BK
					Clear	2601-6CL
					White	2601-6W

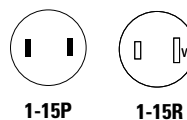
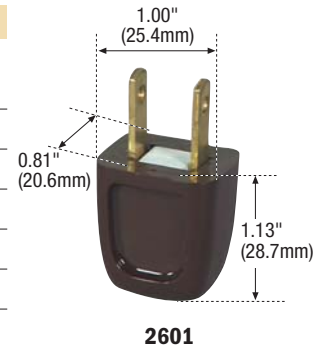

#### TESTING & CODE COMPLIANCE

- Listed to UL 498 (file no. E15012).
- CSA Certified to C22.2 no. 42 (file no. LR2081 (6221-02, 6221-82)).

#### MATERIAL CHARACTERISTICS

Polycarbonate.  
Meets flammability requirements per UL 94, V2 rated.  
Temperature Rating: -40°C to 70°C.



# Standard Grade Plugs and Connectors

2 Pole, 2 Wire  
NEMA 1-15, 15A 125V

INDUSTRIAL  
COMMERCIAL  
RESIDENTIAL

## I-23 STRAIGHT BLADE PLUGS AND CONNECTORS

### TESTING & CODE COMPLIANCE

- All 2607's are listed to UL 498 (file no. E15012).
- All 2607's are NOM Certified.

### MATERIAL CHARACTERISTICS

Polycarbonate.  
Meets flammability requirements per UL 94, V2 rated.  
Temperature Rating:  
-40°C to 70°C.

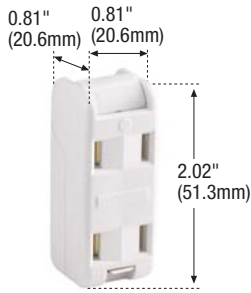

2602

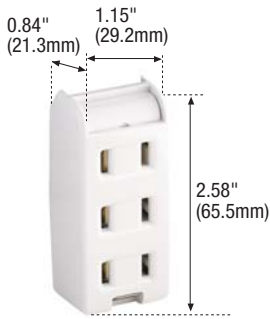

2603

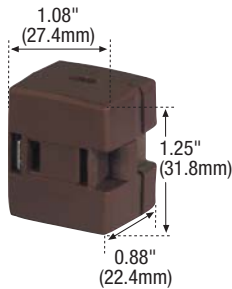

2606

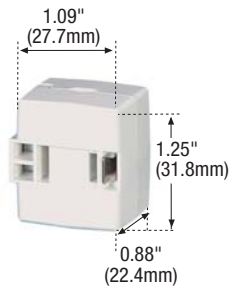

2607

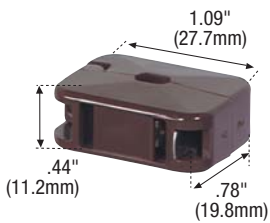

2609

### Academy® Outlets

#### FEATURES

- High impact-resistant thermoplastic housing virtually indestructible.
- Insulation piercing terminals eliminate need for tools – just snap in unstripped wire and device is ready for use.
- Outlets quickly add a receptacle to ordinary household wire.

#### Outlets

Rating	A	V/AC	NEMA	Description	Cord Size	Color	Catalog No.
10	125	1-15	Cord End Triple Outlet (Cube Tap)	18-2 SPT-1	Brown	2602B	
					White	2602W	
10	125	1-15	Cord End Triple Outlet (Table Tap)	18-2 SPT-1	Brown	2603B	
					White	2603W	
10	125	1-15	Cord End Outlet, Polarized	18-2 SPT-1,	Brown	2607B	
					18-2 SPT-2,	Black	2607BK
					18-2 HPN	White	2607W
10	125	1-15	In-Line Outlet, Polarized	18-2 SPT-1,	Brown	2606B	
					18-2 HPN	Black	2606BK
					White	2606W	
10	125	1-15	In-Line Outlet	18-2 SPT-1	Brown	2609B	
					Black	2609BK	
					White	2609W	



1-15P



1-15R