



Lightolier LyteCaster LED Downlights are ideal general purpose downlighting solution, providing comfortable, quality light. Available in new construction and remodeler frame with interchangeable light engine that is offered in two lumen packages. The downlight is wet location listed and comes in 3 standard option.

Project: _____
 Location: _____
 Cat.No: _____
 Type: _____
 Lamps: _____ Qty: _____
 Notes: _____

Complete product = Frame-in kit + Light engine + Trim Order each separately

Ordering guide: Frame-In kit

Example: L5RAEIVA

Series	Lumens ¹	Frame type	Dimming	Input voltage	Version
L5R	<input type="text"/>	<input type="text"/>	<input type="text"/>	<input type="text"/>	VA
L5R LyteCaster 5" Round	blank 1000 15 1500	A AirSeal IC, New Construction, Screw AN AirSeal IC, New Construction, Nail	E ELV dimming Z10 0-10V	1 120V	VA Version A ²
	10 1000 15 1500	R AirSeal IC, Remodeler		U Universal	

Ordering guide: Light engine

Example: L5R10827VA

Series	Lumens ¹	CRI	CCT	Version
L5R	<input type="text"/>	<input type="text"/>	<input type="text"/>	VA
L5R LyteCaster 5" Round	10 1000 15 1500	8 80	27 2700K 30 3000K 35 3500K 40 4000K	VA Version A ²
			9 90	

Note: Lumen output is calculated based on 80 CRI and 3500K CCT. Please consult adjustment factors table on page 5 for other lumen outputs.

Ordering guide: Trim

Example: L5RDW

Series	Luminaire type	Finish
L5R	<input type="text"/>	<input type="text"/>
L5R LyteCaster 5" Round	D Open Downlight	D Clear diffuse (with white flange) W White (with white flange)
	B Baffle Downlight	W White (with white flange)

- When ordering a Frame-in kit and a Light engine, the lumen package code must match.
- Version A (VA) frames and light engines are not compatible with previous versions.

L5R LyteCaster LED 5"

Round Downlight

New construction frame-in kit

Bottom view

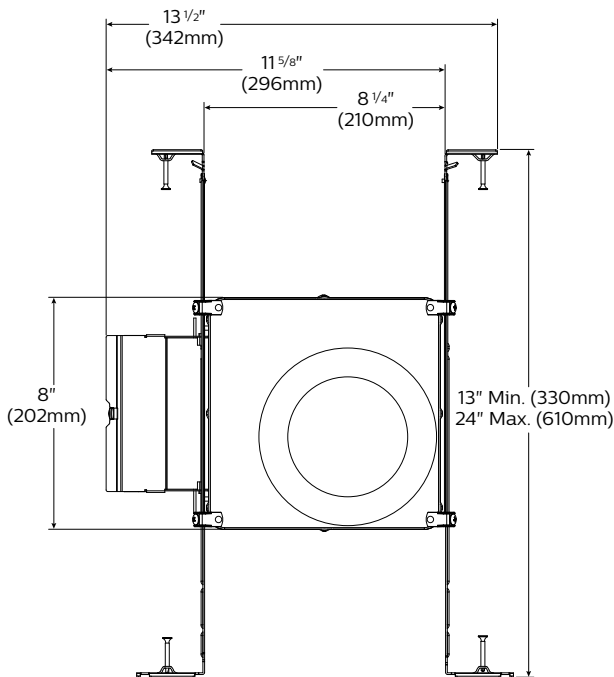

Side view

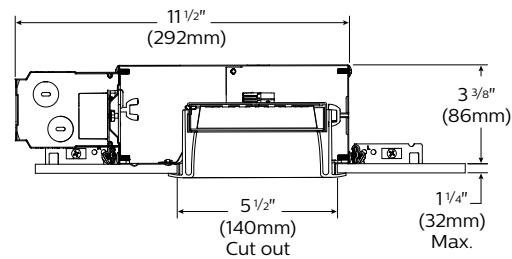

Downlight trim

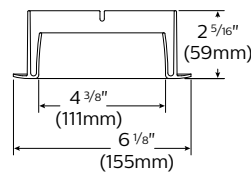

Light engine

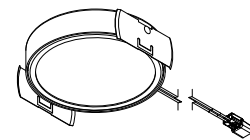

Features

- Housing:** .026" galvanized steel. UL listed for direct contact with thermal insulation. Airseal® housing minimizes air leakage to less than 2 CFM at 1.57PSF (or 75PA), which complies with the International Energy Conservation Code, and Washington State Energy Code (Section 502.4). This reduces heat loss and condensation in ceiling. Access door for inspection of junction box.
- Lower frame and top cover:** .026" galvanized steel. Accommodates ceilings up to 1 1/4" (32mm) thick. 3/8" (9.5mm) deep integral lip with four notches at 90° apart to simplify alignment. Locks into position along length of mounting bars with locking screws.
- Junction Box:** 2.5" X 5 3/8" X 2" (27 cu. in) .032" galvanized steel. UL listed 90° supply conductors. Rated for branch circuit wiring supplying connected luminaires (daisy chaining).
- Retaining clips:** Permit easy and fast installation of light engine/trim.
- Mounting bars:** .059" galvanized steel. Bars pivot for easy attachment and wire-in below ceiling line. Bars extend to accommodate 16" (406mm) to 24" (610mm) O.C. joist spacing. Bars can accommodate 12" (305mm) O.C. joist spacing after a slight field modification (see Instruction sheet). Features integral self tapping phillips/square drive screws for secure attachment to wood or metal construction. Also available with integral nails. Attaches to T-bar ceilings without the need of accessories. Bars installed on shortest dimension of frame, but can be easily repositioned 90 degrees from original position.
- Driver: ELV:** 120V, 50/60Hz. RoHS compliant, Class 2 power supply. Complies with FCC rules per Title 47 Part 15 (Class B) for EMI / RFI (conducted & radiated). Class A sound rating.
0-10V: 120/277V, 50/60Hz. RoHS compliant, Class 2 power supply. Complies with FCC rules per Title 47 Part 15 (Class A) for EMI / RFI (conducted & radiated). Class A sound rating.
- Ceiling cutout:** 5 1/2" (140mm).

Electrical

Lifetime: Expected lifetime 50,000 hours and backed by a 5-year warranty. (see Philips.com/warranties for details)

Recommended dimmers

See LED-DIM Specification Sheet.

Labels

cULus Listed Type I.C., frames are suitable for damp location. Trims are cULus suitable for wet location (no shower lens unit required). Complies with Air Leakage. Energy Star certified.

L5R LyteCaster LED 5"

Round Downlight

Remodeler kit

Bottom view

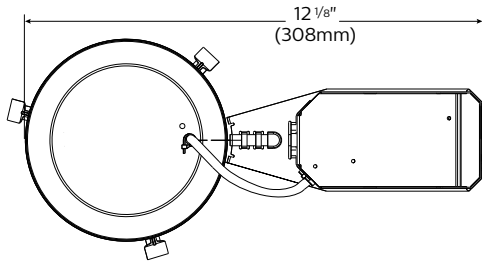

Side view

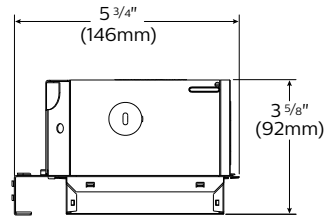

Side view

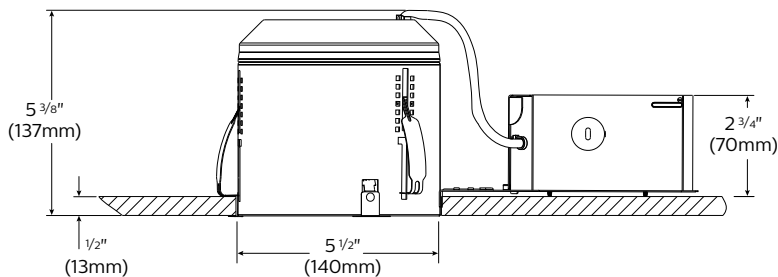

Features

- Housing:** .032 Aluminum. UL listed for direct contact with thermal insulation. Integral retaining spring secures housing to ceilings up to 2" thick. Removable for access to junction box and ceiling plenum. 5 1/2" maximum for use in 2" x 6" joist construction and shallow plenum applications. Airseal® housing minimizes air leakage to less than 2 CFM at 1.57PSF (or 75PA), which complies with the International Energy Conservation Code, and Washington State Energy Code (Section 502.4). This reduces heat loss and condensation in ceiling.
- Junction Box:** 2 1/2" x 2 1/2" x 4 7/8" (29 cu in.) .031" galvanized steel. UL listed for 90°C supply conductors. Rated for branch circuit wiring supplying connected fixtures.
- Retaining clips:** Permit easy and fast installation of light engine/trim.
- Driver: ELV / Triac:** 120V, 50/60Hz. RoHS compliant, Class 2 power supply. Complies with FCC rules per Title 47 Part 15 (Class B) for EMI/ RFI (conducted & radiated). Class A sound rating.
0-10V: 120/277V, 50/60Hz. RoHS compliant, Class 2 power supply. Complies with FCC rules per Title 47 Part 15 (Class A) for EMI/ RFI (conducted & radiated). Class A sound rating.
- Ceiling cutout:** 5 1/2" (140mm).

Electrical

Lifetime: Expected lifetime 50,000 hours and backed by a 5-year warranty. (see Philips.com/warranties or details)

Recommended dimmers

See LED-DIM Specification Sheet.

Labels

cULus Listed Type I.C., frames are suitable for damp location. Trims are cULus suitable for wet location (no shower lens unit required). Complies with Air Leakage. Energy Star certified.

L5R LyteCaster LED 5"

Round Downlight

Reflector: Round downlight

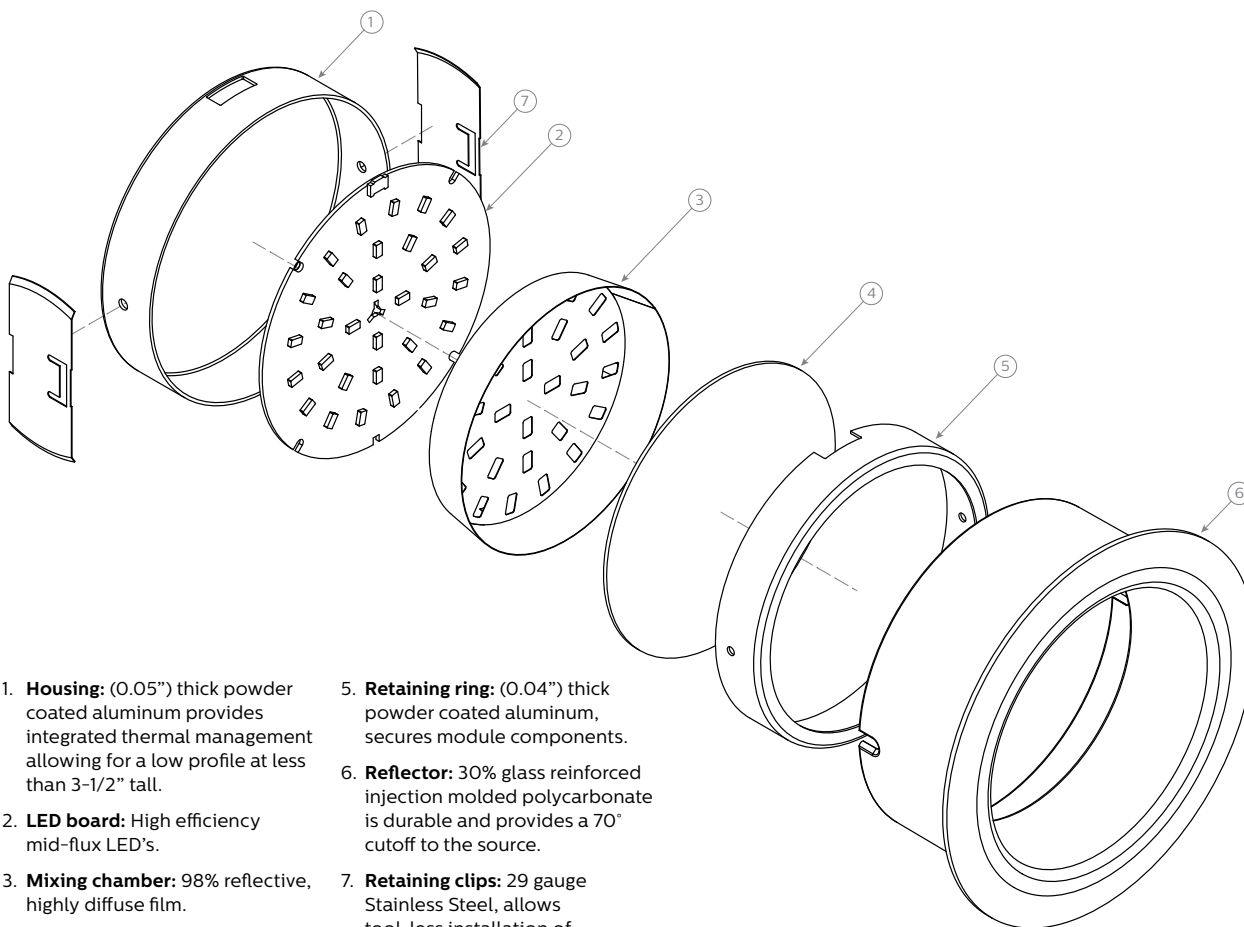

1. **Housing:** (0.05") thick powder coated aluminum provides integrated thermal management allowing for a low profile at less than 3-1/2" tall.
2. **LED board:** High efficiency mid-flux LED's.
3. **Mixing chamber:** 98% reflective, highly diffuse film.
4. **Diffusion lens:** (0.06") thick acrylic opal lens provides an even source of illumination.
5. **Retaining ring:** (0.04") thick powder coated aluminum, secures module components.
6. **Reflector:** 30% glass reinforced injection molded polycarbonate is durable and provides a 70° cutoff to the source.
7. **Retaining clips:** 29 gauge Stainless Steel, allows tool-less installation of light engine to trim.

Electrical specifications

Frame-in kit / Remodeler

	Lumens	Input volts	Input freq.	Input current	LED drive current	Input power	LED power	THD factor	Power factor
L5RAE1VA / L5R10RE1VA	1000	120V	50/60Hz	0.10A	260mA	12W	10W	<20%	>0.9
L5RAZ10UVA / L5R10RZ10UVA	1000	120V	50/60Hz	0.11A	260mA	13W	11W	<10%	>0.9
		277V	50/60Hz	0.06A	260mA	13W	11W	<15%	>0.9
L5R15AE1VA / L5R15RE1VA	1500	120V	50/60Hz	0.16A	375mA	15W	13W	<20%	>0.9
L5R15AZ10UVA / L5R15RZ10UVA	1500	120V	50/60Hz	0.26A	375mA	16W	13W	<10%	>0.95
		277V	50/60Hz	0.11A	375mA	16W	13W	<15%	>0.95

L5R LyteCaster LED 5"

Round Downlight

80 CRI, 1000 lumens

Candela Curves

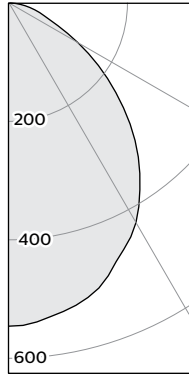

Angle	Mean CP	Lumens
0	546	51
5	541	
10	529	
15	515	145
20	490	
25	459	212
30	429	
35	385	241
40	340	
45	289	222
50	236	
55	184	165
60	135	
65	91	93
70	63	
75	45	48
80	28	
85	12	13
90	0	

Single unit data

Height to Lighted Plane	Initial Center Beam Foot-Candles	Beam Dia. (ft)*
5'	22	6.0'
6'	15	7.2'
7'	11	8.4'
8'	9	9.6'
9'	7	10.8'

* Beam diameter is where foot-candles drop to 50% of maximum.

Multiple unit data - RCR 2

Spacing on center	Initial Center Beam Foot-Candles	Watts per Sq. Ft.
5'	49.5	0.51
6'	32.5	0.34
7'	23.2	0.24
8'	19.3	0.20
9'	15.5	0.16

38'x38'x10' Room, Workplane 2.5' above floor, 80/50/20% Reflectances

Coefficients of utilization

Ceiling	80%				70%		50%		30%		0%	
Wall	70	50	30	10	50	10	50	10	50	10	0	
RCR	Zonal cavity method - Effective floor reflectance = 20%											
Room Cavity Ratio	0	119	119	119	119	116	116	111	111	106	106	100
	1	110	106	102	99	104	97	99	94	96	91	87
	2	101	94	88	83	92	82	89	80	85	78	74
	3	93	84	76	70	82	70	79	69	77	67	64
	4	86	75	67	61	74	60	71	60	69	59	56
	5	80	68	59	53	67	53	65	52	63	52	49
	6	74	61	53	47	60	47	59	47	57	46	44
	7	69	56	48	42	55	42	54	42	52	41	39
	8	64	51	43	38	51	38	49	38	48	37	35
	9	60	47	40	34	47	34	46	34	45	34	32
	10	56	44	36	31	43	31	42	31	41	31	29

Frame: L5RAE1VA / L5RAZ10UVA / L5R10RE1VA / L5R10RZ10UVA
 Light engine: L5R10835VA
 Trim: L5RDW Report no³: 685GFR

Output lumens: 1190lm
 Input Watts: 11.6W
 Spacing Criterion: 1.2
 Efficacy: 102.6lm/W
 CCT²: 3500K
 CRI: ≥80

Zonal lumens & percentages

Zone	Lumens	%Luminaire
0-30	408	34.3%
0-40	649	54.5%
0-60	1036	87.1%
0-90	1190	100.0%

CRI and CCT adjustment factors

90CRI 2700K: = 0.71
80CRI 2700K: = 0.89
80CRI 3000K: = 0.97
80CRI 3500K: = 1.00

80 CRI, 1500 lumens

Candela Curves

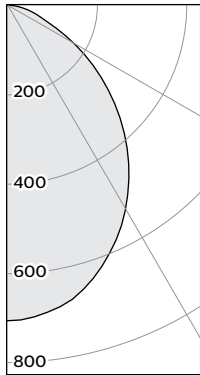

Angle	Mean CP	Lumens
0	703	66
5	697	
10	682	
15	656	185
20	619	
25	576	265
30	527	
35	474	296
40	417	
45	357	275
50	295	
55	234	209
60	175	
65	120	121
70	81	
75	57	60
80	35	
85	15	17
90	0	

Single unit data

Height to Lighted Plane	Initial Center Beam Foot-Candles	Beam Dia. (ft)*
5'	28	5.5'
6'	20	6.6'
7'	14	7.7'
8'	11	8.8'
9'	9	9.9'

* Beam diameter is where foot-candles drop to 50% of maximum.

Multiple unit data - RCR 2

Spacing on center	Initial Center Beam Foot-Candles	Watts per Sq. Ft.
5'	62.1	0.70
6'	40.8	0.46
7'	29.1	0.33
8'	24.3	0.27
9'	19.4	0.22

38'x38'x10' Room, Workplane 2.5' above floor, 80/50/20% Reflectances

Coefficients of utilization

Ceiling	80%				70%		50%		30%		0%	
Wall	70	50	30	10	50	10	50	10	50	10	0	
RCR	Zonal cavity method - Effective floor reflectance = 20%											
Room Cavity Ratio	0	119	119	119	119	116	116	111	111	106	106	100
	1	110	106	102	99	104	97	99	94	96	91	87
	2	101	94	88	83	92	82	89	80	85	78	74
	3	93	84	76	70	82	70	79	69	77	67	64
	4	86	75	67	61	74	60	71	60	69	59	56
	5	80	68	59	53	67	53	64	52	63	52	49
	6	74	61	53	47	60	47	59	46	57	46	44
	7	69	56	48	42	55	42	54	42	52	41	39
	8	64	51	43	38	51	38	49	38	48	37	35
	9	60	47	40	34	47	34	46	34	45	34	32
	10	56	44	36	31	43	31	42	31	42	31	29

Zonal lumens & percentages

Zone	Lumens	%Luminaire
0-30	516	34.5%
0-40	811	54.3%
0-60	1295	86.7%
0-90	1494	100.0%

CRI and CCT adjustment factors

90CRI 2700K: = 0.71
80CRI 2700K: = 0.89
80CRI 3000K: = 0.97
80CRI 3500K: = 1.00

1. Wattage: controlled to within ± 5%
2. Correlated Color Temperature: within specs as defined in ANSI_NEMA_ANSI C78.377-2008: Specifications for the Chromaticity of Solid State Lighting Products.
3. Tested using absolute photometry as specified in LM79: IESNA Approved Method for the Electrical and Photometric Measurements of Solid-State Lighting Products.

