

# Section

# F

New  
New

**Selection Guide..... F-2**

## **Din Rail Snap/Surface-Mount Sockets**

- SU Series .....F-6
- SJ Series .....F-9
- SQ Series ..... F-10
- SR Series ..... F-11
- SH Series ..... F-14
- SY Series ..... F-18
- SM Series..... F-20

## **Through Panel Mount Sockets**

- SR Series ..... F-21
- SH Series ..... F-22
- SY Series ..... F-24

## **PCB Mount Sockets**

- SH Series ..... F-25
- SY Series ..... F-26

## **Panel Mounted Sockets for Timers**

- SR Series ..... F-28

**Accessories..... F-29**

**Dimensions..... F-31**

Sockets

for more information on this product family visit

**[www.idec.com/socket](http://www.idec.com/socket)**

### **Additional Web Resources**

- New and updated product information
- Downloadable software demos & upgrades
- Part configuration tool & cross reference
- Online stock check & ordering
- IDEC field sales & distributor search
- Online literature request
- Downloadable manuals & CAD drawings
- Manufacturer's suggested retail price list
- Product training schedule & locations
- Advertising & trade show schedules
- Press releases & FAQs

[www.idec.com/socket](http://www.idec.com/socket)

**Relay and Timer Socket Selection Guide**

**Relay and Timer Socket**

Mounting	Series	Page	Part No.	No. of Poles	Receptacle	Terminal	Compatible IDEC Relay and Timer
<b>DIN Rail Snap/Surface-Mount</b> 	SU	F-6	SU2S-11L	2	8-Blade	Spring Clamp Terminals	RU2, RM2
			SU4S-11L	4	14-Blade		RU4, RU42, RY4, RY42
	SR	F-11	SR2P-05 SR2P-05C SR2P-06	2	8-Pin	M3.5 Screw	RR2P, GT5P, RTE-P1, GT3 (8-pin)
			SR3P-05 SR3P-05C SR3P-06	3	11-Pin		RR3PA, RR2KP, RTE-P2 GT3 (11-pin)
			SR3B-05	3	11-Blade		RR1BA, RR2BA, RR3B, RTE-B
	SH	F-14	SH1B-05 SH1B-05C	1	5-Blade	M3.5 Screw Coil Terminal: M3	RH1B
			SH2B-05 SH2B-05C	2	8-Blade		RH2B
			SH3B-05 SH3B-05C	3	11-Blade		RH3B, RH2LB
			SH4B-05 SH4B-05C	4	14-Blade		RH4B
	SY	F-18	SY2S-05 SY2S-05C	2	8-Blade	M3 Screw	RY2S, RY22S
			SY4S-05 SY4S-05C	4	14-Blade		RU4S, RU42S, RY4S, RY42S, RY2KS, RM2S, GT5Y
	SM	F-20	SM2S-05 SM2S-05C	2	8-Blade	M3 Screw	RU2S, RM2S
	SJ	F-9	SJ1S-05B SJ1S-07L	1	5-Blade	M3 Screw	RJ1S
			SJ2S-05B SJ2S-07L	2	8-Blade		RJ2S
SQ	F-10	SQ1V-07B	1	5-Blade	M3 Screw	RQ1V-CM	
		SQ2V-07B	2	8-Blade		RQ2V-CN RQ1V-CH	
<b>Through Panel Mount</b> 	SR	F-21	SR2P-51	2	8-Pin	Solder	RR2P, GT5P, RTE-P1, GT3 (8-pin)
			SR3P-51	3	11-Pin		RR3PA, RR2KP, RTE-P2, GT3 (11-pin)
			SR3B-51	3	11-Blade		RR1BA, RR2BA, RR3B
	SH	F-22	SH1B-51	1	5-Blade	Solder	RH1B
			SH2B-51	2	8-Blade		RH2B
			SH3B-51	3	11-Blade		RH3B, RH2LB
			SH4B-51	4	14-Blade		RH4B
	SY	F-24	SY2S-51	2	8-Blade	Solder	RY2S, RY22S
			SY4S-51	4	14-Blade		RY4S, RY42S, RU4S, RU42S, RY2KS, RM2S, GT5Y
	<b>PCB Mount</b> 	SH	F3-25	SH1B-62	1	5-Blade	PC Board
SH2B-62				2	8-Blade	RH2B	
SH3B-62				3	11-Blade	RH3B, RH2LB	
SH4B-62				4	14-Blade	RH4B	
SY		F3-26	SY2S-61	2	8-Blade	PC Board	RY2S, RY22S
			SY4S-61	4	14-Blade		RY4S, RY42S, RU4S, RU42S, RY2KS, RM2S, GT5Y
			SY4S-62	4	14-Blade		RY4S, RY42S, RU4S, RU42S, RY2KS, RM2S, GT5Y

**For Panel Mounted Timers**

	SR	F-28	SR6P-M08G	2	8-pin	M3.5 Screw	GE1A; RTE-P1; GT3 (8-pin);
			SR6P-M11G		11-pin		RTE-P2; GT3 (11-pin)



For relay mounting accessories, see page F-29.

**F**  
**Sockets**

## Specifications

### SU, SR, SH, SM, SY

<b>Specifications</b>	<b>Rated Insulation Voltage</b>	300V; except SH1B, SU and SY4S-62: 250V
	<b>Rated Current</b>	SU2/SR/SH/SM: 10A, SY: 7A, SU4: 6A with RU4, SU4: 10A with RU2 (SH1B: 7A)
	<b>Insulation Resistance</b>	100MΩ minimum
	<b>Dielectric Strength</b>	2,000V AC, 1 minute
	<b>Material Grade</b>	UL94V-0
	<b>Terminal Torque</b>	3.5mm Screws, 9-11.5 in•lbs 3mm screws, 5.5-9 in•lbs



1. \* Applicable to DIN rail sockets only.



File No. BL950813332307

### SJ, SQ

Specifications	SJ Series	SQ Series
<b>Rated Current</b>	SJ1S: 12A Max; SJ2S: 8A Max	SQ1V: 12A Max; SQ2V: 10A Max
<b>Rated Voltage</b>	250V	300V
<b>Applicable Wire</b>	2x #14 (2.5mm <sup>2</sup> )	2x #14 (2.5mm <sup>2</sup> )
<b>Applicable Crimping Terminal</b>	2mm <sup>2</sup> x 2	1.5mm <sup>2</sup> x 2
<b>Terminal Torque</b>	0.6 to 1.0Nm	1.0Nm Max
<b>Screw Size</b>	M3 Slotted Phillip Captive Screw	M3 Slotted Phillip Captive Screw
<b>Dielectric Strength (Coil/Contact)</b>	4,000VAC	3,000VAC
<b>Insulation Resistance</b>	≥100 MΩ Minimum	≥100 MΩ Minimum
<b>Operating Temperature</b>	-40 to 70°C (no freezing)	-25 to +85°C
<b>Operating Humidity</b>	5~85% RH (no condensation)	45~85% RH

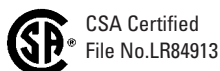

**Hold-Down Springs and Clips Selection Guide**

**DIN Rail Snap/Surface-Mount Sockets**

Socket Part No.	Applicable Relays, Timer	Hold-Down Pullover Spring	Hold-Down Clip (side latch)	Hold-Down Clip (top latch)
SU2S-11L SU4S-11L	RM2S, RU2, GT5Y-2	SY4S-51F1	SFA-202	SFA-101
	RY4S, RY42S, RU4, RU42, GT5Y, RY2KS, RM2S	SY4S-51F1	SFA-202	SFA-101
SR2P-05 SR2P-05C	RR2P	SR2B-02F1	SFA-203	—
	RTE-P1, GT3, GT5P	—	SFA-203	—
SR2P-06	RR2P	SR2B-02F1	SFA-202	—
	GT3 (8-pin), RTE-P1, GT5P	—	SFA-202	—
SR3P-05 SR3P-05C	RR3PA	SR3B-02F1	SFA-203	—
	RR2KP	SR3P-06F3	SFA-203	—
	RTE-P2, GT3 (11-pin)	—	SFA-203	—
SR3P-06	RR3PA	SR3B-02F1	SFA-202	—
	RR2KP	SR3P-06F3	SFA-202	—
	RTE-P2, GT3 (11-pin)	—	SFA-202	—
SR3B-05	RR1BA, RR2BA, RR3B, RTE-B	SR3B-02F1	SFA-202	—
SH1B-05 SH1B-05C	RH1B	SY2S-02F1	SFA-202	SFA-101
SH2B-05 SH2B-05C	RH2B	SY4S-02F1	SFA-202	SFA-101
SH3B-05 SH3B-05C	RH3B, RH2LB	SH3B-05F1	SFA-202	SFA-101
SH4B-05 SH4B-05C	RH4B	SH4B-02F1	SFA-202	SFA-101
SY2S-05 SY2S-05C	RY2S, RY22S	SY2S-02F1	SFA-202	SFA-101
SY4S-05 SY4S-05C	RY4S, RY42S, RU4, RU42, RM2S	SY4S-51F1	SFA-202	SFA-101
	RY2KS, GT5Y	(SY4S-51F3)	SFA-202	
SM2S	RM2S, RU2	SY4S-51F1	SFA-202	SFA-101
SJ1S SJ2S	RQ1S RJ2S	SJ9Z-C		
SQ1S SQ2S	RQ1V RQ2V	SQ9Z-C		

1. Hold-down springs work in conjunction with hold-down spring anchors included with DIN rail sockets.
2. When mounting relays with a check button onto panel mount or PC board mount sockets, use the hold-down spring shown in parenthesis. Hold-down springs for relays with check buttons are not available for SR2P-51.
3. For close mounting of panel mount or PC mount sockets, use hold-down clips rather than hold-down springs.
4. SFA-101, SFA-202 and SFA-302 come in pairs.

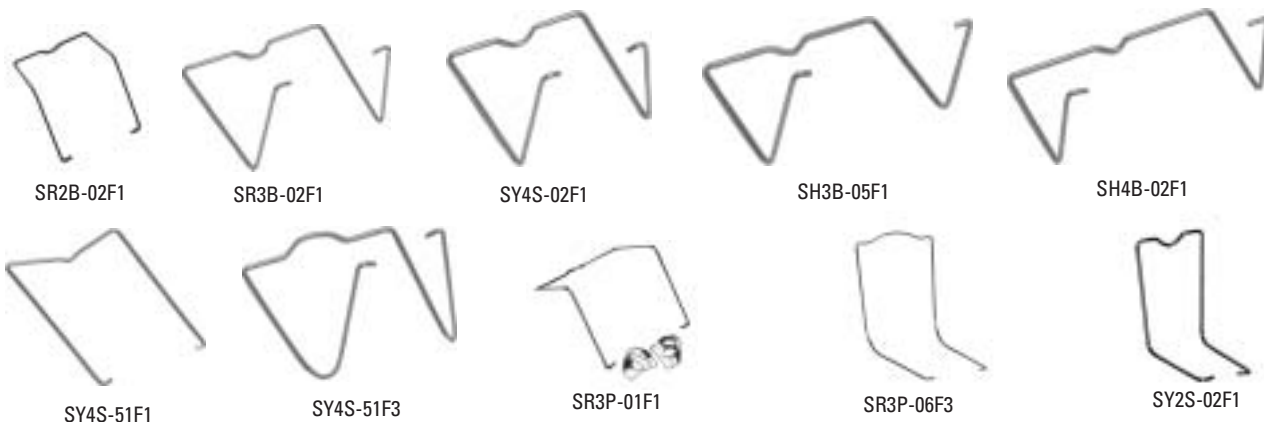

Sockets

## Panel and PC Board Mount Sockets

Socket Part No.	Applicable Relays, Timer	Hold-Down Pullover Spring	Hold-Down Clip (side latch)	Hold-Down Clip (top latch)
SR2P-51	RR2P	SR3P-01F1	—	—
	GT3 (8-pin), RTE-P1	—	SFA-402	—
SR3P-51	RR3PA	SR3P-01F1	—	—
	RR2KP	SR3P-51F3	—	—
	GT3 (11-pin), RTE-P2	—	SFA-402	—
SR3B-51	RR1BA, RR2BA, RR3B, RTE-B	SR3B-02F1	—	—
SH1B-51 SH1B-62	RH1B	SY4S-51F1	—	SFA-301 SFA-302
SH2B-51	RH2B	SY4S-51F1 (SY4S-02F1)	—	SFA-301 SFA-302
SH2B-62	RH2B	SY4S-51F1 (SY4S-02F1)	—	—
SH3B-51 SH3B-62	RH3B, RH2LB	SY4S-51F1 (SY4S-02F1)	—	SFA-301 SFA-302
SH4B-51 SH4B-62	RH4B	SY4S-51F1 (SH4B-02F1)	—	SFA-301 SFA-302
SY2S-51 SY2S-61	RY2S, RY22S	SY4S-51F1	—	SFA-301 SFA-302
SY4S-51 SY4S-61	RY4S, RY42S	SY4S-51F1 (SY4S-02F1)	—	SFA-301 SFA-302
	RY2KS	SY4S-51F1 (SY4S-02F3)	SFA-302	—
	GT5Y	—	SFA-302	—
SY4S-62 *	RY4S, RY42S, RM2S	SY4S-51F1 (SY4S-02F1)	—	—
	RY2KS	SY4S-51F1 (SY4S-02F3)	—	—

\* Does not accept hold down clips



SFA-101



SFA-202



SFA-302



SFA-301



SFA-203



SFA-402

**SU Series: DIN Rail Snap-Mount Sockets**



<b>SU2S-11L</b>	
<b>Style</b>	8-blade DIN-mount/surface mount
<b>Terminal</b>	Spring clamp terminals
<b>Wire Size</b>	24-16 AWG
<b>Electrical Rating</b>	10A
<b>Compatible Relay</b>	RU2, RM2
<b>Compatible Timer</b>	GT5Y-2
<b>Hold-Down Clip</b>	SFA-101 (top latch), SFA-202 (side latch)

<b>SU4S-11L</b>	
<b>Style</b>	14-blade DIN-mount/surface mount
<b>Terminal</b>	Spring clamp terminals
<b>Wire Size</b>	24-16 AWG
<b>Electrical Rating</b>	6A (using RU4), 10A (using RU2)
<b>Compatible Relay</b>	RY4S, RY42S, RU4, RU42S, RY2KS, RM2S
<b>Compatible Timer</b>	GT5Y
<b>Hold-Down Clip</b>	SFA-101 (top latch), SFA-202 (side latch)

Sockets



- On the SU2S, wires or ferrules cannot be connected to terminals 2, 3, 6, 7, 10 or 11 because neither springs nor conductive brackets are installed in these terminals.
- For socket mounting accessories, see page F-29.

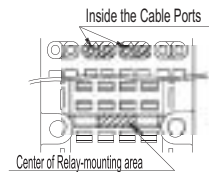

**Terminal Arrangement (top view)**

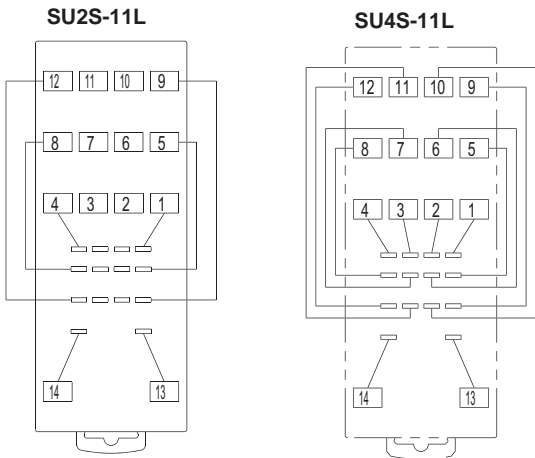

**Dimensions**

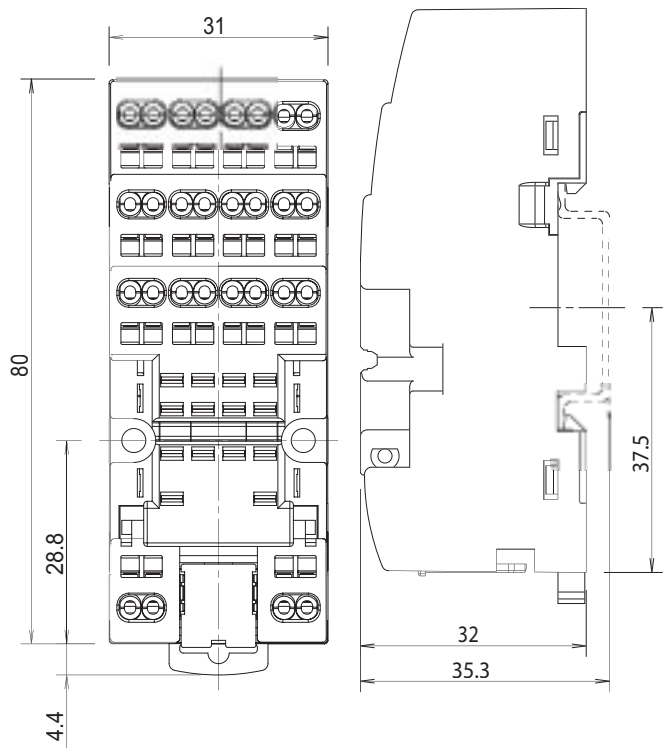

**Parts**

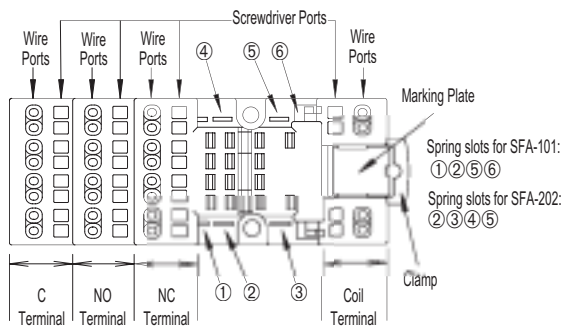

**Panel Cutout for Surface Mounting**

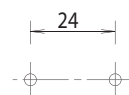

All dimensions are in mm.

## SU Series: General Instructions

### Applicable Wires

Wire	Size
Stranded wire	0.2 to 1.25 mm <sup>2</sup> or AWG24 to 16
Solid wire	0.2 to 1.5 mm <sup>2</sup> or AWG24 to 16
Wire insulation diameter	ø3.15mm maximum



- Strip the wire insulation 9 to 10mm from the end.
- In applications using ferrules for stranded wires, choose the ferrule listed in table below. Make sure that an insulation sheath is applied when using the ferrules. When using stranded wires without ferrules, make sure that the core wires have not been loosened.
- Two cable ports are provided for each terminal.

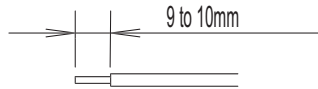

### Applicable Ferrules

Applicable Wire (stranded)		Type	Manufacturer
mm <sup>2</sup>	AWG		
0.2	24	A10.25-12BU	Phoenix Contact
-	22	A10.34-8TQ	Phoenix Contact
0.5	20	A10.5-8WH	Phoenix Contact
		A10.5-10WH	
		TE0.5	Nichifu Co. Ltd

For wiring, use the optional screwdriver (BC1S-SDO) or the following applicable screwdriver.

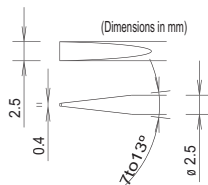

### Marking Instructions

Write markings on the SU sockets using an oil-based marker, or glue printed mylar on the marking surface. The size of the printed mylar can be 8 x 9mm maximum.

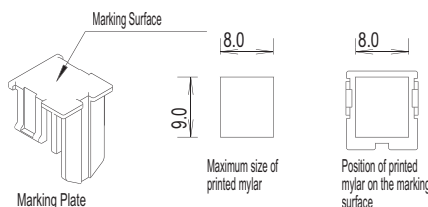

### Wiring Instructions

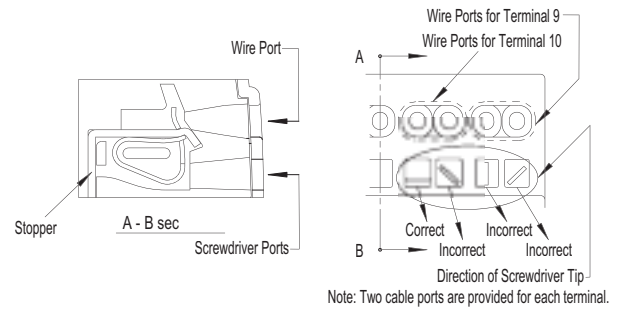

1. Insert the optional screwdriver (BC1S-SDO) or an applicable screwdriver into the square-shaped port as shown on the right, until the screwdriver tip touches the bottom of the spring.

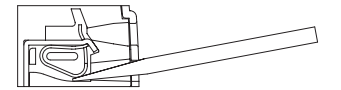

2. Push in the screwdriver until it touches the bottom of the port. The wire port is now open, and the screwdriver is held in place. The screwdriver will not come off even if you release your hand.

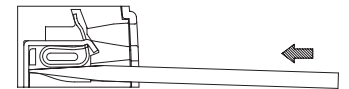

3. While the screwdriver is retained in the port, insert the wire or ferrule into the round-shaped wire port. Each wire port can accommodate one wire or ferrule. When connecting two wires to one terminal, use the adjoining port of the same terminal.

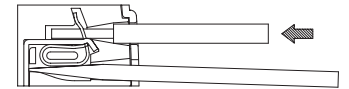

4. Pull out the screwdriver. The connection is now complete.

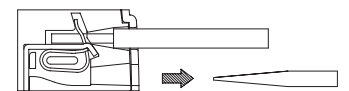

### Safety Precautions

#### Installing the Marking Plate

Because of its removable structure, the marking plate may have fallen from the socket or become loose in delivery. Make sure that the marking plate is securely installed before starting operation. The marking plate protects the conductive portion of the socket, located under the marking plate, by preventing metal fragments or pieces of wire from dropping inside. Should any such fragments enter the socket, they may cause fire hazard, damage, or malfunction.

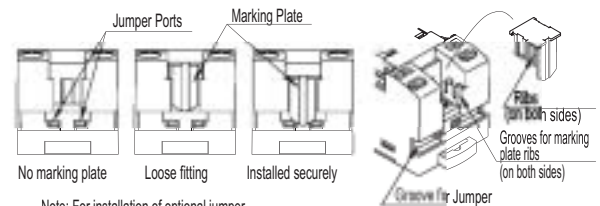

Note: For installation of optional jumper, see the instruction sheet provided with the jumper.

#### Inserting Screwdriver into the Wire Ports

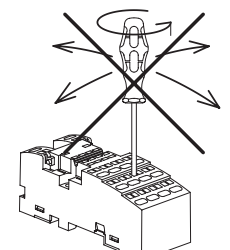



**SU Series: SU9Z-J5 Jumper Installation Instructions**

**SU9Z-J5 Jumper for SU2S-11L and SU4S-11L**

The SU9Z-J5 is used to install five sockets. When installing less than five sockets cut the jumper according to the instructions listed to the right.

The SU9Z-J5 jumper is for coil terminals only.

SU9Z-95 Jumper		
<b>Rated Current</b>	3A	
<b>Material</b>	Conductor	Nickel-plated brass
	Sheath	ABS resin

**Installation**

Loosen the marking plate on the socket.

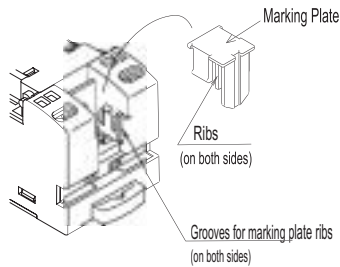
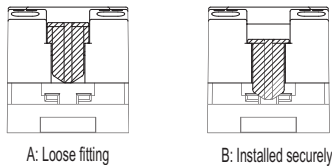

**Alignment**

Making sure that the SU9Z-J5 jumper is correctly aligned, insert the blades into the ports in the groove of the SU sockets.

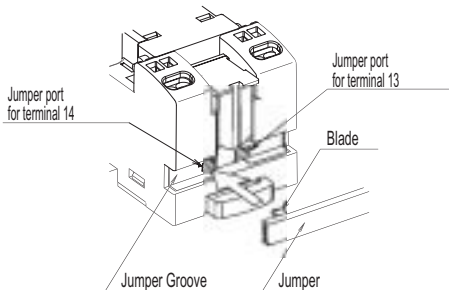
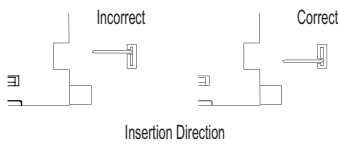

**Install Jumper Securely**

Press down the marking plate to secure the jumper. The jumper installation is now complete.

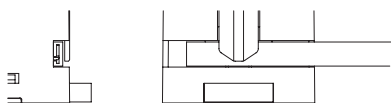

**Installing Two, Three or Four SU Sockets on the SU9Z-J5 Jumper**

As shown below, slide the jumper in the sheath so that the jumper aligns with the center of the sheath.



With the sheath properly installed on the jumper, cut the sheath and jumper at the points shown below, using cutting pliers. Referring to the drawing on the right, make sure that the sheath and jumper are cut within the cutting area. Dispose of unused portions according to local waste disposal requirements.

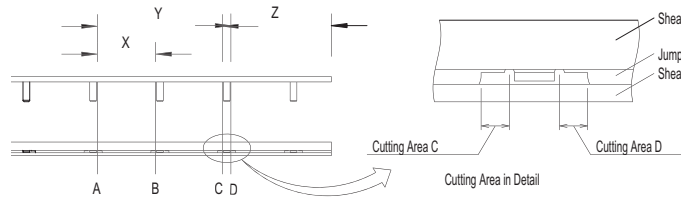

	Qty	Cutting Area	Discard
<b>2 Sockets</b>	2	A, C	Y
<b>2 Sockets</b>	1	A, B	X
<b>3 Sockets</b>			
<b>4 Sockets</b>	1	D	Z

After cutting the jumper and sheath, slide the jumper as shown below, so that the ends of the jumper are not exposed.



**Jumper Wiring to Six or More SU Sockets**

To jumper wire six or more SU sockets, connect five sockets using whole jumpers and the remaining sockets using a cut jumper. Then connect the two terminals on adjoining sockets using an applicable wire (see table below).

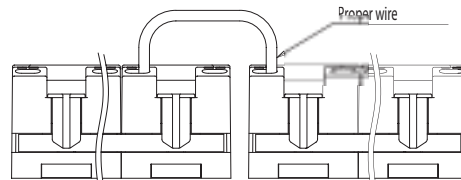

Wire	Size
<b>Stranded wire</b>	0.2 to 1.25 mm <sup>2</sup>
<b>Solid wire</b>	0.2 to 1.5 mm <sup>2</sup>
<b>AWG</b>	24 to 16



1. Use a wire with cable insulation diameter of  $\phi 3.15\text{mm}$  maximum.
2. Strip the cable insulation 9 to 10mm from the end.

**Safety Precautions**

Turn off the power to the SU9Z-J5 jumper before starting installation, removal, wiring, maintenance, or inspection of the jumper. Failure to turn power off may cause an electrical shock or fire hazard.

To avoid a short circuit due to incorrect wiring, confirm which terminals are connected to the jumper before beginning wiring.

**F**  
**Sockets**



## SJ Series: General Information



**SJ1S-05B**

<b>Style</b>	5-blade snap mount/surface mount
<b>Terminal/Torque</b>	0.6 - 1.0N•m (Maximum 1.2N•m)
<b>Wire Size</b>	Maximum up to 2 - #14 AWG
<b>Electrical Rating</b>	250V, 12A
<b>Compatible Relay</b>	RJ1S
<b>Compatible Timer</b>	N/A
<b>Hold-Down Spring</b>	N/A
<b>Replacement Locking Lever</b>	SJ9Z-C

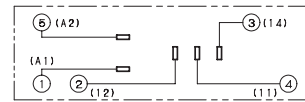
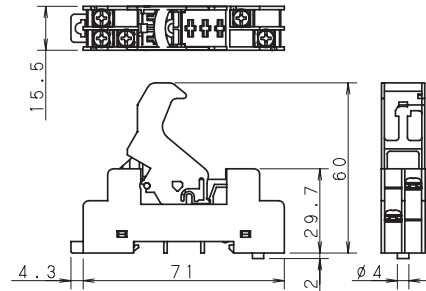

(Top View)



**SJ1S-07L Fingersafe**

<b>Style</b>	5-blade, snap mount/surface mount
<b>Terminal/Torque</b>	0.6 - 1.0N•m (Maximum 1.2N•m)
<b>Wire Size</b>	Maximum up to 2 - #14 AWG
<b>Electrical Rating</b>	250V, 12A
<b>Compatible Relay</b>	RJ1S
<b>Compatible Timer</b>	N/A
<b>Hold-Down Spring</b>	N/A
<b>Replacement Locking Lever</b>	SJ9Z-C

**SJ1S-07L**

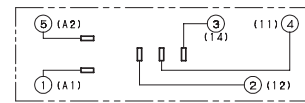
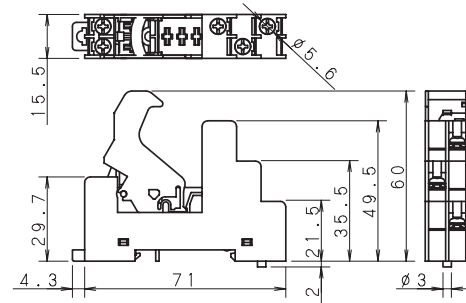

(Top View)



**SJ2S-05B**

<b>Style</b>	8-blade, snap mount/surface mount
<b>Terminal/Torque</b>	0.6 - 1.0N•m (Maximum 1.2N•m)
<b>Wire Size</b>	Maximum up to 2 - #14 AWG
<b>Electrical Rating</b>	250V, 8A
<b>Compatible Relay</b>	RJ2S
<b>Compatible Timer</b>	N/A
<b>Hold-Down Spring</b>	N/A
<b>Replacement Locking Lever</b>	SJ9Z-C

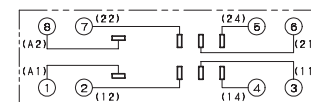
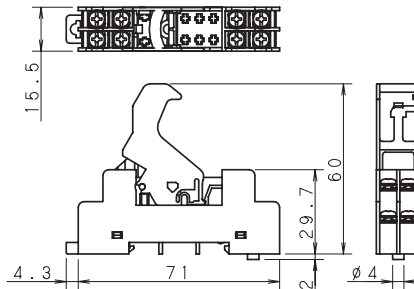

(Top View)

All dimensions are in mm.



**SJ2S-07L Fingersafe**

<b>Style</b>	8-blade snap mount/surface mount
<b>Terminal/Torque</b>	0.6 - 1.0N•m (Maximum 1.2N•m)
<b>Wire Size</b>	Maximum up to 2 - #14 AWG
<b>Electrical Rating</b>	250V, 8A
<b>Compatible Relay</b>	RJ2S
<b>Compatible Timer</b>	N/A
<b>Hold-Down Spring</b>	N/A
<b>Replacement Locking Lever</b>	SJ9Z-C

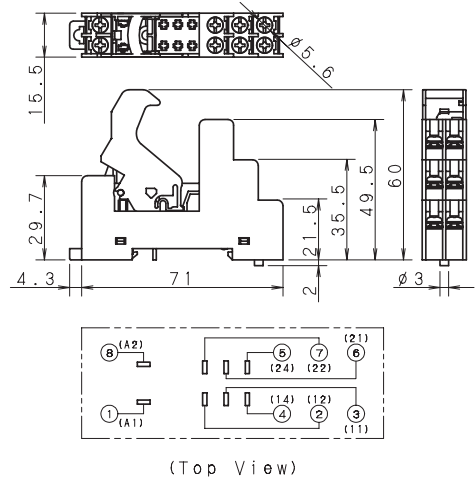

All dimensions are in mm.

**F**

**SQ Series: General Information**

**Sockets**



**SQ1V-07B Fingersafe**

<b>Style</b>	5-pin, snap mount/surface mount
<b>Terminal/Torque</b>	1.0N•m Maximum
<b>Wire Size</b>	Maximum up to 2 - #14 AWG
<b>Electrical Rating</b>	300V, 12A
<b>Compatible Relay</b>	RQ1V-CM
<b>Replacement Locking Lever</b>	SQ9Z-C
<b>Replacement Marking Plate</b>	SQ9Z-P
<b>Plug-in LED/Diode (6-24VDC)</b>	SQ9Z-LD
<b>Plug-in LED/RC (120/240VAC)</b>	SQ9Z-LR

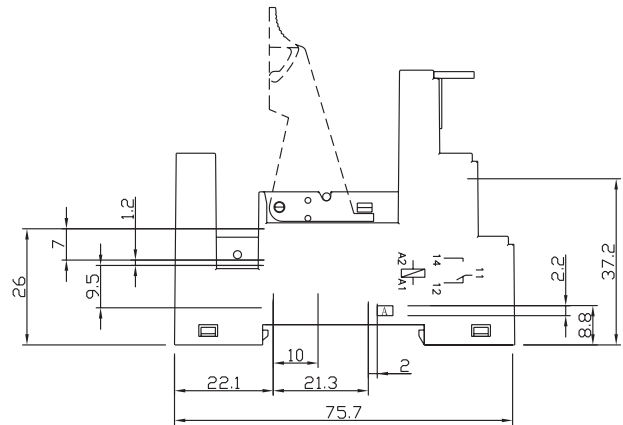

**SQ2V-07B Fingersafe**

<b>Style</b>	8-pin, snap mount/surface mount
<b>Terminal/Torque</b>	1.0N•m Maximum
<b>Wire Size</b>	Maximum up to 2 - #14 AWG
<b>Electrical Rating</b>	300V, 8A
<b>Compatible Relay</b>	RQ2V, RQ1V-CH
<b>Replacement Locking Lever</b>	SQ9Z-C
<b>Replacement Marking Plate</b>	SQ9Z-P
<b>Plug-in LED/Diode (6-24VDC)</b>	SQ9Z-LD
<b>Plug-in LED/RC (120/240VAC)</b>	SQ9Z-LR

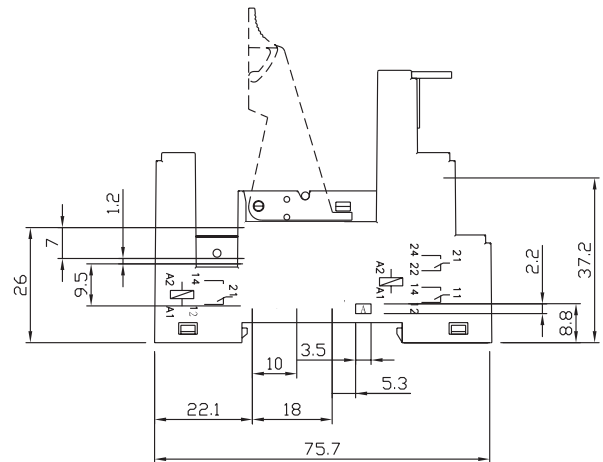

All dimensions are in mm.

## SR Series: DIN Rail Snap-Mount Sockets

### SR2P Sockets



#### SR2P-05

<b>Style</b>	8-pin octal, snap-mount/surface mount
<b>Terminal/Torque</b>	M3.5 screws with captive wire clamp (9 - 11.5 in•lbs)
<b>Wire Size</b>	Maximum up to 2-#12AWG
<b>Electrical Rating</b>	300V, 10A
<b>Compatible Relay</b>	RR2P
<b>Compatible Timer</b>	RTE-P1, GT3 (8-pin), GT5P, GE1A
<b>Hold-Down Spring</b>	SR2B-02F1 (for RR2P)
<b>Hold-Down Clip</b>	SFA-203 (for timers only, except GE1A)

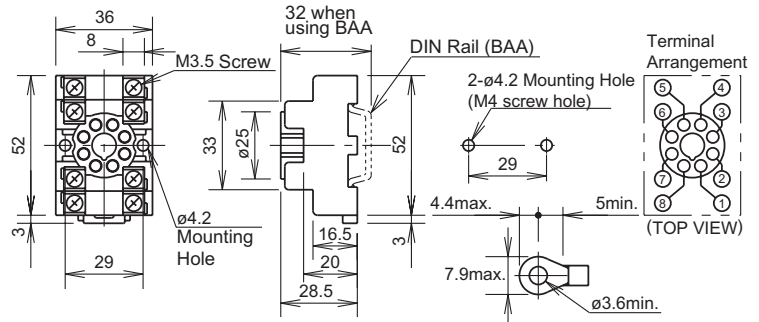

#### SR2P-05C Fingersafe

<b>Style</b>	8-pin octal, snap-mount/surface mount
<b>Terminal/Torque</b>	M3.5 screws with captive wire clamp, fingersafe (9 - 11.5 in•lbs)
<b>Wire Size</b>	Maximum up to 2-#12AWG
<b>Electrical Rating</b>	300V, 10A
<b>Compatible Relay</b>	RR2P
<b>Compatible Timer</b>	RTE-P1, GT3 (8-pin), GT5P, GE1A
<b>Hold-Down Spring</b>	SR2B-02F1 (for RR2P)
<b>Hold-Down Clip</b>	SFA-203 (for timers only, except GE1A)

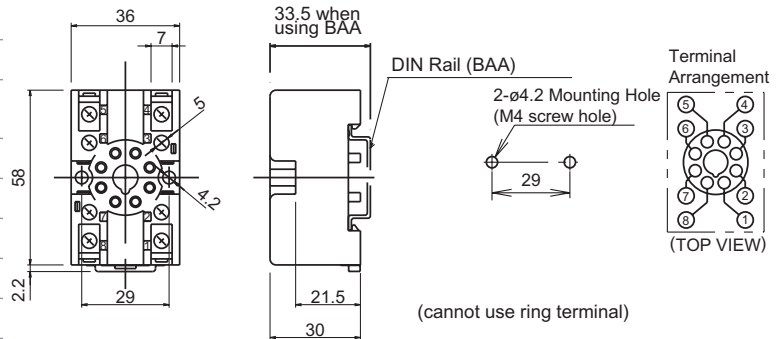

#### SR2P-06

<b>Style</b>	8-pin octal, snap-mount/surface mount
<b>Terminal/Torque</b>	M3.5 screws with captive wire clamp (9 - 11.5 in•lbs)
<b>Wire Size</b>	Maximum up to 2-#12AWG
<b>Electrical Rating</b>	300V, 10A
<b>Compatible Relay</b>	RR2P
<b>Compatible Timer</b>	RTE-P1, GT3 (8-pin), GT5P, GE1A
<b>Hold-Down Spring</b>	SR2B-02F1 (for RR2P)
<b>Hold-Down Clip</b>	SFA-202 (for timers only, except GE1A)

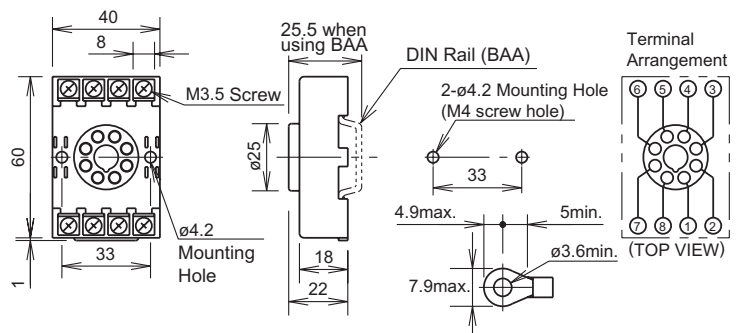

1. For socket mounting accessories, see page F-29.
2. For hold-down clip/spring selections, see page F-4.

All dimensions are in mm.

SR3P Sockets



SR3P-05

<b>Style</b>	11-pin octal, snap-mount/surface mount
<b>Terminal/Torque</b>	M3.5 screws with captive wire clamp (9 - 11.5 in•lbs)
<b>Wire Size</b>	Maximum up to 2-#12AWG
<b>Electrical Rating</b>	300V, 10A
<b>Compatible Relay</b>	RR3PA, RR2KP
<b>Compatible Timer</b>	GT3 (11-pin), RTE-P2
<b>Hold-Down Spring</b>	SR3B-02F1 for RR3P; SR3P-06F3 for RR2KP
<b>Hold-Down Clip</b>	SFA-203 (Timers)

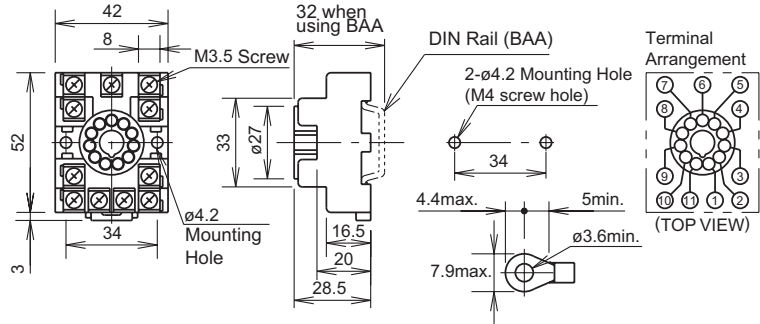

F

Sockets



SR3P-05C Fingersafe

<b>Style</b>	11-pin octal, snap-mount/surface mount
<b>Terminal/Torque</b>	M3.5 screws with captive wire clamp, fingersafe (9 - 11.5 in•lbs)
<b>Wire Size</b>	Maximum up to 2-#12AWG
<b>Electrical Rating</b>	300V, 10A
<b>Compatible Relay</b>	RR3PA, *RR2KP (*latching relay)
<b>Compatible Timer</b>	GT3 (11-pin), RTE-P2
<b>Hold-Down Spring</b>	SR3B-02F1 for RR3PA; SR3P-06F3 for RR2KP
<b>Hold-Down Clip</b>	SFA-203 (Timers)

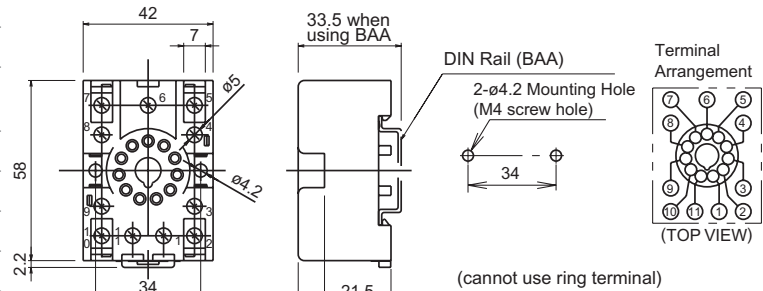

SR3P-06

<b>Style</b>	11-pin octal, snap-mount/surface mount
<b>Terminal/Torque</b>	M3.5 screws with captive wire clamp (9 - 11.5 in•lbs)
<b>Wire Size</b>	Maximum up to 2-#12AWG
<b>Electrical Rating</b>	300V, 10A
<b>Compatible Relay</b>	RR3PA, *RR2KP (*latching relay)
<b>Compatible Timer</b>	GT3 (11-pin), RTE-P2
<b>Hold-Down Spring</b>	SR3B-02F1 for RR3PA; SR3P-06F3 for RR2KP
<b>Hold-Down Clip</b>	SFA-202 (Timers)

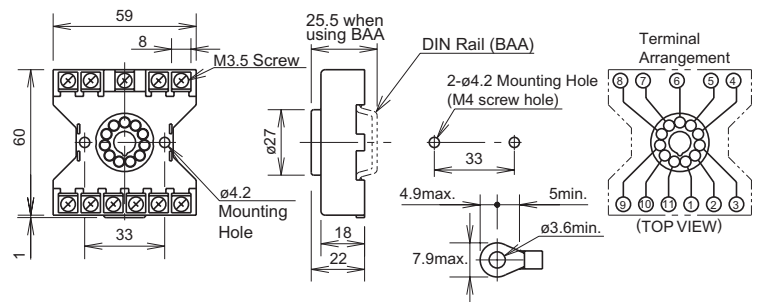

1. For socket mounting accessories, see page F-29.
2. For hold-down clip/spring selections, see page F-4.

All dimensions are in mm.

## SR3B Sockets



### SR3B-05

<b>Style</b>	11-blade, snap-mount/surface mount
<b>Terminal/Torque</b>	M3.5 screws with captive wire clamp (9 - 11.5 in•lbs)
<b>Wire Size</b>	Maximum up to 2-#12AWG
<b>Electrical Rating</b>	300V, 15A (10A)* (*denotes CSA rating)
<b>Compatible Relay</b>	RR1BA, RR2BA, RR3B
<b>Compatible Timer</b>	RTE-B
<b>Hold-Down Spring</b>	SR3B-02F1 (relays)
<b>Hold-Down Clip</b>	SFA-202 (relays and timers)

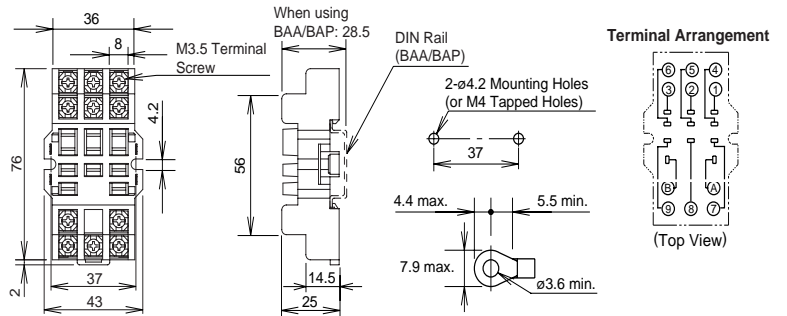

All dimensions are in mm.



1. For socket mounting accessories, see page F-29.
2. For hold-down clip/spring selections, see page F-4.

**SH Series: DIN Rail Snap-Mount Sockets**

**SH1B Sockets**



<b>SH1B-05</b>	
<b>Style</b>	5-blade, snap-mount/surface mount
<b>Terminal/Torque</b>	(Coil) M3 screws/(5.5 - 9 in•lbs) (contact) M3.5 screws (9 - 11.5 in•lbs) with captive wire clamp
<b>Wire Size</b>	Maximum up to 2-#12AWG
<b>Electrical Rating</b>	250V, 10A
<b>Compatible Relay</b>	RH1B
<b>Hold-Down Spring</b>	SY2S-02F1
<b>Hold-Down Clip</b>	SFA-101 (top notch), SFA-202 (side notch)

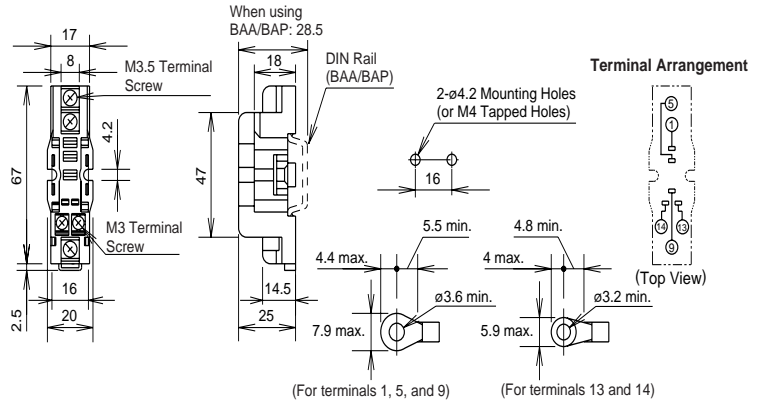

<b>SH1B-05C Fingersafe</b>	
<b>Style</b>	5-blade, snap-mount/surface mount
<b>Terminal/Torque</b>	(Coil) M3 screws/(5.5 - 9 in•lbs) (contact) M3.5 screws with captive wire clamp, fingersafe (9 - 11.5 in•lbs)
<b>Wire Size</b>	Maximum up to 2-#12AWG
<b>Electrical Rating</b>	250V, 10A
<b>Compatible Relay</b>	RH1B
<b>Hold-Down Spring</b>	SY2S-02F1
<b>Hold-Down Clip</b>	SFA-101 (top notch), SFA-202 (side notch)

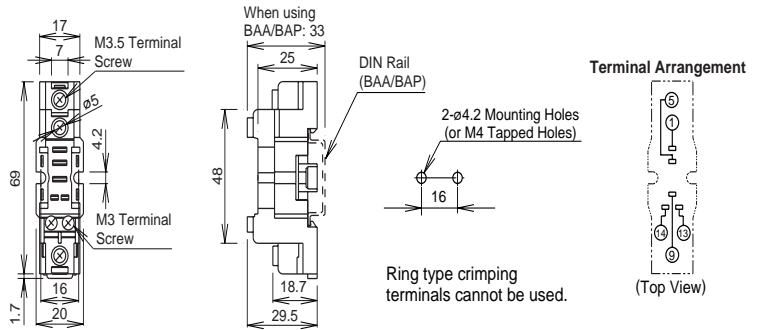

- 1. For socket mounting accessories, see page F-29.
- 2. For hold-down clip/spring selections, see page F-4.

All dimensions are in mm.

Sockets

### SH2B Sockets



#### SH2B-05

<b>Style</b>	8-blade, snap-mount/surface mount
<b>Terminal/Torque</b>	M3.5 screws with captive wire clamp (9 - 11.5 in•lbs)
<b>Wire Size</b>	Maximum up to 2-#12AWG
<b>Electrical Rating</b>	300V, 10A
<b>Compatible Relay</b>	RH2B
<b>Hold-Down Spring</b>	SY4S-02F1
<b>Hold-Down Clip</b>	SFA-101 (top notch), SFA-202 (side notch)

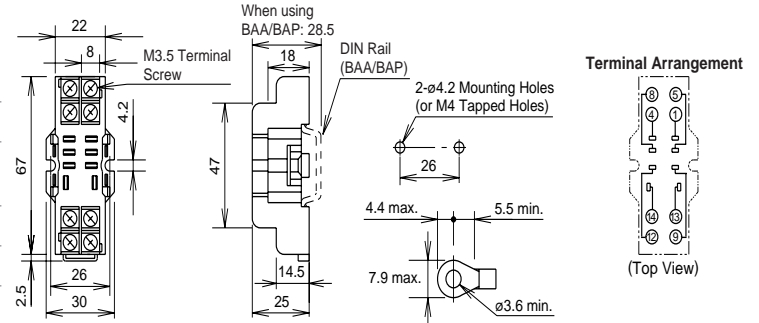

#### SH2B-05C Fingersafe

<b>Style</b>	8-blade, snap-mount/surface mount
<b>Terminal/Torque</b>	M3.5 screws with captive wire clamp, finger-safe (9 - 11.5 in•lbs)
<b>Wire Size</b>	Maximum up to 2-#12AWG
<b>Electrical Rating</b>	300V, 10A
<b>Compatible Relay</b>	RH2B
<b>Hold-Down Spring</b>	SY4S-02F1
<b>Hold-Down Clip</b>	SFA-101 (top notch), SFA-202 (side notch)

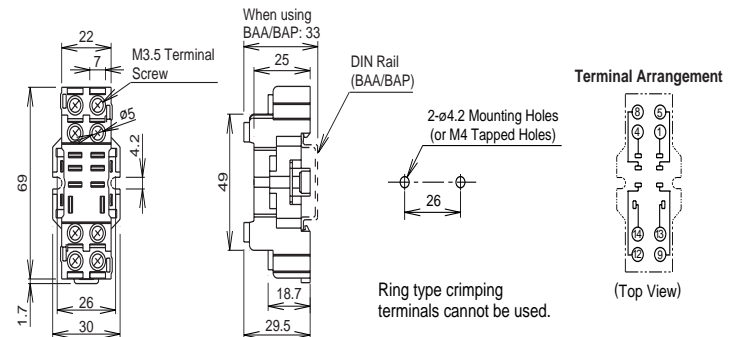

1. For socket mounting accessories, see page F-29.
2. For hold-down clip/spring selections, see page F-4.

All dimensions are in mm.



**SH3B Sockets**



**SH3B-05**

<b>Style</b>	11-blade, snap-mount/surface mount
<b>Terminal/Torque</b>	M3.5 screws with captive wire clamp (9 - 11.5 in •lbs)
<b>Wire Size</b>	Maximum up to 2-#12AWG
<b>Electrical Rating</b>	300V, 10A
<b>Compatible Relay</b>	RH3B, RH2LB
<b>Hold-Down Spring</b>	SH3B-05F1
<b>Hold-Down Clip</b>	SFA-101 (top notch), SFA-202 (side notch)

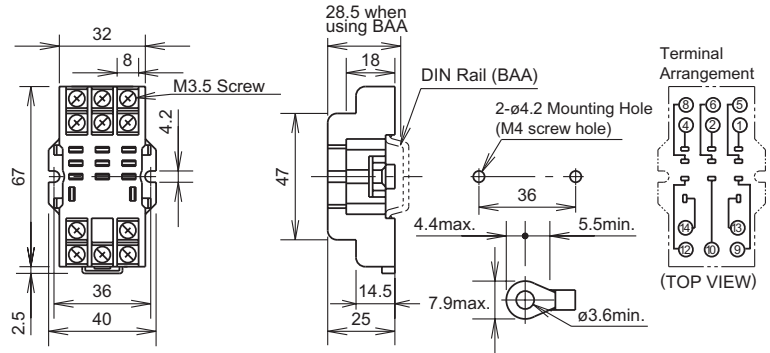

**F**

**Sockets**



**SH3B-05C Fingersafe**

<b>Style</b>	11-blade, snap-mount/surface mount
<b>Terminal/Torque</b>	M3.5 screws with captive wire clamp, fingersafe (9 - 11.5 in •lbs)
<b>Wire Size</b>	Maximum up to 2-#12AWG
<b>Electrical Rating</b>	300V, 10A
<b>Compatible Relay</b>	RH3B, RH2LB
<b>Hold-Down Spring</b>	SH3B-05F1
<b>Hold-Down Clip</b>	SFA-101 (top notch), SFA-202 (side notch)

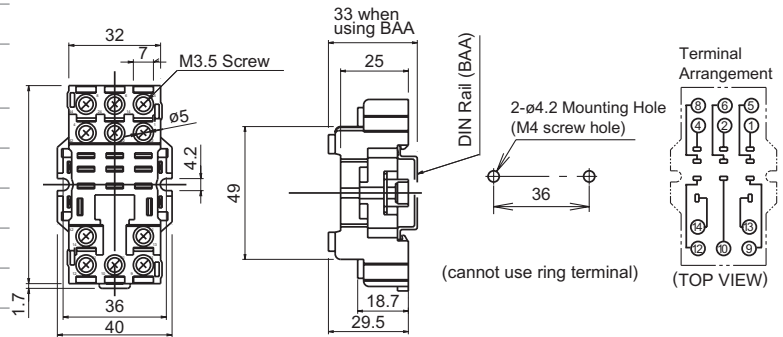

1. For socket mounting accessories, see page F-29.
2. For hold-down clip/spring selections, see page F-4.

All dimensions are in mm.

### SH4B Sockets



#### SH4B-05

<b>Style</b>	14-blade, snap-mount/surface mount
<b>Terminal/Torque</b>	M3.5 screws with captive wire clamp (9 - 11.5 in • lbs)
<b>Wire Size</b>	Maximum up to 2-#12AWG
<b>Electrical Rating</b>	300V, 10A
<b>Compatible Relay</b>	RH4B
<b>Hold-Down Spring</b>	SH4B-02F1
<b>Hold-Down Clip</b>	SFA-101 (top notch), SFA-202 (side notch)

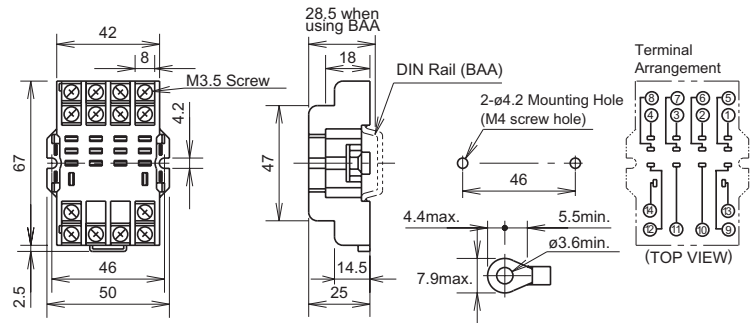

#### SH4B-05C Fingersafe

<b>Style</b>	14-blade, snap-mount/surface mount
<b>Terminal/Torque</b>	M3.5 screws with captive wire clamp, fingersafe (9 - 11.5 in • lbs)
<b>Wire Size</b>	Maximum up to 2-#12AWG
<b>Electrical Rating</b>	300V, 10A
<b>Compatible Relay</b>	RH4B
<b>Hold-Down Spring</b>	SH4B-02F1
<b>Hold-Down Clip</b>	SFA-101 (top notch), SFA-202 (side notch)

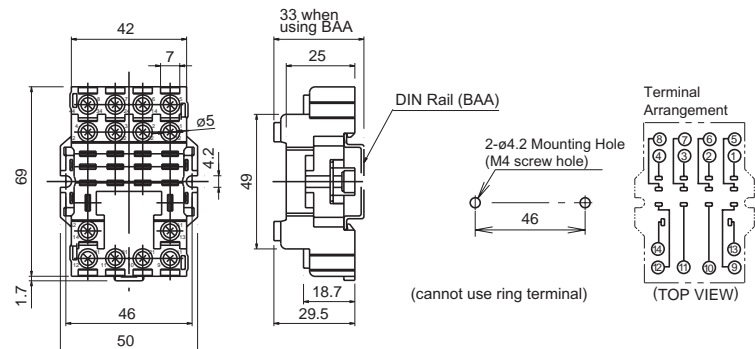

1. For socket mounting accessories, see page F-29.
2. For hold-down clip/spring selections, see page F-4.

All dimensions are in mm.

**SY Series: DIN Rail Snap-Mount Sockets**

**SY2S Sockets**



<b>SY2S-05</b>	
<b>Style</b>	8-blade, snap-mount/surface mount
<b>Terminal/Torque</b>	M3 screws with captive wire clamp (5.5 - 9 in • lbs)
<b>Wire Size</b>	Maximum up to 2-#14AWG
<b>Electrical Rating</b>	300V, 7A
<b>Compatible Relay</b>	RY2S, RY22S
<b>Hold-Down Spring</b>	SY2S-02F1
<b>Hold-Down Clip</b>	SFA-101 (top notch), SFA-202 (side notch)

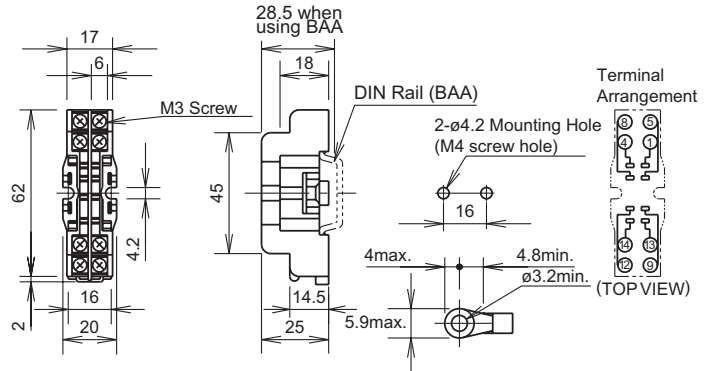

F

Sockets



<b>SY2S-05C Fingersafe</b>	
<b>Style</b>	8-blade, snap-mount/surface mount
<b>Terminal/Torque</b>	M3 screws with captive wire clamp, fingersafe (5.5 - 9 in • lbs)
<b>Wire Size</b>	Maximum up to 2-#14AWG
<b>Electrical Rating</b>	300V, 7A
<b>Compatible Relay</b>	RY2S, RY22S
<b>Hold-Down Spring</b>	SY2S-02F1
<b>Hold-Down Clip</b>	SFA-101 (top notch), SFA-202 (side notch)

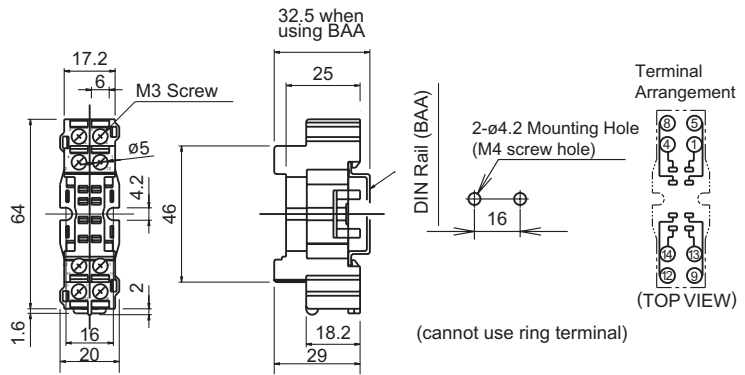

1. For socket mounting accessories, see page F-29.
2. For hold-down clip/spring selections, see page F-4.

All dimensions are in mm.

## SY4S Sockets



### SY4S-05

<b>Style</b>	14-blade, snap-mount/surface mount
<b>Terminal/Torque</b>	M3 screw with captive wire clamp (5.5 - 9 in•lbs)
<b>Wire Size</b>	Maximum up to 2-#14AWG
<b>Electrical Rating</b>	300V, 7A
<b>Compatible Relay</b>	RY4S, RY42S, RU4S, RU42S, RM2S, *RY2KS, (*latching relay)
<b>Compatible Timer</b>	GT5Y
<b>Hold-Down Spring</b>	SY4S-51F1 for all relays; SY4S-51F3 for RY2KS only
<b>Hold-Down Clip</b>	SFA-101 (top notch), SFA-202 (side notch) for all relays and timers

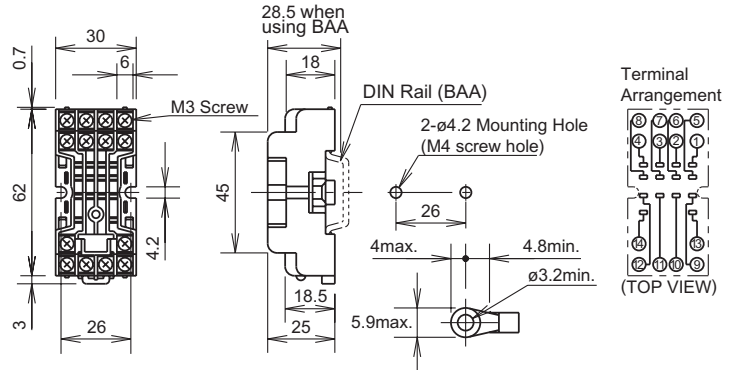

### SY4S-05C Fingersafe

<b>Style</b>	14-blade, snap-mount/surface mount
<b>Terminal/Torque</b>	M3 screw with captive wire clamp, fingersafe (5.5 - 9 in•lbs)
<b>Wire Size</b>	Maximum up to 2-#14AWG
<b>Electrical Rating</b>	300V, 7A
<b>Compatible Relay</b>	RY4S, RY42S, RM2S, RU4S, RU42S, *RY2KS, (*latching relay)
<b>Compatible Timer</b>	GT5Y
<b>Hold-Down Spring</b>	SY4S-51F1 for all relays; SY4S-51F3 for RY2KS only
<b>Hold-Down Clip</b>	SFA-101 (top notch), SFA-202 (side notch) for GT5Y timer and relays

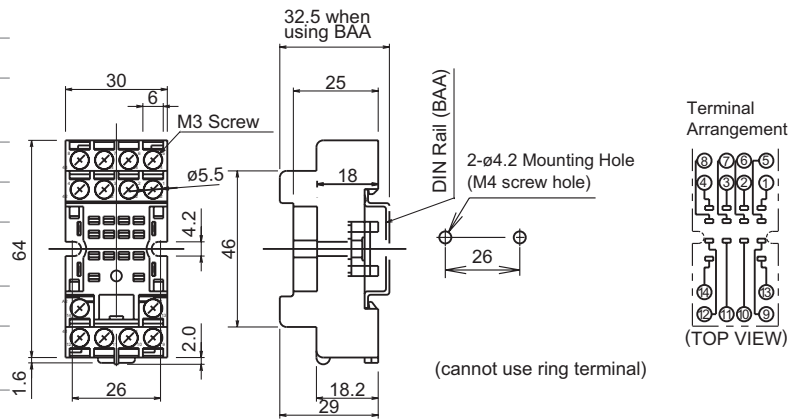

All dimensions are in mm.



1. For socket mounting accessories, see page F-29.
2. For hold-down clip/spring selections, see page F-4.

**SM2S Sockets**



**SM2S-05**

<b>Style</b>	8-blade, snap-mount/surface mount
<b>Terminal/Torque</b>	M3 screw with captive wire clamp (5.5 - 9 in •lbs)
<b>Wire Size</b>	Maximum up to 2-#14AWG
<b>Electrical Rating</b>	300V, 10A
<b>Compatible Relay</b>	RU2S, RM2S
<b>Compatible Timer</b>	—
<b>Hold-Down Spring</b>	SY4S-51F1
<b>Hold-Down Clip</b>	SFA-101 (top notch), SFA-202 (side notch)

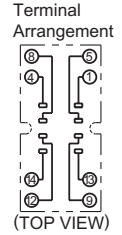
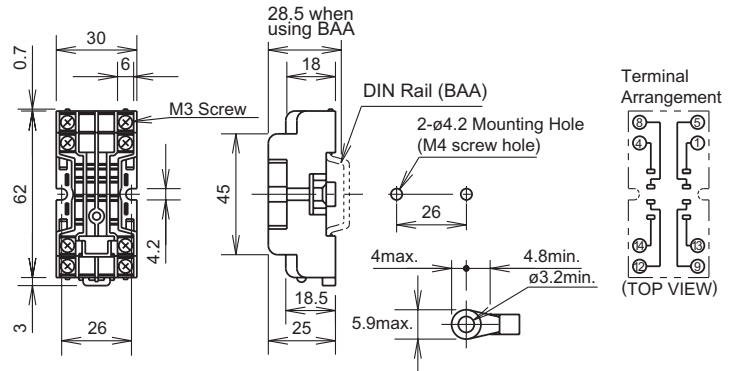

F

Sockets



**SM2S-05C Fingersafe**

<b>Style</b>	8-blade, snap-mount/surface mount
<b>Terminal/Torque</b>	M3 screw with captive wire clamp, fingersafe (5.5 - 9 in •lbs)
<b>Wire Size</b>	Maximum up to 2-#14AWG
<b>Electrical Rating</b>	300V, 10A
<b>Compatible Relay</b>	RU2S, RM2S
<b>Compatible Timer</b>	—
<b>Hold-Down Spring</b>	SY4S-51F1
<b>Hold-Down Clip</b>	SFA-101 (top notch), SFA-202 (side notch)

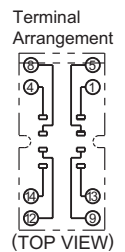
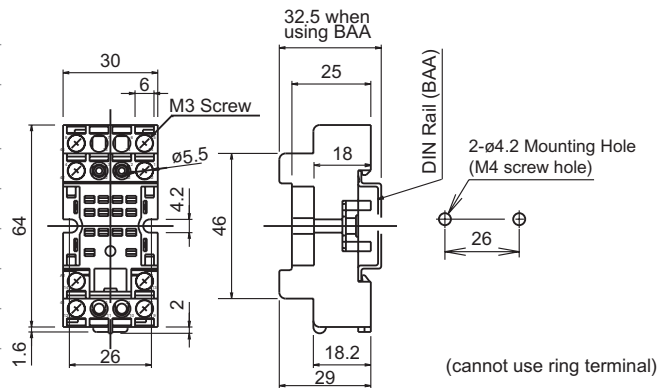

All dimensions are in mm.



1. For socket mounting accessories, see page F-29.
2. For hold-down clip/spring selections, see page F-4.

## SR Series: Panel Mount Sockets



### SR3B-51

<b>Style</b>	11-blade, panel mount
<b>Terminal</b>	Solder
<b>Electrical Rating</b>	300V, 10A
<b>Compatible Relay</b>	RR1BA, RR2BA, RR3B
<b>Compatible Timer</b>	RTE-B
<b>Hold-Down Spring</b>	SR3B-02F1 (for relays only)

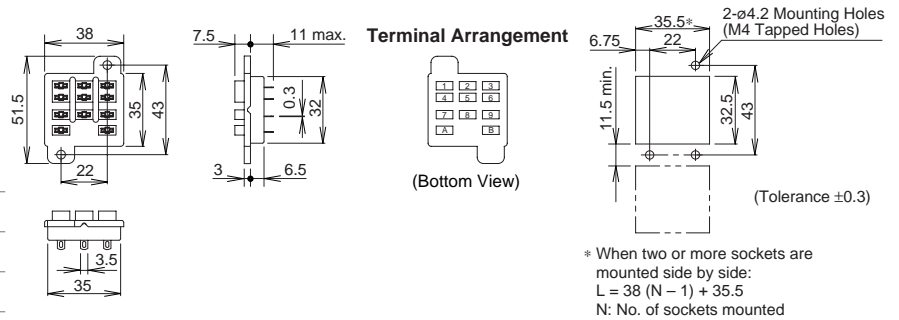

### SR2P-51

<b>Style</b>	8-pin octal, panel mount
<b>Terminal</b>	Solder
<b>Electrical Rating</b>	300V, 10A
<b>Compatible Relay</b>	RR2P
<b>Compatible Timer</b>	RTE-P1, GT3 (8-pin), GT5P
<b>Hold-Down Spring</b>	SR3P-01F1 (for relay only)
<b>Hold-Down Clip</b>	SFA-402 (for GT3 8-pin) SFA-302 (for GT5P)

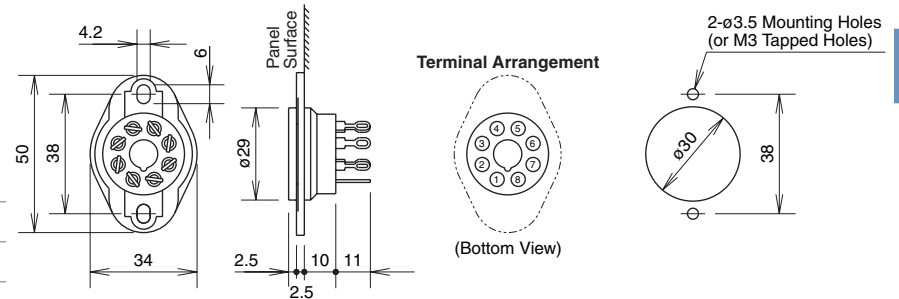

### SR3P-51

<b>Style</b>	11-pin octal, panel mount
<b>Terminal</b>	Solder
<b>Electrical Rating</b>	300V, 10A
<b>Compatible Relay</b>	RR3PA, *RR2KP (*latching relay)
<b>Compatible Timer</b>	GT3 (11-pin), RTE-P2
<b>Hold-Down Spring</b>	SR3P-01F1 for RR3PA SR3P-51F3 for RR2KP
<b>Hold-Down Clip</b>	SFA-402 (for GT3 11-pin, RTE-P2)

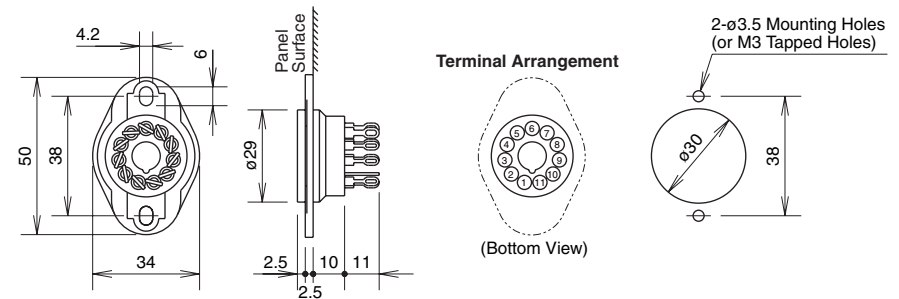

**F**  
Sockets



1. For socket mounting accessories, see page F-29.
2. For hold-down clip/spring selections, see page F-4.

All dimensions are in mm.

## SH Series: Panel Mount Sockets



## SH1B-51

<b>Style</b>	5-blade, panel mount
<b>Terminal</b>	Solder
<b>Electrical Rating</b>	300V, 10A
<b>Compatible Relay</b>	RH1B
<b>Hold-Down Spring</b>	SY4S-51F1
<b>Hold-Down Clip</b>	SFA-301 (top notch), SFA-302 (side notch)

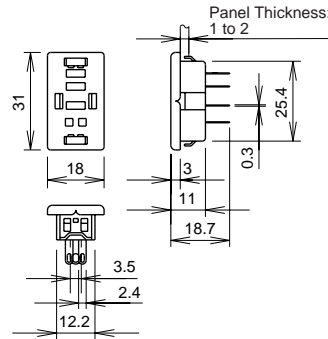

## Terminal Arrangement

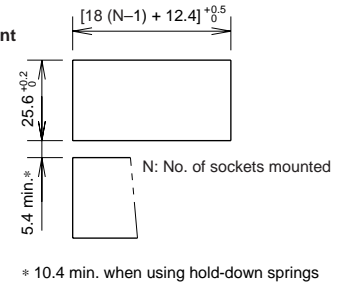
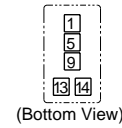

## F

## Sockets



## SH2B-51

<b>Style</b>	8-blade, panel mount
<b>Terminal</b>	Solder
<b>Electrical Rating</b>	300V, 10A
<b>Compatible Relay</b>	RH2B
<b>Hold-Down Spring</b>	SY4S-51F1 SY4S-02F1 for RH2B-4C
<b>Hold-Down Clip</b>	SFA-301 (top notch), SFA-302 (side notch)

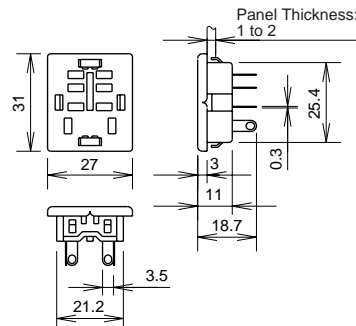

## Terminal Arrangement

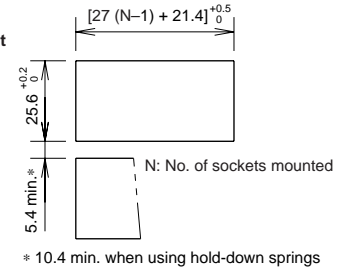
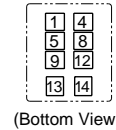

All dimensions are in mm.



1. For socket mounting accessories, see page F-29.
2. For hold-down clip/spring selections, see page F-4.



## SH Series: Panel Mount Sockets, continued



### SH3B-51

<b>Style</b>	11-blade, panel mount
<b>Terminal</b>	Solder
<b>Electrical Rating</b>	300V, 10A
<b>Compatible Relay</b>	RH3B, *RH2LB (*latching relay)
<b>Hold-Down Spring</b>	SY4S-51F1 SY4S-02F1 for RH3B-4C
<b>Hold-Down Clip</b>	SFA-301 (top notch), SFA-302 (side notch)

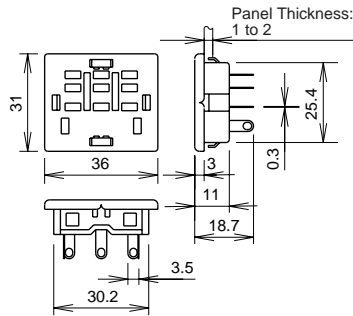

#### Terminal Arrangement

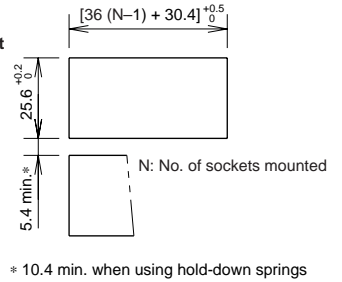
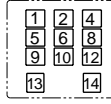

### SH4B-51

<b>Style</b>	14-blade, panel mount
<b>Terminal</b>	Solder
<b>Electrical Rating</b>	300V, 10A
<b>Compatible Relay</b>	RH4B
<b>Hold-Down Spring</b>	SY4S-51F1, SY4S-02F1
<b>Hold-Down Clip</b>	SFA-301, SFA-302

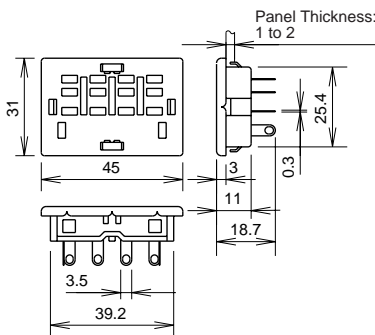

#### Terminal Arrangement

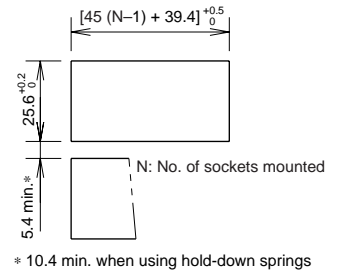
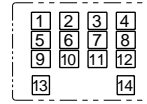

All dimensions are in mm.



1. For socket mounting accessories, see page F-29.
2. For hold-down clip/spring selections, see page F-4.

**SY Series: Panel Mount Sockets**



**SY2S-51**

<b>Style</b>	8-blade, panel mount
<b>Terminal</b>	Solder
<b>Electrical Rating</b>	300V, 7A
<b>Compatible Relay</b>	RY2S, RY22S
<b>Hold-Down Spring</b>	SY4S-51F1
<b>Hold-Down Clip</b>	SFA-301 (top notch), SFA-302 (side notch)

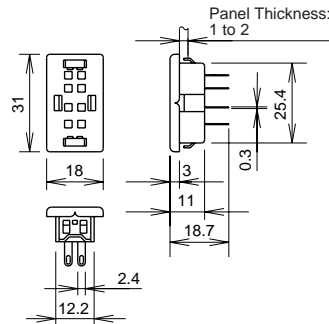

**Terminal Arrangement**

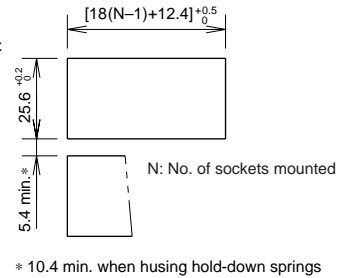
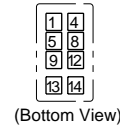

**F**

**Sockets**



**SY4S-51**

<b>Style</b>	14-blade, panel mount
<b>Terminal</b>	Solder
<b>Electrical Rating</b>	300V, 7A
<b>Compatible Relay</b>	RY4S, RY42S, RM2S, RY2KS, RU4S, RU2S, RU42S
<b>Compatible Timer</b>	GT5Y
<b>Hold-Down Spring</b>	SY4S-51F1 for all relays except; SY4S-02F3 for RY2KS relay
<b>Hold-Down Clip</b>	SFA-301 (top notch), SFA-302 (side notch)

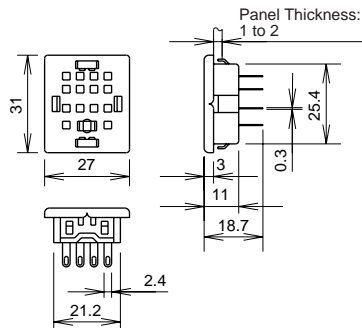

**Terminal Arrangement**

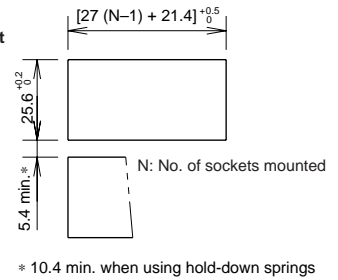
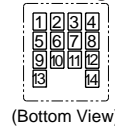

All dimensions are in mm.



1. For socket mounting accessories, see page F-29.
2. For hold-down clip/spring selections, see page F-4.

## SH Series: PC Board Mount Sockets



**SH1B-62**

<b>Style</b>	5-blade
<b>Terminal</b>	Solder/PCB mount
<b>Electrical Rating</b>	250V, 10A
<b>Compatible Relay</b>	RH1B
<b>Hold-Down Spring</b>	SY4S-51F1
<b>Hold-Down Clip</b>	SFA-301 (top notch), SFA-302 (side notch)

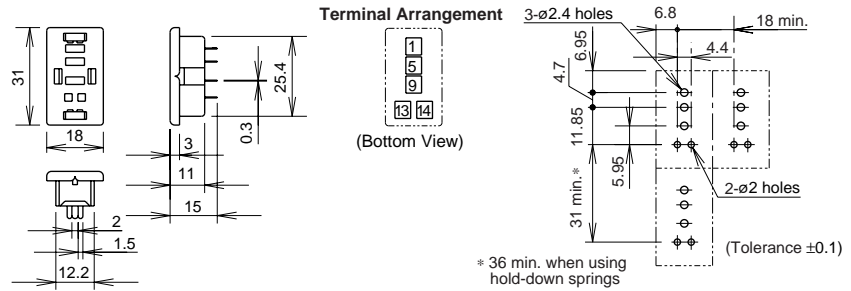

**SH2B-62**

<b>Style</b>	8-blade
<b>Terminal</b>	Solder/PCB mount
<b>Electrical Rating</b>	300V, 10A
<b>Compatible Relay</b>	RH2B
<b>Hold-Down Spring</b>	SY4S-51F1, SY4S-02F1
<b>Hold-Down Clip</b>	SFA-301 (top notch), SFA-302 (side notch)

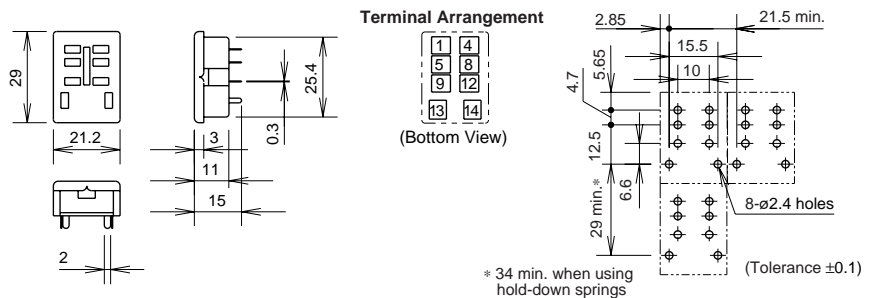

**SH3B-62**

<b>Style</b>	11-blade
<b>Terminal</b>	Solder/PCB mount
<b>Electrical Rating</b>	300V, 10A
<b>Compatible Relay</b>	RH3B, *RH2LB (*latching relay)
<b>Hold-Down Spring</b>	SY4S-51F1, SY4S-02F1
<b>Hold-Down Clip</b>	SFA-301 (top notch), SFA-302 (side notch)

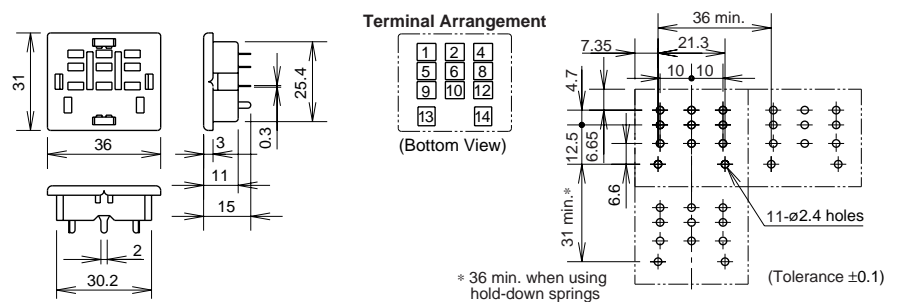

1. For socket mounting accessories, see page F-29.  
2. For hold-down clip/spring selections, see page F-4.

All dimensions are in mm.

## SH Series: PC Board Mount Sockets, continued



## SH4B-62

<b>Style</b>	14-blade
<b>Terminal</b>	Solder/PCB mount
<b>Electrical Rating</b>	300V, 10A
<b>Compatible Relay</b>	RH4B
<b>Hold-Down Springs</b>	SY4S-51F1, SH4B-02F1
<b>Hold-Down Clip</b>	SFA-301 (top notch), SFA-302 (side notch)

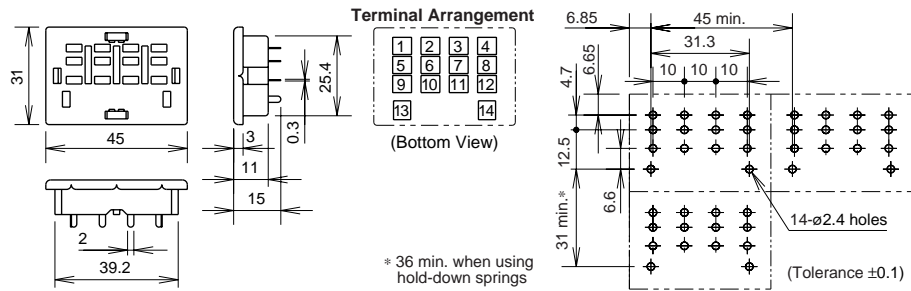

F

Sockets

## SY Series: PC Board Mount Sockets



## SY2S-61

<b>Style</b>	8-blade
<b>Terminal</b>	Solder/PCB mount
<b>Electrical Rating</b>	300V, 7A
<b>Compatible Relay</b>	RY2S, RY22S
<b>Hold-Down Spring</b>	SY4S-51F1
<b>Hold-Down Clip</b>	SFA-301 (top notch), SFA-302 (side notch)

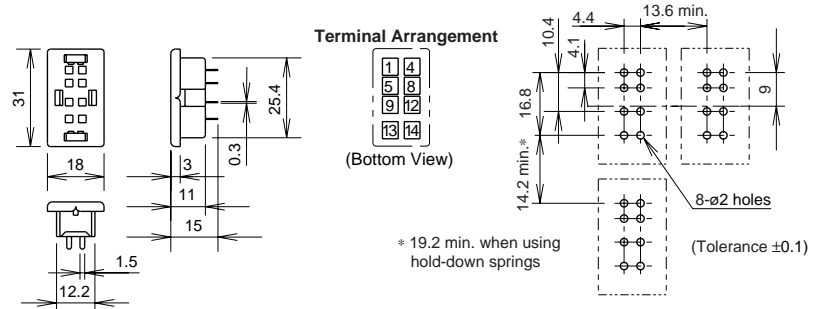

All dimensions are in mm.



1. For socket mounting accessories, see page F-29.
2. For hold-down clip/spring selections, see page F-4.

## SY Series: PC Mount Sockets, continued



### SY4S-61

<b>Style</b>	14-blade
<b>Terminal</b>	Solder/PCB mount
<b>Electrical Rating</b>	300V, 7A
<b>Compatible Relay</b>	RY4S, RY42S, RM2S, *RY2KS, RU4S, RU42S, RU2S (*latching relay)
<b>Compatible Timer</b>	GT5Y
<b>Hold-Down Spring</b>	SY4S-51F1, SY4S-02F1
<b>Hold-Down Clip</b>	SFA-301 (top notch; except GT5Y and RY2KS) SFA-302 (side notch for all)

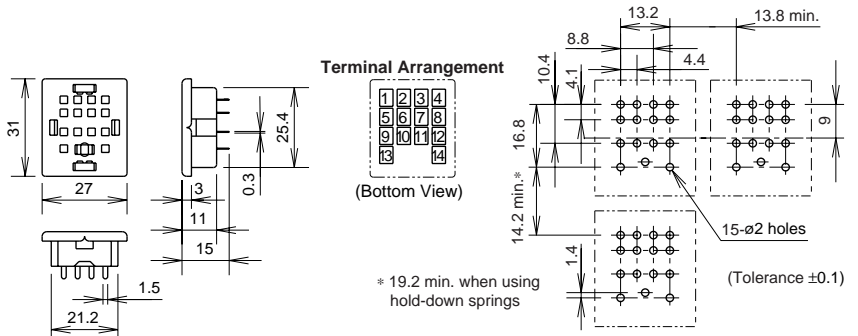

### SY4S-62

<b>Style</b>	14-blade
<b>Terminal</b>	Solder/PCB mount
<b>Electrical Rating</b>	250V, 7A
<b>Compatible Relay</b>	RY4S, RY42S, RU4S, RU42S, *RY2KS (*latching relay)
<b>Compatible Timer</b>	GT5Y
<b>Hold-Down Spring</b>	SY4S-51F1, SY4S-51F3, SY4S-51F4, *SY4S-02F1, *SY4S-02F3 (*when mounting a relay with check button)

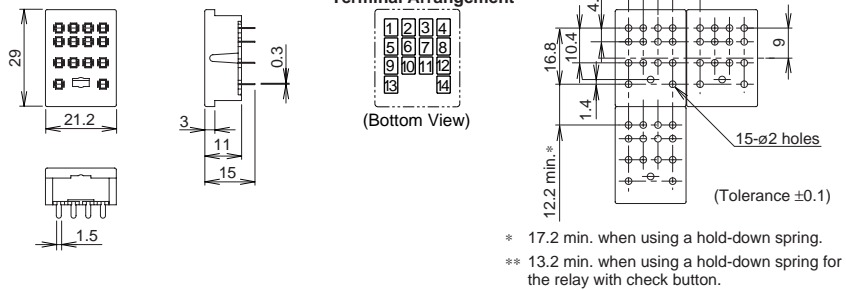

All dimensions are in mm.



1. For socket mounting accessories, see page F-29.
2. For hold-down clip/spring selections, see page F-4.

**SR Series: Socket for Panel Mounted Timers**

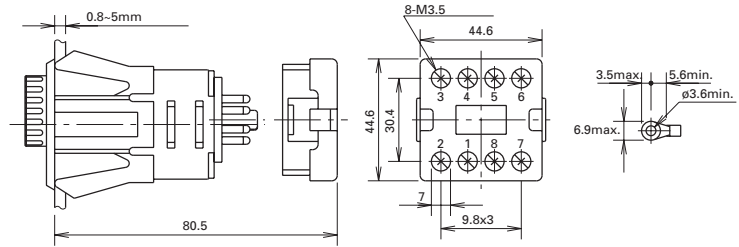

**SR6P-M08G**

<b>Style</b>	8-pin
<b>Terminal</b>	M3.5 screws with captive wire clamp
<b>Electrical Rating</b>	300V, 10A
<b>Wire Size</b>	Maximum up to 2-#12AWG
<b>Compatible Timer</b>	GT3 (8-pin), RTE-P1, GE1A
<b>Hold-Down Spring</b>	SY4S-02F1

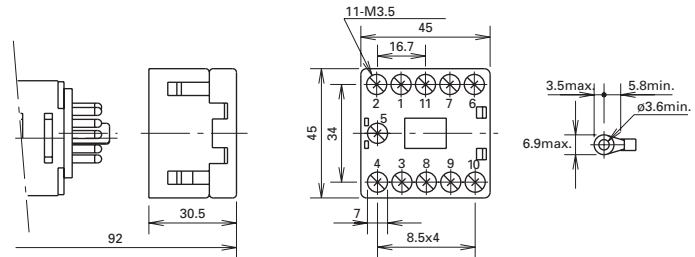

**SR6P-M11G**

<b>Style</b>	11-pin
<b>Terminal</b>	M3.5 screws with captive wire clamp
<b>Electrical Rating</b>	300V, 10A
<b>Wire Size</b>	Maximum up to 2-#12AWG
<b>Compatible Timer</b>	GT3 (11-pin), RTE-P2
<b>Hold-Down Spring</b>	-----

All dimensions are in mm.

**F**  
**Sockets**



1. For socket mounting accessories, see page F-29.
2. For hold-down clip/spring selections, see page F-4.

## Accessories

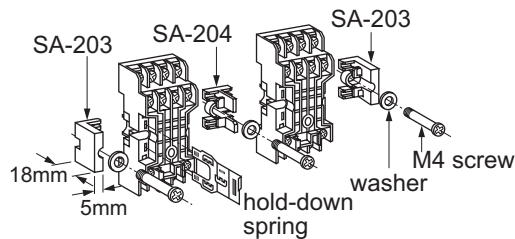

Description	Appearance	Use with	Part No.	Remarks
<b>Aluminum DIN Rail</b> (1 meter length)		All DIN rail sockets	BNDN1000	IDEC offers a low-profile DIN rail (BNDN1000). The BNDN1000 is designed to accommodate snap-mount sockets. Made of durable extruded aluminum, the BNDN-1000 measures 0.413 in height and 1.37 (35mm) in width (DIN standard). Standard length is 39" (1,000mm).
<b>DIN Rail End Stop</b>		DIN rail	BNL5	9.1 mm wide.
<b>Surface Mount End Connector</b>		SY2S, SY4S, SR3B, SH1B, SH2B, SH3B, SH4B	SA-203	For use on ends of socket groupings when surface mounting.
			SA-204	For use between adjoining sockets when surface mounting.
<b>Surface Mount Connector</b>		SY2S, SY4S, SR3B, SH1B, SH2B, SH3B, SH4B	SA-405	For use between adjoining sockets when surface mounting.
<b>DIN Rail Spacer</b>		All DIN rail sockets	SA-406	
<b>Steel Mounting Plates</b> (for panel mount sockets)		SY4S-51, SH2B-51	SA-402	11.42" length with 10 holes.
		SY4S-51, SH2B-51	SA-403	23.33" length with 21 holes.
<b>Relay Holders</b>		RH2B, RM2S, RY4S, RY42S, RU4S, RU42S	RH-01	For diagram, see next page.
		RY2S, RH1B	RH-03	
<b>Replacement Hold-Down Spring Anchor</b>		Horseshoe clip for all DIN rail sockets except SR*P-05(C)	Y778-011	For use with hold-down springs (bale wire types) or DIN rail mount sockets. 2 pieces included with each socket.
<b>Hold-Down Spring for SR*P-05(C)</b>		Chair clip for SR*P-05(C)	Y703-102	For SR2P-05, SR2P-05C, SR3P-05, SR3P-05C

F

Sockets



**Instructions**

**Mounting Snap-Mount Sockets**

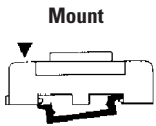

Figure 1

Snap-mount sockets are designed to mount on the BNDN-1000 mounting rail. The built-in mounting clip eliminates mounting hardware and reduces mounting time by 80%.

To mount see Figure 1. Place the end of the socket (end opposite of mounting clip against the outer edge of the rail). Press the socket down firmly until the clip snaps onto the mounting rail. To remove see Figure 2. Pull out the mounting clip with a screwdriver, and lift the socket.

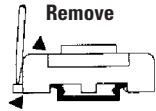
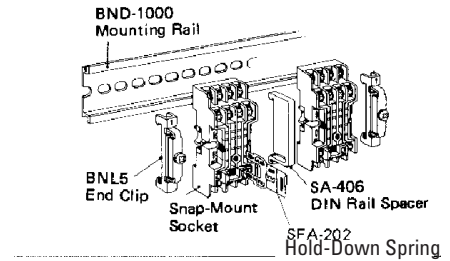

Figure 2

For spacing between adjoining sockets, use the SA-406 DIN rail spacer. Spacers are 0.195" wide. Spacing can be adjusted according to the number of spacers added. Spacers snap on and off easily like snap-mount sockets.

To prevent side-to-side movement, use a BNL-5 end clip at **each** end of every socket row.



**Mounting Relay Holders**

**F**  
**Sockets**

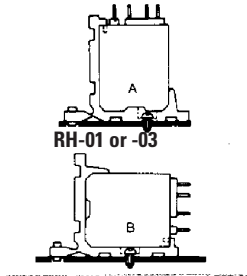

Figure 1

Mount directly onto panel boards in two alternate positions: A and B (see Figure 1).

To mount the relay into the holder, hook the bottom edge of the relay case (coil terminal side) onto the relay holder (see Figure 2).

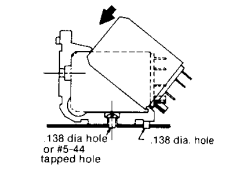

Figure 2

Push down until the relay snaps into place.

**Mounting Hold-Down Springs**

Take the two anchor clips (horseshoe / U-shaped piece) that come with the socket and insert into the slits on both sides of the socket. Make sure the raised notches on the anchor clip face into the socket.

Plug relay into socket

Insert the open ends of the hold-down spring into either the first or second hole of the anchor clip. The relay-spring combination will determine which hole should be used.

Slide spring over relay.

## Dimensions

### Surface Mount Sockets (SH2B-02)

IDEC surface mount sockets (SH2B-02) are also designed to mount individually or collectively on a flat surface without the use of a DIN rail. Use the mounting screw between adjoining sockets and at the outer ends of the row of sockets.

#### Dimension Table

Socket Part No.	Dimension A
SH2B-02	1.14"

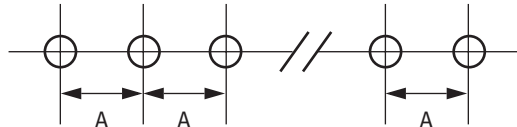

 1. Drawing is not to scale.

### Snap-Mount Sockets

Snap-mount sockets are designed to mount individually or collectively without using a rail. Use a SA-405 connector or SA-204 connector between adjoining sockets (see Figures 1 and 2). Use the SA-203 end connector at the outer ends of each socket row when using the SA-204 connector (see Figure 2).

#### Dimension Table

Socket Part No.	Dim. B	Dim. C	Dim. D
SY2S-05, SY2S-05C	0.669"	0.826"	0.866"
SY4S-05, SY4S-05C	1.024"	1.181"	1.220"
SR3B-05	1.496"	1.693"	1.732"
SH1B-05, SH1B-05C	0.630"	0.787"	0.827"
SH2B-05, SH2B-05C	1.024"	1.181"	1.220"
SH3B-05, SH3B-05C	1.417"	1.575"	1.614"
SH4B-05, SH4B-05C	1.811"	1.969"	2.008"

#### Using an SA-406 Connector

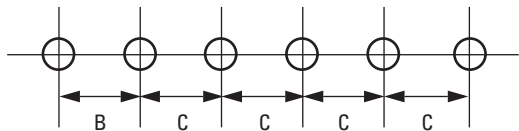

#### Using SA-203 or SA-204 Connectors

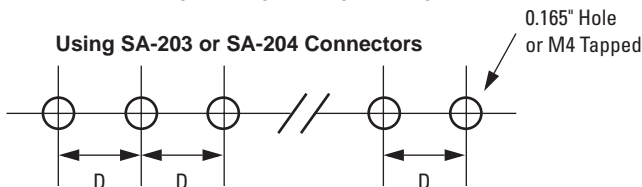

 2. Drawings are not to scale.

**Dimensions, continued**

**Collective Panel Mounting**

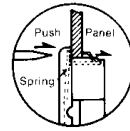
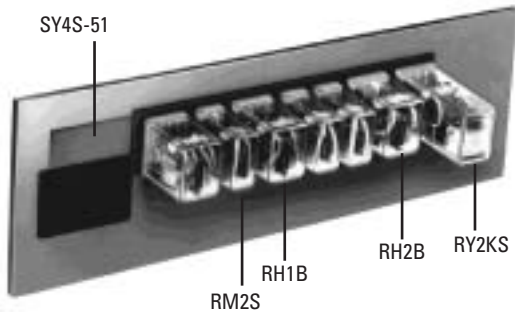

Figure 1

SH and SY series panel mount sockets are designed to mount collectively in panel cut-outs. Insert socket with mounting springs facing the top and bottom edge of the panel cut-out. Push the socket until the mounting spring clips onto the panel. (See Figure 1.)

**Dimension Table**

Part No.	Width	Relay
SY4S-51	1.063"	RY4S, RY42, RY2KS, RM2S
SH4B-51	1.772"	RH4B
SH3B-51	1.418"	RH3B, RH2LB
SH2B-51	1.063"	RH2B
SH1B-51	0.709"	RH1B
SY2S-51	0.709"	RY2S, RY22S

**How to Calculate Cutout Length (L)**

**Cutout L = A (Total Overall Width of Each Socket) – 0.221" (+ 0", – 0.020")**

Example:

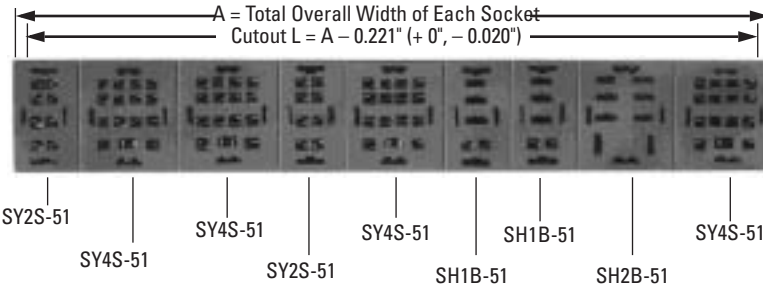

$L = [0.709" + 1.063" + 1.063" + 0.709" + 1.063" + 0.709" + 1.063" + 1.063"] - 0.221" = 7.93"$

$L = 7.93" (+ 0", - 0.020")$

**Mounting Plate**

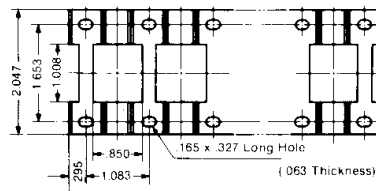

F  
Sockets