

Form 85™ Unilet® Conduit Outlet Bodies

For use with Rigid Steel, Rigid Aluminum, IMC, and EMT Conduit.

Fittings

FITTINGS: CONDUIT BODIES

Applications

- Serve as pulling fittings.
- Make bends in conduit system.
- Provide openings for splicing.
- Connect and change direction of conduit runs.
- Allow connections for branch runs.
- Permit access to conductors for maintenance.

Features

- Roomy interiors: more wiring space.
- Smooth, rounded integral bushings in hubs protect conductor insulation.
- Accurately tapped, tapered threads for tight, rigid joints and excellent ground continuity.
- Form 85 copperfree aluminum Unilets are lightweight, self-oxidizing, self-renewing and offer a high corrosion resistance.
- Lightweight aluminum facilitates shipping, handling and installing.
- Sizes with flat-back design ideal where fitting is mounted flat against surface.
- 1/2" to 3" blank covers are domed for extra wiring space.

Standard Materials

- Bodies: copperfree (max. 4/10 of 1%) aluminum
 - 1/2" thru 2": pressure cast
 - 2-1/2" thru 4": sand cast
- Blank covers: malleable iron, steel or aluminum
- Cover screws: stainless steel
- Gaskets: neoprene or composition fiber

Standard Finishes

- Aluminum bodies: epoxy powder coat
- Stamped aluminum covers: natural finish
- Cast aluminum covers: epoxy powder coat

Certifications and Compliances

- UL Standards: 514A, 514B
- UL Listed: E2527
- CSA Standard: C22.2 No. 18.3
- CSA Certified: 065183
- NEMA Standard: FB-1

Options

- PVC coating available on all threaded bodies and select covers. Add suffix **-PVC** to catalog number.
- For fully assembled body, cover and gasket, add suffix **-ACGA**.

Related Products

- For explosionproof conduit outlet bodies and boxes, see *Enclosures and Junction Boxes*.



Conduit Body with Stamped Aluminum Cover. 2" Type C shown.









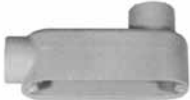

Typical Form 85 Conduit Bodies with Setscrews.
For use with Electrical Metallic Tubing (EMT).

Form 85™ Aluminum Unilet® Conduit Outlet Bodies

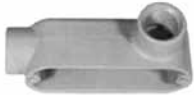
Threaded Type for use with Rigid Metal Conduit and IMC; Setscrew Type for use with Electrical Metallic Tubing (EMT).

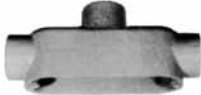
Appleton Form 85™ Conduit Bodies: Threaded/SetScrew Type *

Hub Size (Inches)	C		E		LB		LL	
	Threaded Type ‡	Setscrew Type	Threaded Type ‡	Setscrew Type	Threaded Type ‡	Setscrew Type	Threaded Type ‡	Setscrew Type
								
1/2	C50-A	C50T-A	E50-A	E50T-A	LB50-A	LB50T-A	LL50-A	LL50T-A
3/4	C75-A	C75T-A	E75-A	—	LB75-A	LB75T-A	LL75-A	LL75T-A
1	C100-A	C100T-A	E100-A	—	LB100-A	LB100T-A	LL100-A	LL100T-A
1-1/4	C125-A	C125T-A	—	—	LB125-A	LB125T-A	LL125-A	LL125T-A
1-1/2	C150-A	C150T-A	—	—	LB150-A	LB150T-A	LL150-A	LL150T-A
2	C200-A	—	—	—	LB200-A	LB200T-A	LL200-A	LL200T-A
2-1/2	C250-A	—	—	—	LB250-A	—	LL250-A	—
3	C300-A	—	—	—	LB300-A	—	LL300-A	—
3-1/2	C350-A	—	—	—	LB350-A	—	LL350-A	—
4	C400-A	—	—	—	LB400-A	—	LL400-A	—
Hub Size (Inches)	LR		T		TB		X	
	Threaded Type ‡	Setscrew Type	Threaded Type ‡	Setscrew Type	Threaded Type ‡	Setscrew Type	Threaded Type ‡	Setscrew Type
								
1/2	LR50-A	LR50T-A	T50-A	T50T-A	TB50-A	—	X50-A	—
3/4	LR75-A	LR75T-A	T75-A	T75T-A	TB75-A	—	X75-A	—
1	LR100-A	LR100T-A	T100-A	T100T-A	TB100-A	—	X100-A	—
1-1/4	LR125-A	LR125T-A	T125-A	—	TB125-A	—	—	—
1-1/2	LR150-A	LR150T-A	T150-A	—	TB150-A	—	—	—
2	LR200-A	LR200T-A	T200-A	—	TB200-A	—	—	—
2-1/2	LR250-A	—	T250-A	—	—	—	—	—
3	LR300-A	—	T300-A	—	—	—	—	—
3-1/2	LR350-A	—	T350-A	—	—	—	—	—
4	LR400-A	—	T400-A	—	—	—	—	—

Back Style for Form 85 Unilet Conduit Body Sizes (Inches)

Unilet Body	Flat Back	Round Back
C, LB, LL, LR, T	1/2 – 2	2-1/2 – 4
TB	1-1/4, 1-1/2	1/2, 3/4, 1, 2
E, X	1/2 – 1	—

* Refer to following page for Wiring Capacity Table.







‡ PVC coating available on threaded bodies. Add suffix -PVC to catalog number.

Covers and Gaskets for Form 85® Unilet® Conduit Outlet Bodies and Wiring Capacity

Covers Furnished with Stainless Steel Fastening Screws.

Fittings: CONDUIT BODIES

Covers and Gaskets

Body Size (Inches)	Blank Stamped Steel ‡	Blank Cast Malleable	Neoprene	Composition Fiber
	 Domed: 1/2" – 3"	 Flat: 1/2" – 2"		
	 Flat: 3-1/2" – 6"	 Domed: 2-1/2" – 4"	Tear out inner section to convert to "open type" gasket.	
1/2	K50-A	K50-CA	GK50-N	GK50-V
3/4	K75-A	K75-CA	GK75-N	GK75-V
1	K100-A	K100-CA	GK100-N	GK100-V
1-1/4	K125 & 150-A	K125 & 150-CA	GK125-150-N	GK125-150-V
1-1/2	K125 & 150-A	K125 & 150-CA	GK125-150-N	GK125-150-V
2	K200-A	K200-CA	GK200-N	GK200-V
2-1/2	K250 & 300-A	K250 & 300-CA	GK250-300-N	GK-250-300-V
3	K250 & 300-A	K250 & 300-CA	GK250-300-N	GK-250-300-V
3-1/2	K350 & 400-A	K350 & 400-CA	GK350-400-N	GK-350-400-V
4	K350 & 400-A	K350 & 400-CA	GK350-400-N	GK-350-400-V

Wiring Capacity: Combine Body and Cover Capacities for Total Usable Capacity per NEC 314.16(A)

Hub Size (Inches)	Capacity (in ³ /dm ³)										
	C	E	LB	LL LR	LRL	T	TA	TB	X	Stamped Cover	Cast Cover
1/2	4.00/ 0.07	4.00/ 0.07	4.00/ 0.07	4.00/ 0.07	—	4.00/ 0.07	—	6.00/ 0.10	4.00/ 0.07	0.50/ 0.01	0.00/ 0.00
3/4	7.00/ 0.11	7.00/ 0.11	7.00/ 0.11	7.00/ 0.11	—	7.00/ 0.11	—	7.00/ 0.11	7.00/ 0.11	0.80/ 0.01	0.30/ 0.00
1	11.80/ 0.19	11.80/ 0.19	11.80/ 0.19	11.80/ 0.19	—	11.80/ 0.19	—	13.00/ 0.21	11.80/ 0.19	1.00/ 25.4	0.50/ 0.01
1-1/4	34.80/ 0.57	—	34.80/ 0.57	34.80/ 0.57	—	34.80/ 0.57	—	35.00/ 0.57	—	2.50/ 0.04	0.80/ 0.01
1-1/2	35.00/ 0.57	—	35.00/ 0.57	35.00/ 0.57	—	35.00/ 0.57	—	34.50/ 0.57	—	2.50/ 0.04	0.80/ 0.01
2	70.00/ 1.15	—	70.00/ 1.15	70.00/ 1.15	—	70.00/ 1.15	—	71.00/ 1.16	—	6.50/ 0.11	1.00/ 0.02
2-1/2	143.00/ 2.34	—	139.00/ 2.28	140.50/ 3568.7	—	146.00/ 2.39	—	—	—	18.00/ 0.29	30.00/ 0.49
3	180.00/ 2.95	—	177.00/ 2.90	175.00/ 2.87	—	185.00/ 3.03	—	—	—	18.00/ 0.29	30.00/ 0.49
3-1/2	303.00/ 4.97	—	300.00/ 4.92	300.00/ 4.92	—	314.00/ 5.15	—	—	—	—	50.00/ 0.82
4	340.00/ 5.57	—	330.00/ 5.41	330.00/ 5.41	—	345.00/ 5.65	—	—	—	—	50.00/ 0.82

‡ PVC coating available on select steel covers. Add suffix **-PVC** to catalog number.

Form 85® Aluminum Unilet® Conduit Outlet Bodies Dimensions

Threaded Type for use with Rigid Metal Conduit and IMC; Setscrew Type for use with Electrical Metallic Tubing (EMT).

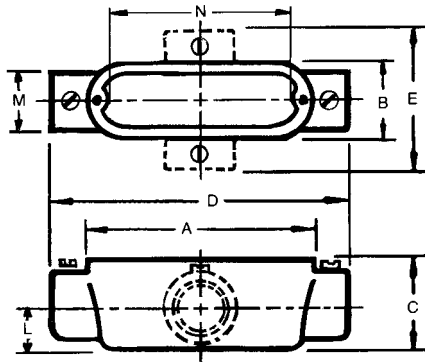

Types C, T

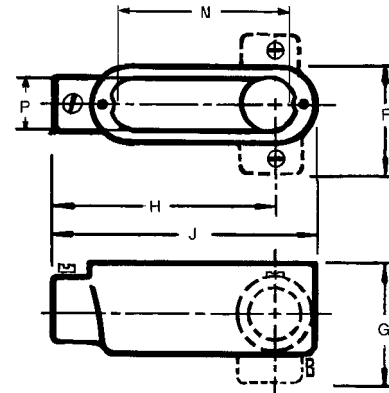

Types E, LB, LL, LR

Hub Size (Inches)	Dimensions In Inches/Millimeters												
	A	B	C	D	E	F	G	H	J	L	M	N	P
Pressure Cast													
1/2	3.94/ 100.1	1.31/ 33.3	1.38/ 35.1	4.75/ 120.7	2.56/ 65.0	2.00/ 50.8	2.06/ 52.3	3.50/ 88.9	4.31/ 109.5	0.63/ 16.0	1.13/ 28.7	3.14/ 79.8	1.05/ 26.7
3/4	4.63/ 117.6	1.56/ 39.6	1.63/ 41.4	5.63/ 143.0	3.00/ 76.2	2.25/ 57.2	2.44/ 62.0	4.13/ 104.9	5.13/ 130.3	0.75/ 19.1	1.38/ 35.1	3.78/ 96.0	1.27/ 32.3
1	5.38/ 136.7	1.81/ 46.0	1.88/ 47.8	6.69/ 169.9	3.50/ 88.9	2.63/ 66.8	2.81/ 71.4	4.88/ 124.0	6.00/ 152.4	0.94/ 23.9	1.69/ 42.9	4.50/ 114.3	1.52/ 38.6
1-1/4	7.19/ 182.6	2.50/ 63.5	2.75/ 69.9	8.56/ 217.4	—	3.50/ 88.9	3.88/ 98.6	6.56/ 166.6	7.88/ 200.2	1.06/ 26.9	2.13/ 54.1	6.00/ 152.4	2.25/ 57.2
1-1/2	7.19/ 182.6	2.50/ 63.5	2.75/ 69.9	8.56/ 217.4	—	3.50/ 88.9	3.81/ 96.8	6.44/ 163.6	7.88/ 200.2	1.19/ 30.2	2.38/ 60.5	6.00/ 152.4	2.25/ 57.2
2	9.50/ 241.3	3.13/ 79.5	3.44/ 87.4	10.81/ 274.6	—	4.19/ 106.4	4.56/ 115.8	8.31/ 211.1	10.19/ 258.8	1.50/ 38.1	2.94/ 74.7	8.06/ 204.7	2.75/ 69.9
Sand Cast													
2-1/2	12.25/ 311.2	4.31/ 109.5	3.88/ 98.6	15.13/ 384.3	7.19/ 182.6	5.75/ 146.1	5.25/ 133.4	11.88/ 301.8	13.69/ 347.7	1.81/ 46.0	3.38/ 85.9	10.63/ 270.0	3.69/ 93.7
3	12.25/ 311.2	4.31/ 109.5	4.63/ 117.6	15.13/ 384.3	7.19/ 182.6	5.75/ 146.1	6.00/ 152.4	11.56/ 293.6	13.69/ 347.7	2.19/ 55.6	4.13/ 104.9	10.63/ 270.0	3.69/ 93.7
3-1/2	14.88/ 378.0	5.50/ 139.7	5.19/ 131.8	18.13/ 460.5	8.75/ 222.3	7.13/ 181.1	6.81/ 173.0	14.00/ 355.6	16.50/ 419.1	2.50/ 63.5	4.75/ 120.7	13.13/ 333.5	4.88/ 124.0
4	14.88/ 378.0	5.50/ 139.7	5.56/ 141.2	18.13/ 460.5	8.75/ 222.3	7.13/ 181.1	7.19/ 182.6	13.75/ 349.3	16.50/ 419.1	2.75/ 69.9	5.13/ 130.3	13.13/ 333.5	4.88/ 124.0