



Compact Fluorescent

**6" Step Baffle  
Single Vertical Lamp  
IC & Non-IC**

**Recessed**

Type \_\_\_\_\_

-09 -14 -28 -31 -36 -20  
P8066

Catalog No.	Finish						Dimensions (Inches)	
	Brushed Nickel	Brushed Copper	White	Black	Chestnut	Antique Bronze	A	B
P8066	-09	-14	-28	-31	-36	-20	7-3/4	6-11/32

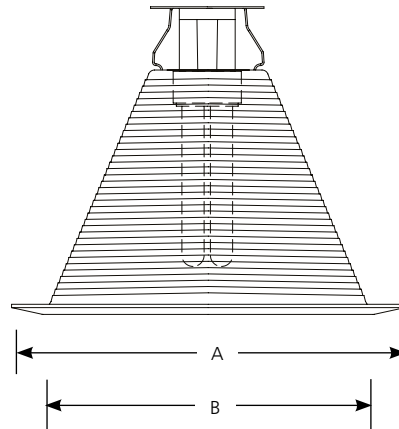

**Lamp Wattage**

Housing	IC	Non-IC
P83-AT	13w 4-pin Quad/Triple-tube CF	13w 4-pin Quad/Triple-tube CF
P83-ICAT	13w 4-pin Quad/Triple-tube CF	13w 4-pin Quad/Triple-tube CF
P88-ICAT	18w 4-pin Quad/Triple-tube CF	18w 4-pin Quad/Triple-tube CF
P183-EB	13w 4-pin Triple-tube CF	13w 4-pin Triple-tube CF
P83-26ICAT	26w 4-pin Triple-tube CF	26w 4-pin Triple-tube CF
P62-FB	N/A	26 or 32w 4-pin Triple-tube CF

**Specifications:**

Flange

- Bright white powdered painted metal flange
- Integral to trim
- No light leaks around trim flange
- Covers irregular ceiling openings
- Nickel and Copper flange is brushed in same finish
- Flange on Chestnut and Antique matches interior finish

Trim

- One-piece aluminum construction
- White and Black finishes are powder coated
- Nickel and Copper finishes are anti-iridescent anodized
- Trim-Lok action forces trim to fit snugly against the ceiling
- Socket mounts to trim for optimum performance and consistent lamp position
- Multi-groove baffle

Lamps

- Maximum overall length of lamp cannot exceed 5.5" (5-1/2")
- Available are: GE -F26TBX, Phillips PLT26, Sylvania CF26 or 32DT, or Progress 7808-01 (26w)

Labels

- UL-CUL damp location listed

Progress Lighting  
701 Millennium Blvd.  
Greenville, South Carolina  
29607

www.progresslighting.com  
Patent# 5,758,979, 5,758,980

Rev. 2/07

# P83

## P83 with P8066-28

Report No. 98029

No. Lamps: 1 Type Lamp: 13W QUAD CF-GE Total Lumens: 860

Fixture Efficiency: 55.1%

S/MH Ratio: 1.4

### Single Fixture Data

Ceiling Ht.(Ft.)	10% Values		Zero Degrees Ft.-C	50% Values	
	Beam Angle - 109			Beam Angle - 69	
	Ft.-C	Beam Dia.		Ft.-C	Beam Dia.
8	0.6	16	5.7	2.8	8
10	0.3	21	3.1	1.5	10
12	0.2	27	1.9	1.0	13
14	0.1	32	1.3	0.7	16
16	0.1	38	0.9	0.5	19

Ft.-C (Footcandles) are initial and measured 2'-6" from floor

### Quick Calculator Charts

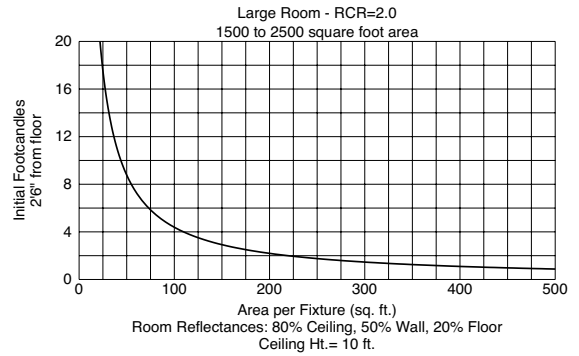
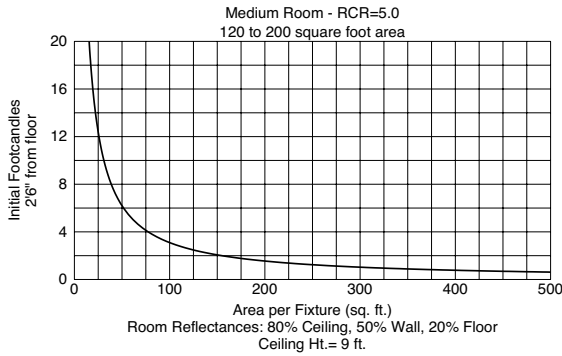

#### DISTRIBUTION CURVE

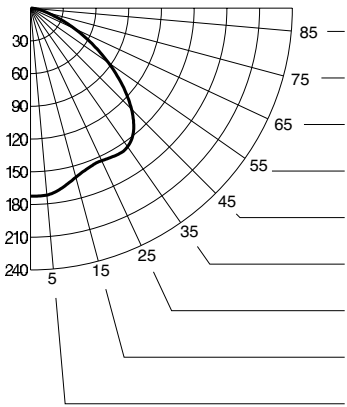

#### INTENSITY DATA

DEGREES	CANDELA
90	0
85	3
80	9
75	16
70	28
65	45
60	65
55	87
50	110
45	131
40	147
35	155
30	156
25	154
20	156
15	161
10	167
5	172
0	172

#### ZONAL CAVITY COEFFICIENTS OF UTILIZATION

Effective Floor Cavity Reflectance 0.20

RC	Effective Floor Cavity Reflectance 0.20																						
	80				70				50				30				10				0		
RW	70	50	30	10	70	50	30	10	50	30	10	50	30	10	50	30	10	50	30	10	0		
0	66	66	66	66	64	64	64	64	61	61	61	59	59	59	56	56	56	55	55	55	55		
1	61	58	56	54	59	57	55	53	55	53	52	53	51	50	51	50	49	48	48	48	48		
2	56	51	48	45	54	50	47	44	48	46	43	47	44	42	45	43	42	40	40	40	40		
3	51	45	41	38	50	45	41	37	43	40	37	41	39	36	40	38	36	34	34	34	34		
4	47	40	36	32	45	40	35	32	38	35	32	37	34	31	36	33	31	30	30	30	30		
5	43	36	31	28	42	35	31	28	34	30	27	33	30	27	32	29	27	26	26	26	26		
6	40	32	28	24	39	32	27	24	31	27	24	30	26	24	29	26	24	22	22	22	22		
7	37	29	25	21	36	29	24	21	28	24	21	27	24	21	27	23	21	20	20	20	20		
8	34	27	22	19	33	26	22	19	26	22	19	25	21	19	24	21	19	18	18	18	18		
9	32	25	20	17	31	24	20	17	24	20	17	23	19	17	22	19	17	16	16	16	16		
10	30	23	18	15	29	22	18	15	22	18	15	21	18	15	21	18	15	14	14	14	14		





Incandescent

**6" Step Baffle  
IC & Non-IC**

**Recessed**

Type \_\_\_\_\_  
 -09 -14 -28 -31 -36 -20  
 P8066

Catalog No.	Finish						Dimensions (Inches)	
	Brushed Nickel	Brushed Copper	White	Black	Chestnut	Antique Bronze	A	B
P8066	-09	-14	-28	-31	-36	-20	7-3/4	6-11/32

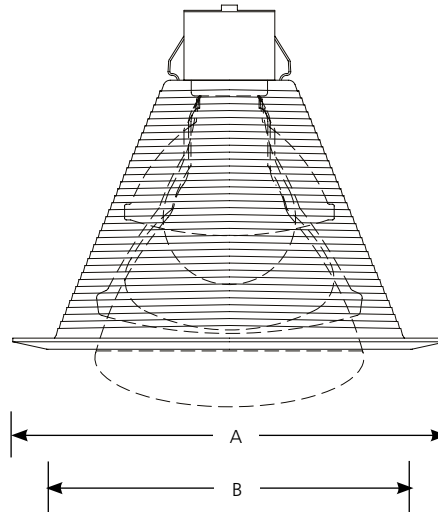

**Lamp Wattage**

Housing	IC	Non-IC
P87-AT	75PAR30/65BR30	120BR40/150PAR38/40A19
P87-ATQC	75PAR30/65BR30	120BR40/150PAR38/40A19
P187-TG	75PAR30/65BR30	120BR40/150PAR38/40A19
P821-AT	120BR40/150PAR38/100A19	120BR40/150PAR38/100A19
P821-FB, P821-FBFC	N/A	150R40/150BR40/150PAR38/40A19

**Specifications:**

Flange

- Bright white powdered painted metal flange
- Integral to trim
- No light leaks around trim flange
- Covers irregular ceiling openings
- Nickel and Copper flange is brushed in same finish
- Flange on Chestnut and Antique matches interior finish

- Socket mounts to trim for optimum performance and consistent lamp position
- Multi-groove baffle
- White and black finishes are powder coated
- Nickel and Copper finishes are anti-iridescent anodized
- Can be used in 45° sloped ceilings with P87-AT, P87-ATQC, and P187-TG housings

Trim

- One-piece aluminum construction
- Trim-Lok action forces trim to fit snugly against the ceiling

Labels

- UL-CUL damp location listed

Progress Lighting  
 701 Millennium Blvd.  
 Greenville, South Carolina  
 29607

www.progresslighting.com  
 Patent# 5,758,979, 5,758,980





# P87-AT

## P87-AT WITH P8066-31

Report No. 98098

No. Lamps: 1 Type Lamp: 150PAR38 - SYLVANIA Total Lumens: 2200

Fixture Efficiency: 95.6%

S/MH Ratio: 0.5

### Single Fixture Data

Ceiling Ht.(Ft.)	10% Values		Zero Degrees Ft.-C	50% Values	
	Beam Angle - 51			Beam Angle - 30	
	Ft.-C	Beam Dia.		Ft.-C	Beam Dia.
8	16.5	5	165.4	82.7	3
10	8.9	7	89.0	44.5	4
12	5.5	9	55.4	27.7	5
14	3.8	11	37.8	18.9	6
16	2.7	13	27.5	13.7	7

Ft.-C (Footcandles) are initial and measured 2'-6" from floor

### Quick Calculator Charts

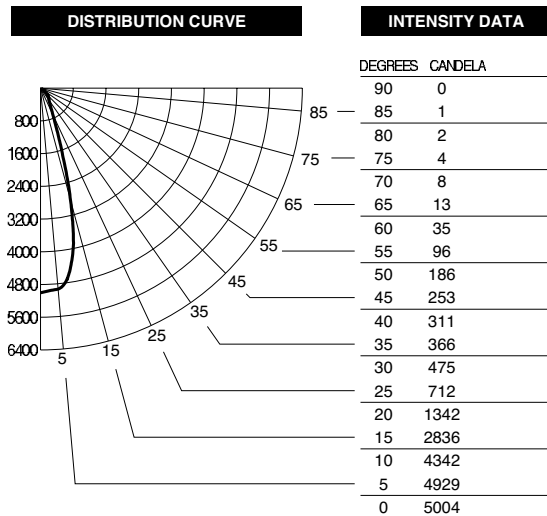
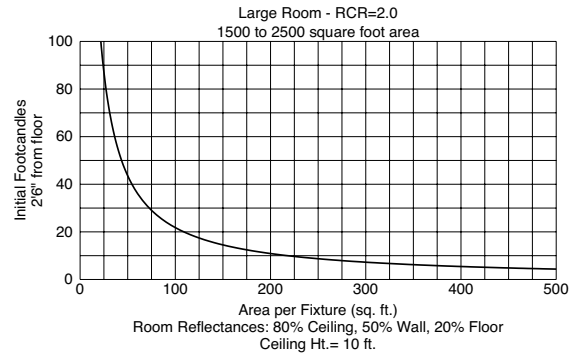
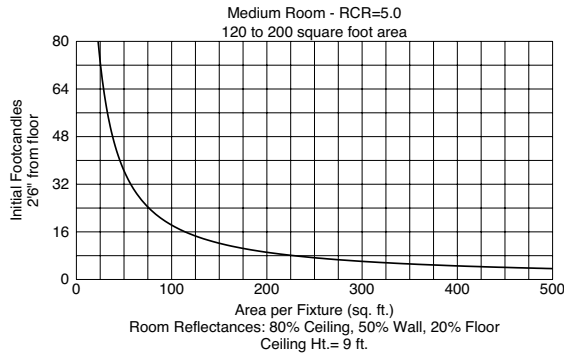

#### ZONAL CAVITY COEFFICIENTS OF UTILIZATION

Effective Floor Cavity Reflectance 0.20

RC	Effective Floor Cavity Reflectance 0.20																						
	80				70				50				30				10				0		
RW	70	50	30	10	70	50	30	10	50	30	10	50	30	10	50	30	10	50	30	10	0		
0	114	114	114	114	111	111	111	111	106	106	106	102	102	102	98	98	98	96					
1	109	106	104	102	106	104	102	100	100	99	97	97	96	94	94	93	92	90					
2	104	99	96	93	102	98	94	92	95	92	90	92	90	88	89	88	86	84					
3	99	93	89	85	97	92	88	85	90	86	83	87	84	82	85	83	81	79					
4	95	88	83	79	93	87	82	79	85	81	78	83	80	77	81	78	76	75					
5	90	83	78	74	89	82	77	74	81	76	73	79	75	72	78	74	72	71					
6	87	79	74	70	85	78	73	70	77	72	69	75	72	69	74	71	68	67					
7	83	75	70	66	82	74	69	66	73	69	66	72	68	65	71	68	65	64					
8	80	72	66	63	79	71	66	63	70	66	62	69	65	62	68	65	62	61					
9	77	68	63	60	76	68	63	60	67	63	60	66	62	59	66	62	59	58					
10	74	66	61	57	73	65	60	57	65	60	57	64	60	57	63	59	57	56					

# P87-AT

## P87-AT WITH P8066-31

Report No. 98099

No. Lamps: 1 Type Lamp: 40A19 Total Lumens: 495

Fixture Efficiency: 23.0%

S/MH Ratio: 1.3

### Single Fixture Data

Ceiling Ht.(Ft.)	10% Values		Zero Degrees Ft.-C	50% Values	
	Beam Angle - 107			Beam Angle - 64	
	Ft.-C	Beam Dia.		Ft.-C	Beam Dia.
8	0.2	15	1.7	0.9	7
10	0.1	20	0.9	0.5	9
12	0.1	26	0.6	0.3	12
14	0.0	31	0.4	0.2	14
16	0.0	36	0.3	0.1	17

Ft.-C (Footcandles) are initial and measured 2'-6" from floor

### Quick Calculator Charts

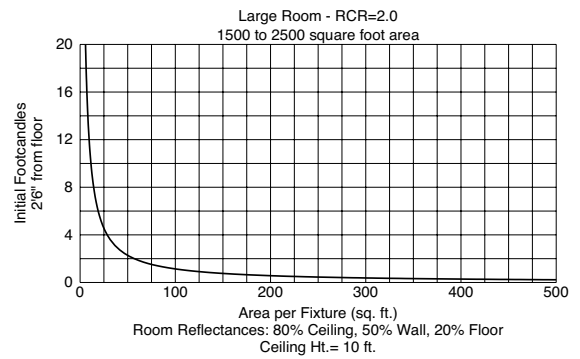
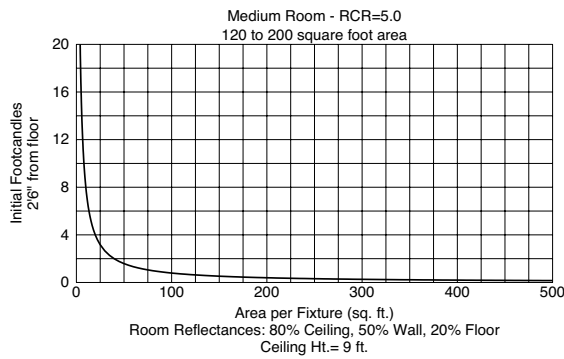

#### DISTRIBUTION CURVE

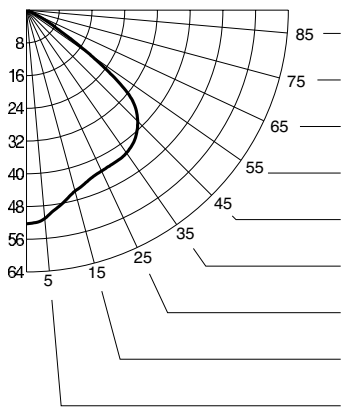

#### INTENSITY DATA

DEGREES	CANDELA
90	0
85	0
80	0
75	0
70	0
65	2
60	7
55	19
50	33
45	38
40	41
35	43
30	43
25	43
20	44
15	46
10	48
5	51
0	52

#### ZONAL CAVITY COEFFICIENTS OF UTILIZATION

Effective Floor Cavity Reflectance 0.20

RC	80				70				50				30				10				0					
	70	50	30	10	70	50	30	10	50	30	10	50	30	10	50	30	10	50	30	10	50	30	10	50	30	10
0	28	28	28	28	27	27	27	27	26	26	26	25	25	25	24	24	24	23	23	23	22	22	22	21	21	21
1	26	25	24	24	25	25	24	23	24	23	23	23	22	22	22	22	22	21	21	21	21	21	21	20	20	20
2	24	23	21	20	23	22	21	20	21	20	20	21	20	19	20	19	19	18	18	18	18	18	17	17	17	16
3	22	20	19	17	22	20	18	17	19	18	17	19	18	17	18	17	16	16	16	16	16	16	15	15	15	14
4	21	18	16	15	20	18	16	15	17	16	15	17	16	15	16	15	14	14	14	14	14	14	13	13	13	12
5	19	16	15	13	19	16	14	13	16	14	13	15	14	13	15	14	13	13	13	13	13	13	12	12	12	11
6	18	15	13	12	17	15	13	12	14	13	11	14	12	11	14	12	11	11	11	11	11	11	10	10	10	9
7	16	13	12	10	16	13	12	10	13	11	10	13	11	10	12	11	10	10	10	10	10	10	9	9	9	8
8	15	12	10	9	15	12	10	9	12	10	9	12	10	9	11	10	9	9	9	9	9	9	8	8	8	7
9	14	11	10	8	14	11	9	8	11	9	8	11	9	8	10	9	8	8	8	8	8	8	7	7	7	6
10	13	10	9	8	13	10	9	8	10	9	7	10	8	7	10	8	7	7	7	7	7	7	6	6	6	5





# P87AT

## P87AT WITH P8066-31

Report No. 98125

No. Lamps: 1 Type Lamp: 75PAR30L/FL - GE Total Lumens: 1000

Fixture Efficiency: 87.2%

S/MH Ratio: 1.0

### Single Fixture Data

Ceiling Ht.(Ft.)	10% Values		Zero Degrees Ft.-C	50% Values	
	Beam Angle - 88			Beam Angle - 54	
	Ft.-C	Beam Dia.		Ft.-C	Beam Dia.
8	2.2	11	22.2	11.1	6
10	1.2	14	11.9	6.0	8
12	0.7	18	7.4	3.7	10
14	0.5	22	5.1	2.5	12
16	0.4	26	3.7	1.8	14

Ft.-C (Footcandles) are initial and measured 2'-6" from floor

### Quick Calculator Charts

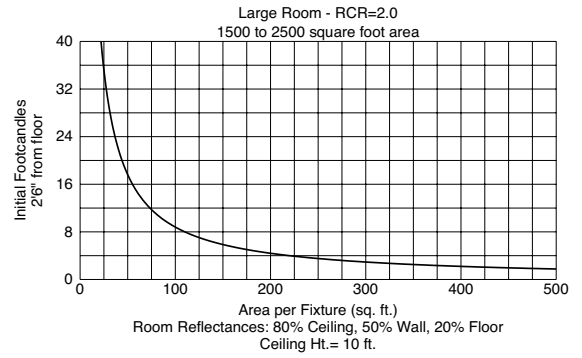
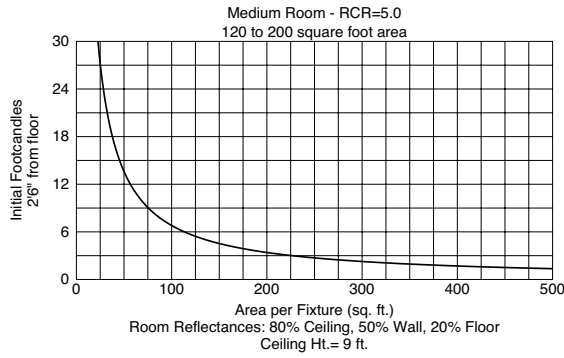

#### DISTRIBUTION CURVE

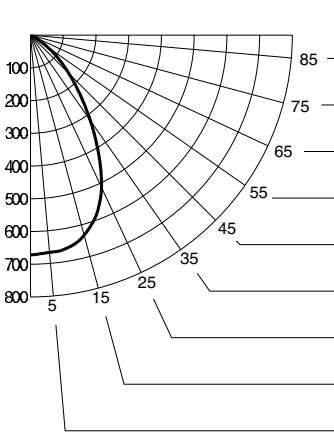

#### INTENSITY DATA

DEGREES	CANDELA
90	0
85	0
80	1
75	1
70	4
65	10
60	26
55	63
50	111
45	166
40	234
35	319
30	415
25	513
20	586
15	633
10	659
5	667
0	672

#### ZONAL CAVITY COEFFICIENTS OF UTILIZATION

Effective Floor Cavity Reflectance 0.20

RC	70												50				30				10				0			
	80	50	30	10	70	50	30	10	50	30	10	50	30	10	50	30	10	50	30	10	50	30	10	0				
0	104	104	104	104	102	102	102	102	97	97	97	93	93	93	89	89	89	87	87	87	87	87	87	87				
1	98	96	93	91	96	94	92	90	90	88	87	87	85	84	84	83	82	80	80	80	80	80	80	80				
2	93	88	84	80	91	86	82	79	83	80	78	81	78	76	78	76	74	73	73	73	73	73	73	73				
3	87	80	75	71	85	79	75	71	77	73	70	75	71	69	73	70	68	66	66	66	66	66	66	66				
4	82	74	68	64	80	73	68	64	71	66	63	69	65	62	67	64	61	60	60	60	60	60	60	60				
5	77	68	62	58	75	67	62	58	66	61	57	64	60	57	63	59	56	55	55	55	55	55	55	55				
6	72	63	57	53	71	62	57	53	61	56	52	60	55	52	58	55	51	50	50	50	50	50	50	50				
7	68	59	53	48	67	58	52	48	57	52	48	56	51	48	55	50	47	46	46	46	46	46	46	46				
8	64	54	49	44	63	54	48	44	53	48	44	52	47	44	51	47	44	42	42	42	42	42	42	42				
9	60	51	45	41	59	50	45	41	50	44	41	49	44	41	48	44	41	39	39	39	39	39	39	39				
10	57	48	42	38	56	47	42	38	46	41	38	46	41	38	45	41	38	36	36	36	36	36	36	36				