

WIREMOLD® OmniBox Series Floor Boxes

Fully Adjustable, Multiple Service, Floor Boxes



Protection from
water, dirt, and
debris.

OmniBox™ Series Floor Boxes provides an excellent activation solution when multiple services are required in open space areas. OmniBox™ Series Floor Boxes offer one-, two-, and three-gang multi-service boxes that are fully adjustable before and after the concrete pour.

Available in both stamped steel and cast iron fabrications, they meet a wide range of workstation requirements for today's and tomorrow's service needs. These floor boxes have many applications, some of which include schools, financial institutions, and commercial office buildings.

Two-gang OmniBox Series Floor Box Installation with an aesthetically pleasing flush activation cover.



FEATURES & BENEFITS

- **Fully adjustable box.** Fully adjustable both before and after concrete pour. Reduces installation costs.
- **Two Fabrications: Stamped Steel** – Lower cost concrete-tight construction option for above grade applications. **Cast-Iron** – Watertight construction for on or below grade applications.
- **Available in two depths.** Economical alternatives when pour depths are limited.
- **Flush activation assemblies for carpet and tile.** Aesthetically pleasing assemblies are interchangeable in both cast-iron and stamped steel box models.
- **Available in one-, two-, and three-gang configurations.** Removable dividers increase capacity. More configurations to support multi-service applications.
- **Triple service boxes.** Accommodates power, communication and/or audio/video devices which reduces the need for multiple boxes.
- **Brushed aluminum covers for power applications.** 830CK Series Aluminum Covers redesigned to accept threaded conduit when passing through power cables.
- **Brass and brushed aluminum covers accept single locking power receptacles.** New 828DLR Series provides single flip lid cover.
- **BAA Aluminum Covers.** Rectangular aluminum covers are now available in a version that complies with the Buy America Act and ARRA requirements. Covers are available in five powder coat finishes (black, gray, bronze, brass and nickel).
- **828COMTC Series Cover Kit in brass and brushed aluminum.** Allows communication devices to be recessed into 880S and 880CS Series Floor Boxes.
- **Partition support kit for 3-gang tile flanges.** The 838TAL-880 Series Flanges provide partition supports in tile applications for added strength and durability.
- **TopGuard protection.** All cover assemblies for the OmniBox Floor Box Series have TopGuard protection. An integral design which keeps out water, dirt, and debris from the power and communication compartments.
- **Boxes and covers have been listed by Underwriters Laboratories Inc. to their standard UL514A, 514C, 514D, and Canadian standard C22.2**
- **Datacom connectivity options.** Accepts industry standard and proprietary devices from a wide range of manufacturers to provide a seamless and aesthetically pleasing interface for voice, data, audio, and video applications at the point-of-use. A wide selection of data and adapter options available for use with Ortronics® TracJack® and Series II devices.



PEP
eco
PASS
PORT®

Download this product's PEP ecopassport® environmental product declaration at www.legrand.us/resources-and-downloads. This declaration conforms with ISO 14025 and 14040 and is in alignment with EN 15804.

OmniBox Series Stamped Steel Floor Boxes Ordering Information

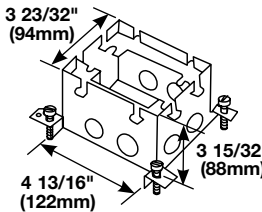
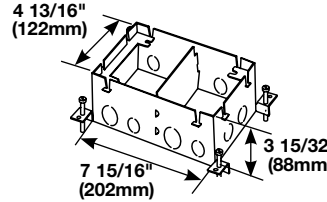
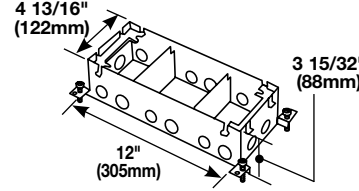
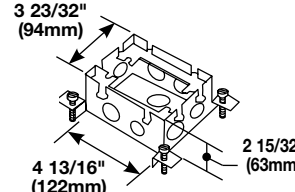
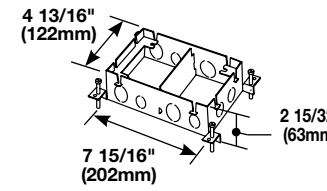
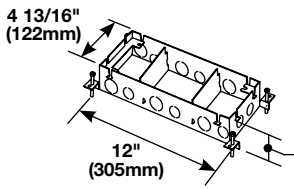
Catalog No./Item	Description/Specifications												
<p>880S1</p> 	<p>One-Gang Stamped Steel Floor Box – Fully Adjustable.</p> <table border="1" style="width: 100%; border-collapse: collapse;"> <thead> <tr> <th colspan="4" style="background-color: #333; color: white;">TECHNICAL SPECIFICATIONS</th> </tr> <tr> <th style="width: 50%;">Conduit Openings</th> <th style="width: 15%;">Cubic Inch Capacity</th> <th style="width: 15%;">Adjustment Before Pour</th> <th style="width: 20%;">Adjustment After Pour</th> </tr> </thead> <tbody> <tr> <td>(3) 1/2" (12.7mm), (5) 3/4" (19.1mm) (2) 1" (25mm)</td> <td style="text-align: center;">53</td> <td style="text-align: center;">1 3/4" (44mm)</td> <td style="text-align: center;">1/2" (12.7mm)</td> </tr> </tbody> </table> <p>Country of Origin: Mexico</p>	TECHNICAL SPECIFICATIONS				Conduit Openings	Cubic Inch Capacity	Adjustment Before Pour	Adjustment After Pour	(3) 1/2" (12.7mm), (5) 3/4" (19.1mm) (2) 1" (25mm)	53	1 3/4" (44mm)	1/2" (12.7mm)
TECHNICAL SPECIFICATIONS													
Conduit Openings	Cubic Inch Capacity	Adjustment Before Pour	Adjustment After Pour										
(3) 1/2" (12.7mm), (5) 3/4" (19.1mm) (2) 1" (25mm)	53	1 3/4" (44mm)	1/2" (12.7mm)										
<p>880S2</p> 	<p>Two-Gang Stamped Steel Floor Box – Fully Adjustable.</p> <table border="1" style="width: 100%; border-collapse: collapse;"> <thead> <tr> <th colspan="4" style="background-color: #333; color: white;">TECHNICAL SPECIFICATIONS</th> </tr> <tr> <th style="width: 50%;">Conduit Openings</th> <th style="width: 15%;">Cubic Inch Capacity</th> <th style="width: 15%;">Adjustment Before Pour</th> <th style="width: 20%;">Adjustment After Pour</th> </tr> </thead> <tbody> <tr> <td>(4) 1/2" (12.7mm), (8) 3/4" (19.1mm) (4) 1" (25mm)</td> <td style="text-align: center;">117 (58/59)</td> <td style="text-align: center;">1 3/4" (44mm)</td> <td style="text-align: center;">1/2" (12.7mm)</td> </tr> </tbody> </table> <p>Country of Origin: Mexico</p>	TECHNICAL SPECIFICATIONS				Conduit Openings	Cubic Inch Capacity	Adjustment Before Pour	Adjustment After Pour	(4) 1/2" (12.7mm), (8) 3/4" (19.1mm) (4) 1" (25mm)	117 (58/59)	1 3/4" (44mm)	1/2" (12.7mm)
TECHNICAL SPECIFICATIONS													
Conduit Openings	Cubic Inch Capacity	Adjustment Before Pour	Adjustment After Pour										
(4) 1/2" (12.7mm), (8) 3/4" (19.1mm) (4) 1" (25mm)	117 (58/59)	1 3/4" (44mm)	1/2" (12.7mm)										
<p>880S3</p> 	<p>Three-Gang Stamped Steel Floor Box – Fully Adjustable.</p> <table border="1" style="width: 100%; border-collapse: collapse;"> <thead> <tr> <th colspan="4" style="background-color: #333; color: white;">TECHNICAL SPECIFICATIONS</th> </tr> <tr> <th style="width: 50%;">Conduit Openings</th> <th style="width: 15%;">Cubic Inch Capacity</th> <th style="width: 15%;">Adjustment Before Pour</th> <th style="width: 20%;">Adjustment After Pour</th> </tr> </thead> <tbody> <tr> <td>(5) 1/2" (12.7mm), (11) 3/4" (19.1mm) (6) 1" (25mm)</td> <td style="text-align: center;">180 (56/68/56)</td> <td style="text-align: center;">1 3/4" (44mm)</td> <td style="text-align: center;">1/2" (12.7mm)</td> </tr> </tbody> </table> <p>Country of Origin: Mexico</p>	TECHNICAL SPECIFICATIONS				Conduit Openings	Cubic Inch Capacity	Adjustment Before Pour	Adjustment After Pour	(5) 1/2" (12.7mm), (11) 3/4" (19.1mm) (6) 1" (25mm)	180 (56/68/56)	1 3/4" (44mm)	1/2" (12.7mm)
TECHNICAL SPECIFICATIONS													
Conduit Openings	Cubic Inch Capacity	Adjustment Before Pour	Adjustment After Pour										
(5) 1/2" (12.7mm), (11) 3/4" (19.1mm) (6) 1" (25mm)	180 (56/68/56)	1 3/4" (44mm)	1/2" (12.7mm)										
<p>880M1</p> 	<p>One-Gang Shallow Stamped Steel Floor Box – Fully Adjustable.</p> <table border="1" style="width: 100%; border-collapse: collapse;"> <thead> <tr> <th colspan="4" style="background-color: #333; color: white;">TECHNICAL SPECIFICATIONS</th> </tr> <tr> <th style="width: 50%;">Conduit Openings</th> <th style="width: 15%;">Cubic Inch Capacity</th> <th style="width: 15%;">Adjustment Before Pour</th> <th style="width: 20%;">Adjustment After Pour</th> </tr> </thead> <tbody> <tr> <td>(5) 1/2" (12.7mm), (5) 3/4" (19.1mm)</td> <td style="text-align: center;">37</td> <td style="text-align: center;">1 3/4" (44mm)</td> <td style="text-align: center;">1/2" (12.7mm)</td> </tr> </tbody> </table> <p>Country of Origin: Mexico</p>	TECHNICAL SPECIFICATIONS				Conduit Openings	Cubic Inch Capacity	Adjustment Before Pour	Adjustment After Pour	(5) 1/2" (12.7mm), (5) 3/4" (19.1mm)	37	1 3/4" (44mm)	1/2" (12.7mm)
TECHNICAL SPECIFICATIONS													
Conduit Openings	Cubic Inch Capacity	Adjustment Before Pour	Adjustment After Pour										
(5) 1/2" (12.7mm), (5) 3/4" (19.1mm)	37	1 3/4" (44mm)	1/2" (12.7mm)										
<p>880M2</p> 	<p>Two-Gang Shallow Stamped Steel Floor Box – Fully Adjustable.</p> <table border="1" style="width: 100%; border-collapse: collapse;"> <thead> <tr> <th colspan="4" style="background-color: #333; color: white;">TECHNICAL SPECIFICATIONS</th> </tr> <tr> <th style="width: 50%;">Conduit Openings</th> <th style="width: 15%;">Cubic Inch Capacity</th> <th style="width: 15%;">Adjustment Before Pour</th> <th style="width: 20%;">Adjustment After Pour</th> </tr> </thead> <tbody> <tr> <td>(8) 1/2" (12.7mm), (8) 3/4" (19.1mm)</td> <td style="text-align: center;">80 40/40</td> <td style="text-align: center;">1 3/4" (44mm)</td> <td style="text-align: center;">1/2" (12.7mm)</td> </tr> </tbody> </table> <p>Country of Origin: Mexico</p>	TECHNICAL SPECIFICATIONS				Conduit Openings	Cubic Inch Capacity	Adjustment Before Pour	Adjustment After Pour	(8) 1/2" (12.7mm), (8) 3/4" (19.1mm)	80 40/40	1 3/4" (44mm)	1/2" (12.7mm)
TECHNICAL SPECIFICATIONS													
Conduit Openings	Cubic Inch Capacity	Adjustment Before Pour	Adjustment After Pour										
(8) 1/2" (12.7mm), (8) 3/4" (19.1mm)	80 40/40	1 3/4" (44mm)	1/2" (12.7mm)										
<p>880M3</p> 	<p>Three-Gang Shallow Stamped Steel Floor Box – Fully Adjustable.</p> <table border="1" style="width: 100%; border-collapse: collapse;"> <thead> <tr> <th colspan="4" style="background-color: #333; color: white;">TECHNICAL SPECIFICATIONS</th> </tr> <tr> <th style="width: 50%;">Conduit Openings</th> <th style="width: 15%;">Cubic Inch Capacity</th> <th style="width: 15%;">Adjustment Before Pour</th> <th style="width: 20%;">Adjustment After Pour</th> </tr> </thead> <tbody> <tr> <td>(11) 1/2" (12.7mm), (11) 3/4" (19.1mm)</td> <td style="text-align: center;">126 39/48/39</td> <td style="text-align: center;">1 3/4" (44mm)</td> <td style="text-align: center;">1/2" (12.7mm)</td> </tr> </tbody> </table> <p>Country of Origin: Mexico</p>	TECHNICAL SPECIFICATIONS				Conduit Openings	Cubic Inch Capacity	Adjustment Before Pour	Adjustment After Pour	(11) 1/2" (12.7mm), (11) 3/4" (19.1mm)	126 39/48/39	1 3/4" (44mm)	1/2" (12.7mm)
TECHNICAL SPECIFICATIONS													
Conduit Openings	Cubic Inch Capacity	Adjustment Before Pour	Adjustment After Pour										
(11) 1/2" (12.7mm), (11) 3/4" (19.1mm)	126 39/48/39	1 3/4" (44mm)	1/2" (12.7mm)										

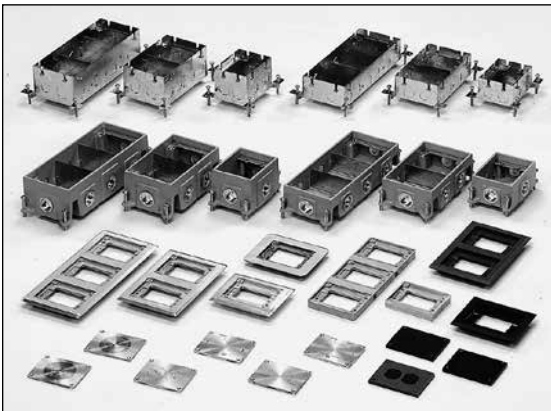

OmniBox Series Floor Boxes are available in a full range of box sizes, depths, and capacities with activation covers that enhance any decor and provide a full range of connectivity options.

OmniBox Series Cast Iron Floor Boxes Ordering Information

Catalog No./Item

Description/Specifications

880CS1-1

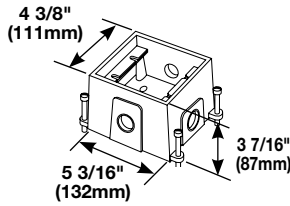

One-Gang Cast Iron Floor Box – Fully Adjustable.

TECHNICAL SPECIFICATIONS			
Conduit Openings	Cubic Inch Capacity	Adjustment Before Pour	Adjustment After Pour
(4) 1" (25mm)	48	1 3/4" (44mm)	1/2" (12.7mm)

Country of Origin: China

880CS2-1

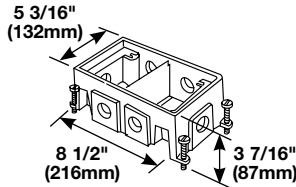

Two-Gang Cast Iron Floor Box – Fully Adjustable.

TECHNICAL SPECIFICATIONS			
Conduit Openings	Cubic Inch Capacity	Adjustment Before Pour	Adjustment After Pour
(6) 1" (25mm)	94 (45/49)	1 3/4" (44mm)	1/2" (12.7mm)

Country of Origin: China

880CS3-1

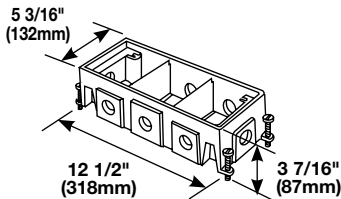

Three-Gang Cast Iron Floor Box – Fully Adjustable.

TECHNICAL SPECIFICATIONS			
Conduit Openings	Cubic Inch Capacity	Adjustment Before Pour	Adjustment After Pour
(8) 1" (25mm)	160 (53/54/53)	1 3/4" (44mm)	1/2" (12.7mm)

Country of Origin: China

880CS1-NA

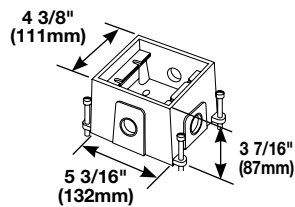

North America Made One-Gang Cast Iron Floor Box – Fully Adjustable.

Conduit Openings	Cubic Inch Capacity	Adjustment Before Pour	Adjustment After Pour
(4) 1" (25mm)	48	1 3/4" (44mm)	1/2" (12.7mm)

Country of Origin: USA

880CS2-NA

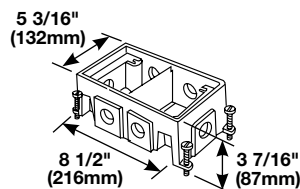

North America Made Two-Gang Cast Iron Floor Box – Fully Adjustable.

TECHNICAL SPECIFICATIONS			
Conduit Openings	Cubic Inch Capacity	Adjustment Before Pour	Adjustment After Pour
(6) 1" (25mm)	94 (45/49)	1 3/4" (44mm)	1/2" (12.7mm)

Country of Origin: USA

880CS3-NA

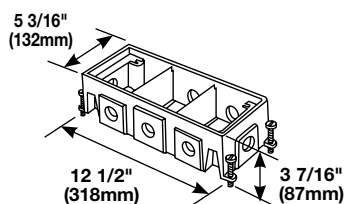

North America Made Three-Gang Cast Iron Floor Box – Fully Adjustable.

TECHNICAL SPECIFICATIONS			
Conduit Openings	Cubic Inch Capacity	Adjustment Before Pour	Adjustment After Pour
(8) 1" (25mm)	160 (53/54/53)	1 3/4" (44mm)	1/2" (12.7mm)

Country of Origin: USA



Single-gang stamped steel and triple-gang cast iron models of OmniBox Series Floor Boxes.

OmniBox Series Cast Iron Floor Boxes Ordering Information (continued)

Catalog No./Item

Description/Specifications

880CM1-1

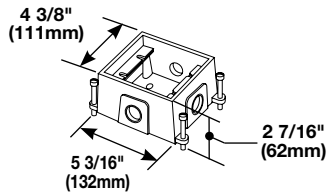

One-Gang Shallow Cast Iron Floor Box – Fully Adjustable.

TECHNICAL SPECIFICATIONS

Conduit Openings	Cubic Inch Capacity	Adjustment Before Pour	Adjustment After Pour
(4) 1" (25mm),	34	1 3/4" (44mm)	1/2" (12.7mm)

Country of Origin: USA

880CM2-1

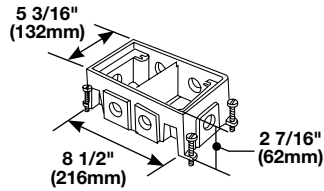

Two-Gang Shallow Cast Iron Floor Box – Fully Adjustable.

TECHNICAL SPECIFICATIONS

Conduit Openings	Cubic Inch Capacity	Adjustment Before Pour	Adjustment After Pour
(6) 1" (25mm),	76 36/40	1 3/4" (44mm)	1/2" (12.7mm)

Country of Origin: USA

880CM3-1

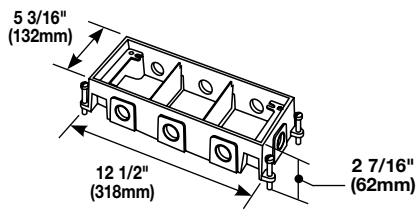

Three-Gang Shallow Cast Iron Floor Box – Fully Adjustable.

TECHNICAL SPECIFICATIONS

Conduit Openings	Cubic Inch Capacity	Adjustment Before Pour	Adjustment After Pour
(8) 1" (25mm),	118 39/40/39	1 3/4" (44mm)	1/2" (12.7mm)

Country of Origin: USA

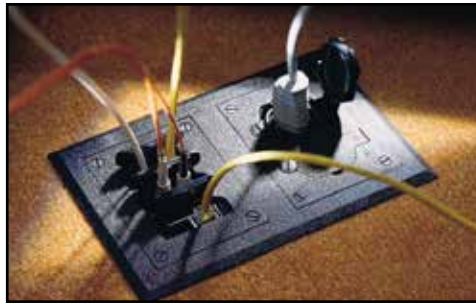

Cover Plates for OmniBox Series Floor Boxes provide access to a wide range of connectivity and are available in both metal and nonmetallic fabrications.

OmniBox Series Floor Boxes Solid Brass Cover Plate Flanges Ordering Information

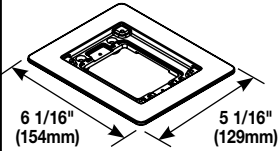
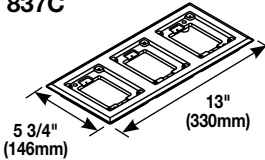
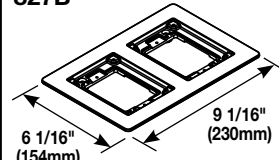
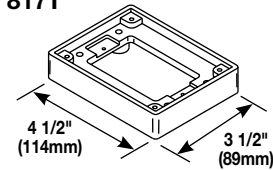
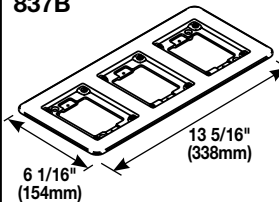
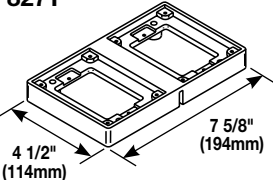
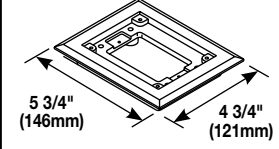
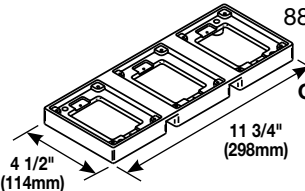
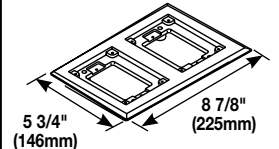
Catalog No./Item	Description/Specifications	Catalog No./Item	Description/Specifications
817B 	One-Gang Brass Combination Carpet & Tile Flange – Accepts Ortronics® MAB6TJ TracJack and MAB3S2 Series II adapters and Wiremold CM Series inserts, sold separately. Country of Origin: China	837C 	Three-Gang Brass Carpet Flange – For use on 880S3, 880M3, 880CS32-1, and 880CM3-1 Floor Boxes. Country of Origin: China
827B 	Two-Gang Brass Combination Carpet and Tile Flange – Accepts Ortronics® MAB6TJ TracJack and MAB3S2 Series II adapters and Wiremold CM Series inserts, sold separately. Country of Origin: China	817T 	One-Gang Brass Tile Flange – For use on 880S1, 880M1, 880CS1-1, and 880M1-1 Floor Boxes. Country of Origin: China
837B 	Three-Gang Brass Combination Carpet and Tile Flange – Accepts Ortronics® MAB6TJ TracJack and MAB3S2 Series II adapters and Wiremold CM Series inserts, sold separately. Country of Origin: China	827T 	Two-Gang Brass Tile Flange – For use on 880S2, 880M2, 880CS2-1, and 880CM2-1 Floor Boxes. Country of Origin: China
817C 	One-Gang Brass Carpet Flange – For use on 880S1, 880M1, 880CS1-1, and 880CM1-1 Floor Boxes. Country of Origin: China	837T 	Three-Gang Brass or Brushed Aluminum Tile Flange – For use on 880S3, 880M3, 880CS3-1, and 880CM3-1 Floor Boxes. Country of Origin: China
827C 	Two-Gang Brass Carpet Flange – For use on 880S2, 880M2, 880CS2-1, and 880CM2-1 Floor Boxes. Country of Origin: China		

NOTE: UL Listed for tile, terrazzo, and carpet floors.

Brass covers and flanges are not interchangeable with aluminum or nonmetallic covers and flanges. Nonmetallic covers are interchangeable with aluminum flanges.

All cover assemblies for the OmniBox Floor Box Series have TopGuard protection.

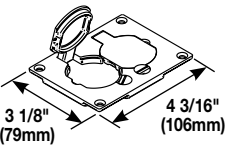
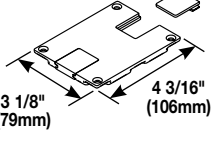
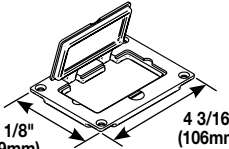
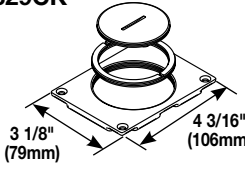
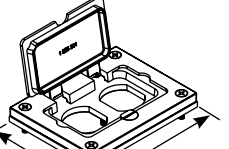
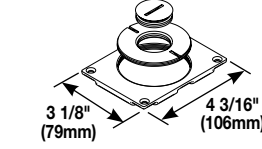
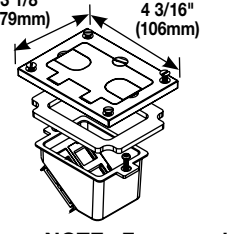
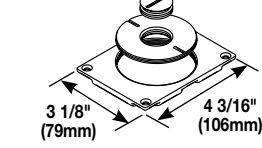
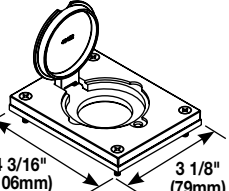
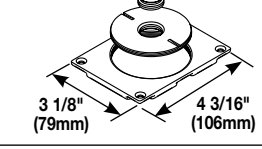
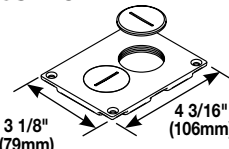
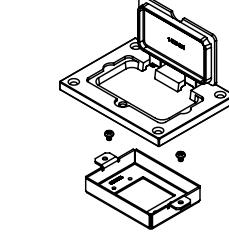

OmniBox Series Floor Boxes Metal Cover Plates Ordering Information

Catalog No./Item	Description/Specifications	Catalog No./Item	Description/Specifications
828R 	Brass Duplex Cover Plate – Flip lids. Can also be used with a 106 type communication adapter. Country of Origin: China	829STC 	Brass Communication Cover Plate – Data slides. Feed through only, not for use with a mounting plate for communication jacks. Country of Origin: China
828GFITC 	Brass GFI Cover Plate – May be used with Activate and Ortronics® Connectivity Systems in conjunction with 817B, 827B, and 837B Flanges. Country of Origin: China	829CK 	Brass Communication Cover Plate – 2 5/8" and 2 1/4" (67mm and 57mm) plugs. Country of Origin: China
828DPGFITC 	Brass Rectangular Cover Plate – Allows for mounting of a duplex style receptacle with a rectangular style flip lid cover. Country of Origin: China	829CK-1 	Brass Communication Cover Plate – 2 5/8" and 1" (67mm and 25mm) plugs. Country of Origin: China
828COMTC 	Brass Communication Cover Plate – Allows for up to four communication devices to be mounted in a recessed position within the 880 Floor Box. The 828COM Cover Plate has removable slides for cable egress. Country of Origin: China	829CK-3/4 	Brass Communication Cover Plate – 2 5/8" and 3/4" (67mm and 19.1mm) plugs. Country of Origin: China
828DLR 	Brass Single Locking Receptacle Cover Plate – Single flip lid cover for 20A or 30A single locking receptacles. Device opening is 2 5/8" (67mm). For use with maximum female locking device of 1.58" diameter, and maximum male plug face of 2.25" diameter Country of Origin: China	829CK-1/2 	Brass Communication Cover Plate – 2 5/8" and 1/2" (67mm and 12.7mm) plugs. Country of Origin: China
828SPTC 	Brass Duplex Cover Plate – Screw plugs. Screw plugs are 1 1/2" (38mm) in diameter. Country of Origin: China	828MAAP 	A/V Adapter Plate – Sheet metal adapter plate that accepts two (2) Extron- Electronics MAAP style device plates (sold separately). For use with 828GFITC or 828GFITCAL cover plates. (Sold separately) Country of Origin: USA

NOTE: Brass covers and flanges are not interchangeable with aluminum or nonmetallic covers and flanges. Nonmetallic covers are interchangeable with aluminum flanges.

All cover assemblies for the OmniBox Floor Box Series have TopGuard protection.

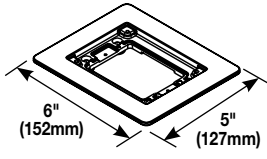
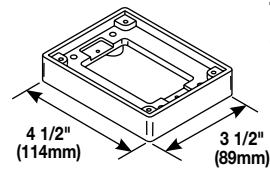
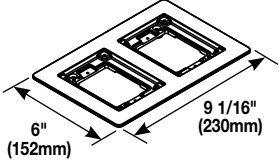
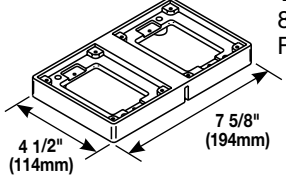
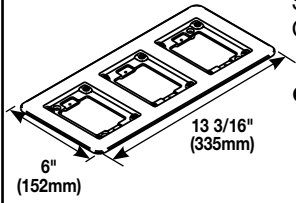
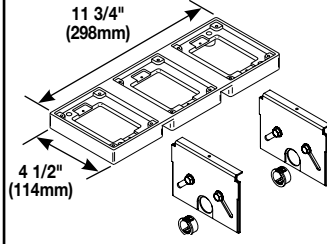

OmniBox Series Floor Boxes Brushed Aluminum Cover Plate Flanges Ordering Information

Catalog No./Item	Description/Specifications
<p>818TCAL</p>  <p style="text-align: center;">Country of Origin: China</p> <p>NOTE: Brushed aluminum flanges come with beveled edges.</p>	<p>818TAL</p>  <p style="text-align: center;">Country of Origin: China</p>
<p>828TCAL</p>  <p style="text-align: center;">Country of Origin: China</p> <p>NOTE: Brushed aluminum flanges come with beveled edges.</p>	<p>828TAL</p>  <p style="text-align: center;">Country of Origin: China</p>
<p>838TCAL</p>  <p style="text-align: center;">Country of Origin: China</p> <p>NOTE: Brushed aluminum flanges come with beveled edges.</p>	<p>838TAL-880S3 838TAL-880M3 838TAL-880CS3 838TAL-880CM3</p>  <p style="text-align: center;">Country of Origin: USA</p> <p>NOTE: Order kit for specific box type: 880S3, 880M3, 880CS3, or 880CM3.</p>

NOTE: UL Listed for tile, terrazzo, and carpet floors.

Brass covers and flanges are not interchangeable with aluminum or nonmetallic covers and flanges. Nonmetallic covers are interchangeable with aluminum flanges.

All cover assemblies for the OmniBox Floor Box Series have TopGuard protection.

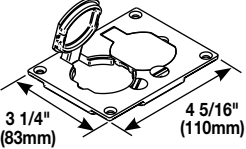
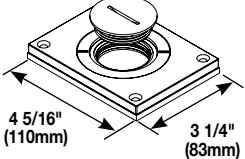
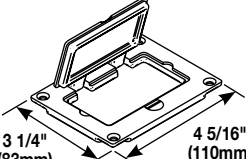
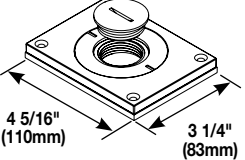
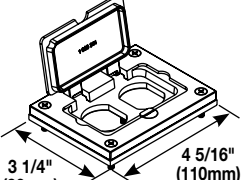
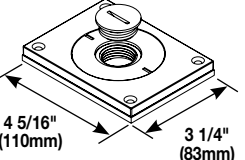
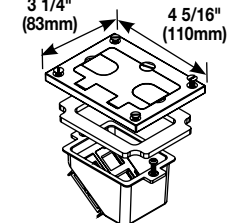
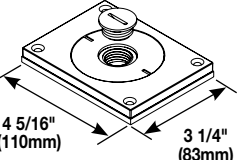
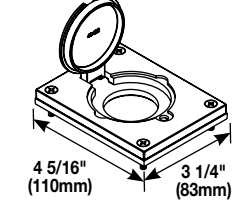
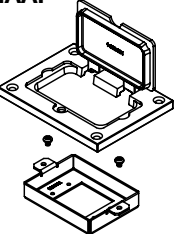

OmniBox Series Floor Boxes Metal Cover Plates Ordering Information

Catalog No./Item	Description/Specifications	Catalog No./Item	Description/Specifications
828R-TCAL 	Brushed Aluminum Duplex Cover Plate – Flip lids. Can also be used with a 106 type communication adapter. Country of Origin: China	830KTCAL 	Brushed Aluminum Cover Plate – Power or communication plate with 2" (51mm) and 1 1/4" (32mm) plugs. Country of Origin: China NOTE: Acceptable for use with threaded conduit when passing through power cables.
828GFITCAL 	Brushed Aluminum GFI Cover Plate – May be used with Activate and Ortronics® Connectivity Systems in conjunction with 817B, 827B, and 837B Flanges. Country of Origin: China	830KTCAL-1 	Brushed Aluminum Cover Plate – Power or communication plate with 2" (51mm) and 1" (25mm) plugs. Country of Origin: China NOTE: Acceptable for use with threaded conduit when passing through power cables.
828DPGFITCAL 	Brushed Aluminum Rectangular Cover Plate – Allows for mounting of a duplex style receptacle with a rectangular style flip lid cover. Country of Origin: China	830KTCAL-3/4 	Brushed Aluminum Cover Plate – Power or communication plate with 2" (51mm) and 3/4" (19.1mm) plugs. Country of Origin: China NOTE: Acceptable for use with threaded conduit when passing through power cables.
828COMTCAL 	Brushed Aluminum Communication Cover Plate – Allows for up to four communication devices to be mounted in a recessed position within the 880 Floor Box. The 828COMTCAL Cover Plate has removable slides for cable egress. Country of Origin: China NOTE: For use with 880S and 880CS Series Boxes only.	830KTCAL-1/2 	Brushed Aluminum Cover Plate – Power or communication plate with 2" (51mm) and 1/2" (12.7mm) plugs. Country of Origin: China NOTE: Acceptable for use with threaded conduit when passing through power cables.
828DLRAL 	Brushed Aluminum Single Locking Receptacle Cover Plate – Single flip lid cover for 20A or 30A single locking receptacles. Device opening is 2 5/8" (67mm). For use with maximum female locking device of 1.58" diameter, and maximum male plug face of 2.25" diameter Country of Origin: China	828MAAP 	A/V Adapter Plate – Sheet metal adapter plate that accepts two (2) Extron® Electronics MAAP style device plates (sold separately). For use with 828GFITC or 828GFITCAL cover plates. (Sold separately) Country of Origin: USA

NOTE: Brass covers and flanges are not interchangeable with aluminum or nonmetallic covers and flanges. Nonmetallic covers are interchangeable with aluminum flanges.

All cover assemblies for the OmniBox Floor Box Series have TopGuard protection.

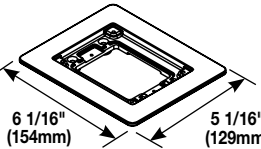
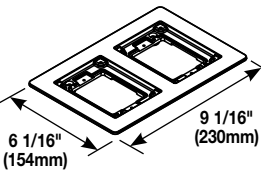
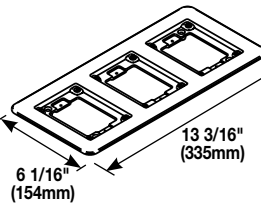
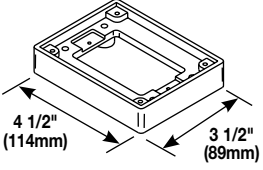
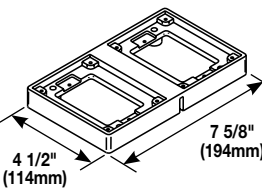
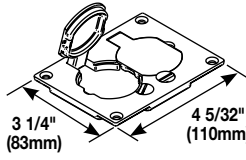
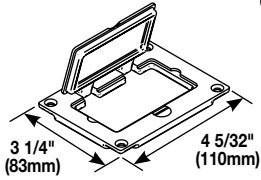
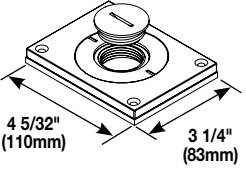

OmniBox Series Floor Boxes Powder-Coated Aluminum Cover Plate Flanges Ordering Information

Catalog No./Item	Description/Specifications
<p>817TCAL-BK 817TCAL-GY 817TCAL-BS 817TCAL-NK 817TCAL-BZ</p>  <p style="text-align: center;">6 1/16" (154mm) 5 1/16" (129mm)</p>	<p>One-Gang Powder-Coated Aluminum Combination Carpet and Tile Flange – Accepts Ortronics® MAB6TJ TracJack and MAB3S2 Series II adapters and Wiremold CM Series inserts, sold separately. Flanges are available in five decorative colors: black, gray brass, nickel and bronze.</p> <p>Country of Origin: USA</p>
<p>827TCAL-BK 827TCAL-GY 827TCAL-BS 827TCAL-NK 827TCAL-BZ</p>  <p style="text-align: center;">6 1/16" (154mm) 9 1/16" (230mm)</p>	<p>Two-Gang Powder-Coated Aluminum Combination Carpet and Tile Flange – Accepts Ortronics® MAB6TJ TracJack and MAB3S2 Series II adapters and Wiremold CM Series inserts, sold separately. Flanges are available in five decorative colors: black, gray brass, nickel and bronze.</p> <p>Country of Origin: USA</p>
<p>837TCAL-BK 837TCAL-GY 837TCAL-BS 837TCAL-NK 837TCAL-BZ</p>  <p style="text-align: center;">6 1/16" (154mm) 13 3/16" (335mm)</p>	<p>Three-Gang Powder-Coated Aluminum Combination Carpet and Tile Flange – Accepts Ortronics® MAB6TJ TracJack and MAB3S2 Series II adapters and Wiremold CM Series inserts, sold separately. Flanges are available in five decorative colors: black, gray brass, nickel and bronze.</p> <p>Country of Origin: USA</p>
<p>817TAL-BK 817TAL-GY 817TAL-BS 817TAL-NK 817TAL-BZ</p>  <p style="text-align: center;">4 1/2" (114mm) 3 1/2" (89mm)</p>	<p>One-Gang Powder-Coated Aluminum Tile Flange – For use on 880S1, 880M1, 880CS1-1, and 880M1-1 Floor Boxes. Flanges are available in five decorative colors: black, gray brass, nickel and bronze.</p> <p>Country of Origin: USA</p>
<p>827TAL-BK 827TAL-GY 827TAL-BS 827TAL-NK 827TAL-BZ</p>  <p style="text-align: center;">4 1/2" (114mm) 7 5/8" (194mm)</p>	<p>Two-Gang Powder-Coated Aluminum Tile Flange – For use on 880S2, 880M2, 880CS2-1, and 880CM2-1 Floor Boxes. Flanges are available in five decorative colors: black, gray brass, nickel and bronze.</p> <p>Country of Origin: USA</p>
<p>828R-TCALBK 828R-TCALGY 828R-TCALBS 828R-TCALNK 828R-TCALBZ</p>  <p style="text-align: center;">3 1/4" (83mm) 4 5/32" (110mm)</p>	<p>Powder-Coated Aluminum Duplex Cover Plate – Flip lids. Can also be used with a 106 type communication adapter.</p> <p>Country of Origin: USA</p>
<p>828GFITCAL-BK 828GFITCAL-GY 828GFITCAL-BS 828GFITCAL-NK 828GFITCAL-BZ</p>  <p style="text-align: center;">3 1/4" (83mm) 4 5/32" (110mm)</p>	<p>Powder-Coated Aluminum Rectangular Cover Plate – Allows for mounting a duplex receptacle (Decorator or GFCI style) with a rectangular flip cover</p> <p>Country of Origin: USA</p>
<p>829CKAL-1BK 829CKAL-1GY 829CKAL-1BS 829CKAL-1NK 829CKAL-1BZ</p>  <p style="text-align: center;">4 5/32" (110mm) 3 1/4" (83mm)</p>	<p>Powder-Coated Aluminum Cover Plate – Power or communication plate with 2" (51mm) and 1" (25mm) plugs. Covers are available in five decorative colors: black, gray brass, nickel and bronze.</p> <p>Country of Origin: USA</p> <p>NOTE: Acceptable for use with threaded conduit when passing through power cables.</p>

NOTE: Pricing varies depending on country of origin. Consult your local sales representative for more information.

OmniBox Series Floor Boxes Powder-Coated Aluminum Cover Plate Flanges Ordering Information (Continued)

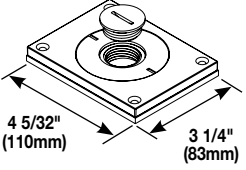
Catalog No./Item	Description/Specifications
<p>829CKAL-3/4BK 829CKAL-3/4GY 829CKAL-3/4BS 829CKAL-3/4NK 829CKAL-3/4BZ</p>  <p>4 5/32" (110mm)</p> <p>3 1/4" (83mm)</p>	<p>Powder-Coated Aluminum Cover Plate – Power or communication plate with 2" (51mm) and 3/4" (19.1mm) plugs. Covers are available in five decorative colors: black, gray brass, nickel and bronze.</p> <p>Country of Origin: USA</p> <p>NOTE: Acceptable for use with threaded conduit when passing through power cables.</p>

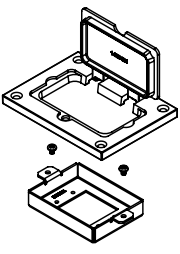
Catalog No./Item	Description/Specifications
<p>828MAAP</p> 	<p>A/V Adapter Plate – Sheet metal adapter plate that accepts two (2) Extron® Electronics MAAP style device plates (sold separately). For use with 828GFITC or 828GFITCAL cover plates. (Sold separately)</p> <p>Country of Origin: USA</p>

NOTE: UL Listed for tile, terrazzo, and carpet floors.

Brass covers and flanges are not interchangeable with aluminum or nonmetallic covers and flanges. Nonmetallic covers are interchangeable with aluminum flanges.

OmniBox Series Floor Boxes Nonmetallic Cover Plate Flanges Ordering Information

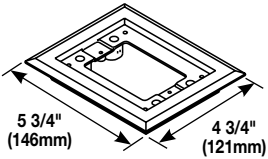
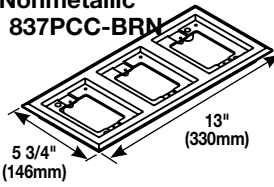
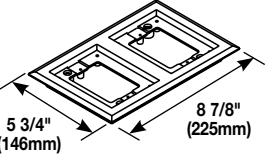
Catalog No./Item	Description/Specifications	Catalog No./Item	Description/Specifications
817PCC-BLK 817PCC-BRN	<p>One-Gang Nonmetallic Carpet Flange – Available in black or brown. For Ortronics® connectivity use with 829PFLRT Cover. For Activate connectivity use with 829PFL Cover. Accepts Ortronics® MAB6TJ TracJack and MAB3S2 Series II adapters and Wiremold CM Series inserts, sold separately.</p> <p style="text-align: right;">Country of Origin: Mexico</p>	Nonmetallic 837PCC-BRN	<p>Three-Gang Flange – Available in black or brown. For Ortronics® connectivity use with 829PFLRT Cover. For Activate connectivity use with 829PFL Cover. Accepts Ortronics® MAB6TJ TracJack and MAB3S2 Series II adapters and Wiremold CM Series inserts, sold separately.</p> <p style="text-align: right;">Country of Origin: Mexico</p>
			
827PCC-BLK 827PCC-BRN	<p>Two-Gang Nonmetallic Carpet Flange – Available in black or brown. For Ortronics® connectivity use with 829PFLRT Cover. For Activate connectivity use with 829PFL Cover. Accepts Ortronics® MAB6TJ TracJack and MAB3S2 Series II adapters and Wiremold CM Series inserts, sold separately.</p> <p style="text-align: right;">Country of Origin: Mexico</p>	<p>NOTE: UL Listed for tile, terrazzo, and carpet floors.</p> <p>Brass covers and flanges are not interchangeable with aluminum or nonmetallic covers and flanges. Nonmetallic covers are interchangeable with aluminum flanges.</p>	
			

OmniBox Series Floor Boxes Nonmetallic Cover Plates Ordering Information

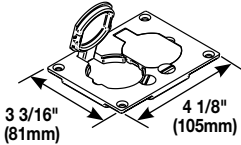
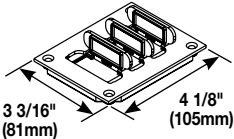
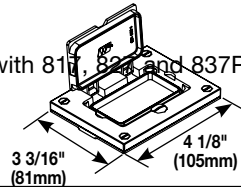
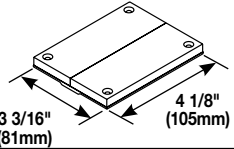
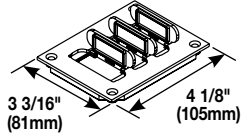
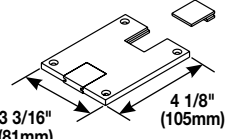
Catalog No./Item	Description/Specifications	Catalog No./Item	Description/Specifications
828PR-BLK 828PR-BRN	<p>Nonmetallic Duplex Cover Plate – Flip lids. Available in black or brown. Can also be used with a 106 type communication adapter.</p> <p style="text-align: right;">Country of Origin: USA</p>	829PFLRT-BLK 829PFLRT-BRN	<p>Nonmetallic Communication Cover Plate – Individual flip lids.* Available in black or brown. Gasket included. Ortronics® MAB6TJ TracJack and MAB3S2 Series II adapters included.</p> <p style="text-align: right;">Country of Origin: USA</p>
			
828PRGFI-BLK 828PRGFI-BRN	<p>Nonmetallic GFI Cover Plate – Available in black or brown. May be used with Ortronics® Connectivity systems in conjunction with 817PCC, 827PCC, and 837PCC Series flanges.</p> <p style="text-align: right;">Country of Origin: USA</p>	829PCK-BLK 829PCK-BRN	<p>Nonmetallic Communication Cover Plate – Breakouts. Available in black or brown. Feed through only, not for use with a mounting plate for communication jacks.</p> <p style="text-align: right;">Country of Origin: USA</p>
			
829PFL-BLK 829PFL-BRN	<p>Nonmetallic Communication Cover Plate – Individual flip lids.* Available in black or brown. Gasket included. Wiremold CM Series inserts included.</p> <p style="text-align: right;">Country of Origin: USA</p>	829PSTC-BLK 829PSTC-BRN	<p>Nonmetallic Communication Cover Plate – Data slides. Available in black or brown. Feed through only, not for use with a mounting plate for communication jacks.</p> <p style="text-align: right;">Country of Origin: USA</p>
			

*Replacement flip lids can be ordered under Cat. No. PFL-BLK and PFL-BRN. Each Cat. No. comes with three flip lids. The above cover plates are listed for tile, terrazzo, and carpet floors.

NOTE: Brass covers and flanges are not interchangeable with aluminum or nonmetallic covers and flanges. Nonmetallic covers are interchangeable with aluminum flanges.

NOTE: All brand and product names referenced in this document are registered trademarks or trademarks of their respective holders.



NOTE: The paper used to print this document is an environmentally responsible paper with 10% post consumer waste, with FSC and SFI Chain of Custody certifications, Lacey Act compliant. 100% of the electricity used to manufacture Flo sheets is generated with Green-e certified renewable energy.



Electrical Wiring Systems

60 Woodlawn Street
West Hartford, CT 06110
Phone: 1.877.BY.LEGRAND (295-3472)
www.legrand.us

570 Applewood Crescent
Vaughan, Ontario L4K 4B4
Phone: 905.738.9195
www.legrand.ca



WIREMOLD® OmniBox Series Floor Boxes

Fully Adjustable, Multiple Service, Floor Boxes



Protection from
water, dirt, and
debris.

OmniBox™ Series Floor Boxes provides an excellent activation solution when multiple services are required in open space areas. OmniBox™ Series Floor Boxes offer one-, two-, and three-gang multi-service boxes that are fully adjustable before and after the concrete pour.

Available in both stamped steel and cast iron fabrications, they meet a wide range of workstation requirements for today's and tomorrow's service needs. These floor boxes have many applications, some of which include schools, financial institutions, and commercial office buildings.

Two-gang OmniBox Series Floor Box Installation with an aesthetically pleasing flush activation cover.



FEATURES & BENEFITS

- **Fully adjustable box.** Fully adjustable both before and after concrete pour. Reduces installation costs.
- **Two Fabrications: Stamped Steel** – Lower cost concrete-tight construction option for above grade applications. **Cast-Iron** – Watertight construction for on or below grade applications.
- **Available in two depths.** Economical alternatives when pour depths are limited.
- **Flush activation assemblies for carpet and tile.** Aesthetically pleasing assemblies are interchangeable in both cast-iron and stamped steel box models.
- **Available in one-, two-, and three-gang configurations.** Removable dividers increase capacity. More configurations to support multi-service applications.
- **Triple service boxes.** Accommodates power, communication and/or audio/video devices which reduces the need for multiple boxes.
- **Brushed aluminum covers for power applications.** 830CK Series Aluminum Covers redesigned to accept threaded conduit when passing through power cables.
- **Brass and brushed aluminum covers accept single locking power receptacles.** New 828DLR Series provides single flip lid cover.
- **BAA Aluminum Covers.** Rectangular aluminum covers are now available in a version that complies with the Buy America Act and ARRA requirements. Covers are available in five powder coat finishes (black, gray, bronze, brass and nickel).
- **828COMTC Series Cover Kit in brass and brushed aluminum.** Allows communication devices to be recessed into 880S and 880CS Series Floor Boxes.
- **Partition support kit for 3-gang tile flanges.** The 838TAL-880 Series Flanges provide partition supports in tile applications for added strength and durability.
- **TopGuard protection.** All cover assemblies for the OmniBox Floor Box Series have TopGuard protection. An integral design which keeps out water, dirt, and debris from the power and communication compartments.
- **Boxes and covers have been listed by Underwriters Laboratories Inc. to their standard UL514A, 514C, 514D, and Canadian standard C22.2**
- **Datacom connectivity options.** Accepts industry standard and proprietary devices from a wide range of manufacturers to provide a seamless and aesthetically pleasing interface for voice, data, audio, and video applications at the point-of-use. A wide selection of data and adapter options available for use with Ortronics® TracJack® and Series II devices.



PEP
eco
PASS
PORT®

Download this product's PEP ecopassport® environmental product declaration at www.legrand.us/resources-and-downloads. This declaration conforms with ISO 14025 and 14040 and is in alignment with EN 15804.

OmniBox Series Stamped Steel Floor Boxes Ordering Information

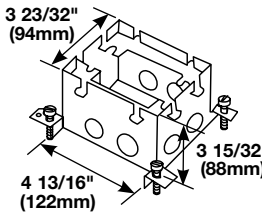
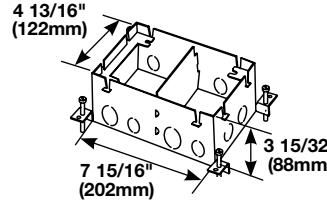
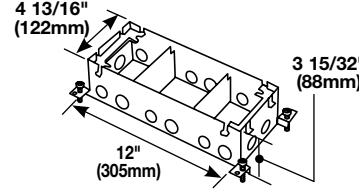
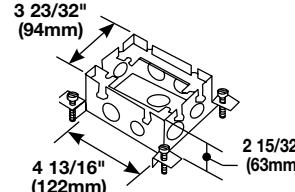
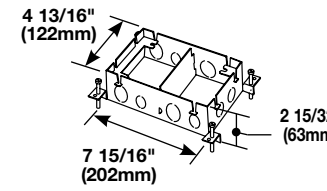
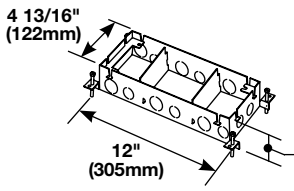
Catalog No./Item	Description/Specifications												
<p>880S1</p> 	<p>One-Gang Stamped Steel Floor Box – Fully Adjustable.</p> <table border="1" style="width: 100%; border-collapse: collapse;"> <thead> <tr> <th colspan="4" style="background-color: #333; color: white;">TECHNICAL SPECIFICATIONS</th> </tr> <tr> <th style="width: 40%;">Conduit Openings</th> <th style="width: 15%;">Cubic Inch Capacity</th> <th style="width: 15%;">Adjustment Before Pour</th> <th style="width: 30%;">Adjustment After Pour</th> </tr> </thead> <tbody> <tr> <td>(3) 1/2" (12.7mm), (5) 3/4" (19.1mm) (2) 1" (25mm)</td> <td style="text-align: center;">53</td> <td style="text-align: center;">1 3/4" (44mm)</td> <td style="text-align: center;">1/2" (12.7mm)</td> </tr> </tbody> </table> <p>Country of Origin: Mexico</p>	TECHNICAL SPECIFICATIONS				Conduit Openings	Cubic Inch Capacity	Adjustment Before Pour	Adjustment After Pour	(3) 1/2" (12.7mm), (5) 3/4" (19.1mm) (2) 1" (25mm)	53	1 3/4" (44mm)	1/2" (12.7mm)
TECHNICAL SPECIFICATIONS													
Conduit Openings	Cubic Inch Capacity	Adjustment Before Pour	Adjustment After Pour										
(3) 1/2" (12.7mm), (5) 3/4" (19.1mm) (2) 1" (25mm)	53	1 3/4" (44mm)	1/2" (12.7mm)										
<p>880S2</p> 	<p>Two-Gang Stamped Steel Floor Box – Fully Adjustable.</p> <table border="1" style="width: 100%; border-collapse: collapse;"> <thead> <tr> <th colspan="4" style="background-color: #333; color: white;">TECHNICAL SPECIFICATIONS</th> </tr> <tr> <th style="width: 40%;">Conduit Openings</th> <th style="width: 15%;">Cubic Inch Capacity</th> <th style="width: 15%;">Adjustment Before Pour</th> <th style="width: 30%;">Adjustment After Pour</th> </tr> </thead> <tbody> <tr> <td>(4) 1/2" (12.7mm), (8) 3/4" (19.1mm) (4) 1" (25mm)</td> <td style="text-align: center;">117 (58/59)</td> <td style="text-align: center;">1 3/4" (44mm)</td> <td style="text-align: center;">1/2" (12.7mm)</td> </tr> </tbody> </table> <p>Country of Origin: Mexico</p>	TECHNICAL SPECIFICATIONS				Conduit Openings	Cubic Inch Capacity	Adjustment Before Pour	Adjustment After Pour	(4) 1/2" (12.7mm), (8) 3/4" (19.1mm) (4) 1" (25mm)	117 (58/59)	1 3/4" (44mm)	1/2" (12.7mm)
TECHNICAL SPECIFICATIONS													
Conduit Openings	Cubic Inch Capacity	Adjustment Before Pour	Adjustment After Pour										
(4) 1/2" (12.7mm), (8) 3/4" (19.1mm) (4) 1" (25mm)	117 (58/59)	1 3/4" (44mm)	1/2" (12.7mm)										
<p>880S3</p> 	<p>Three-Gang Stamped Steel Floor Box – Fully Adjustable.</p> <table border="1" style="width: 100%; border-collapse: collapse;"> <thead> <tr> <th colspan="4" style="background-color: #333; color: white;">TECHNICAL SPECIFICATIONS</th> </tr> <tr> <th style="width: 40%;">Conduit Openings</th> <th style="width: 15%;">Cubic Inch Capacity</th> <th style="width: 15%;">Adjustment Before Pour</th> <th style="width: 30%;">Adjustment After Pour</th> </tr> </thead> <tbody> <tr> <td>(5) 1/2" (12.7mm), (11) 3/4" (19.1mm) (6) 1" (25mm)</td> <td style="text-align: center;">180 (56/68/56)</td> <td style="text-align: center;">1 3/4" (44mm)</td> <td style="text-align: center;">1/2" (12.7mm)</td> </tr> </tbody> </table> <p>Country of Origin: Mexico</p>	TECHNICAL SPECIFICATIONS				Conduit Openings	Cubic Inch Capacity	Adjustment Before Pour	Adjustment After Pour	(5) 1/2" (12.7mm), (11) 3/4" (19.1mm) (6) 1" (25mm)	180 (56/68/56)	1 3/4" (44mm)	1/2" (12.7mm)
TECHNICAL SPECIFICATIONS													
Conduit Openings	Cubic Inch Capacity	Adjustment Before Pour	Adjustment After Pour										
(5) 1/2" (12.7mm), (11) 3/4" (19.1mm) (6) 1" (25mm)	180 (56/68/56)	1 3/4" (44mm)	1/2" (12.7mm)										
<p>880M1</p> 	<p>One-Gang Shallow Stamped Steel Floor Box – Fully Adjustable.</p> <table border="1" style="width: 100%; border-collapse: collapse;"> <thead> <tr> <th colspan="4" style="background-color: #333; color: white;">TECHNICAL SPECIFICATIONS</th> </tr> <tr> <th style="width: 40%;">Conduit Openings</th> <th style="width: 15%;">Cubic Inch Capacity</th> <th style="width: 15%;">Adjustment Before Pour</th> <th style="width: 30%;">Adjustment After Pour</th> </tr> </thead> <tbody> <tr> <td>(5) 1/2" (12.7mm), (5) 3/4" (19.1mm)</td> <td style="text-align: center;">37</td> <td style="text-align: center;">1 3/4" (44mm)</td> <td style="text-align: center;">1/2" (12.7mm)</td> </tr> </tbody> </table> <p>Country of Origin: Mexico</p>	TECHNICAL SPECIFICATIONS				Conduit Openings	Cubic Inch Capacity	Adjustment Before Pour	Adjustment After Pour	(5) 1/2" (12.7mm), (5) 3/4" (19.1mm)	37	1 3/4" (44mm)	1/2" (12.7mm)
TECHNICAL SPECIFICATIONS													
Conduit Openings	Cubic Inch Capacity	Adjustment Before Pour	Adjustment After Pour										
(5) 1/2" (12.7mm), (5) 3/4" (19.1mm)	37	1 3/4" (44mm)	1/2" (12.7mm)										
<p>880M2</p> 	<p>Two-Gang Shallow Stamped Steel Floor Box – Fully Adjustable.</p> <table border="1" style="width: 100%; border-collapse: collapse;"> <thead> <tr> <th colspan="4" style="background-color: #333; color: white;">TECHNICAL SPECIFICATIONS</th> </tr> <tr> <th style="width: 40%;">Conduit Openings</th> <th style="width: 15%;">Cubic Inch Capacity</th> <th style="width: 15%;">Adjustment Before Pour</th> <th style="width: 30%;">Adjustment After Pour</th> </tr> </thead> <tbody> <tr> <td>(8) 1/2" (12.7mm), (8) 3/4" (19.1mm)</td> <td style="text-align: center;">80 40/40</td> <td style="text-align: center;">1 3/4" (44mm)</td> <td style="text-align: center;">1/2" (12.7mm)</td> </tr> </tbody> </table> <p>Country of Origin: Mexico</p>	TECHNICAL SPECIFICATIONS				Conduit Openings	Cubic Inch Capacity	Adjustment Before Pour	Adjustment After Pour	(8) 1/2" (12.7mm), (8) 3/4" (19.1mm)	80 40/40	1 3/4" (44mm)	1/2" (12.7mm)
TECHNICAL SPECIFICATIONS													
Conduit Openings	Cubic Inch Capacity	Adjustment Before Pour	Adjustment After Pour										
(8) 1/2" (12.7mm), (8) 3/4" (19.1mm)	80 40/40	1 3/4" (44mm)	1/2" (12.7mm)										
<p>880M3</p> 	<p>Three-Gang Shallow Stamped Steel Floor Box – Fully Adjustable.</p> <table border="1" style="width: 100%; border-collapse: collapse;"> <thead> <tr> <th colspan="4" style="background-color: #333; color: white;">TECHNICAL SPECIFICATIONS</th> </tr> <tr> <th style="width: 40%;">Conduit Openings</th> <th style="width: 15%;">Cubic Inch Capacity</th> <th style="width: 15%;">Adjustment Before Pour</th> <th style="width: 30%;">Adjustment After Pour</th> </tr> </thead> <tbody> <tr> <td>(11) 1/2" (12.7mm), (11) 3/4" (19.1mm)</td> <td style="text-align: center;">126 39/48/39</td> <td style="text-align: center;">1 3/4" (44mm)</td> <td style="text-align: center;">1/2" (12.7mm)</td> </tr> </tbody> </table> <p>Country of Origin: Mexico</p>	TECHNICAL SPECIFICATIONS				Conduit Openings	Cubic Inch Capacity	Adjustment Before Pour	Adjustment After Pour	(11) 1/2" (12.7mm), (11) 3/4" (19.1mm)	126 39/48/39	1 3/4" (44mm)	1/2" (12.7mm)
TECHNICAL SPECIFICATIONS													
Conduit Openings	Cubic Inch Capacity	Adjustment Before Pour	Adjustment After Pour										
(11) 1/2" (12.7mm), (11) 3/4" (19.1mm)	126 39/48/39	1 3/4" (44mm)	1/2" (12.7mm)										

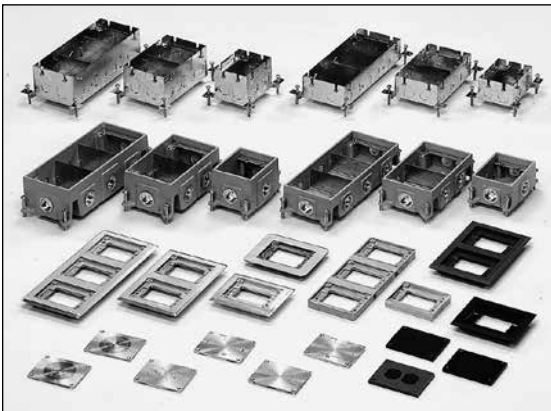

OmniBox Series Floor Boxes are available in a full range of box sizes, depths, and capacities with activation covers that enhance any decor and provide a full range of connectivity options.

OmniBox Series Cast Iron Floor Boxes Ordering Information

Catalog No./Item

Description/Specifications

880CS1-1

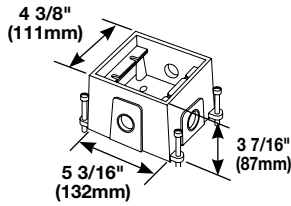

One-Gang Cast Iron Floor Box – Fully Adjustable.

TECHNICAL SPECIFICATIONS			
Conduit Openings	Cubic Inch Capacity	Adjustment Before Pour	Adjustment After Pour
(4) 1" (25mm)	48	1 3/4" (44mm)	1/2" (12.7mm)

Country of Origin: China

880CS2-1

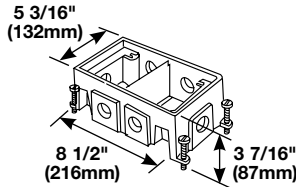

Two-Gang Cast Iron Floor Box – Fully Adjustable.

TECHNICAL SPECIFICATIONS			
Conduit Openings	Cubic Inch Capacity	Adjustment Before Pour	Adjustment After Pour
(6) 1" (25mm)	94 (45/49)	1 3/4" (44mm)	1/2" (12.7mm)

Country of Origin: China

880CS3-1

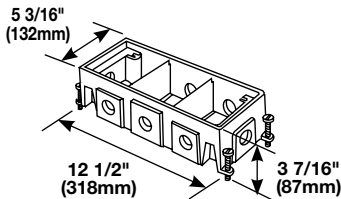

Three-Gang Cast Iron Floor Box – Fully Adjustable.

TECHNICAL SPECIFICATIONS			
Conduit Openings	Cubic Inch Capacity	Adjustment Before Pour	Adjustment After Pour
(8) 1" (25mm)	160 (53/54/53)	1 3/4" (44mm)	1/2" (12.7mm)

Country of Origin: China

880CS1-NA

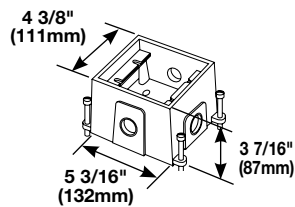

North America Made One-Gang Cast Iron Floor Box – Fully Adjustable.

Conduit Openings	Cubic Inch Capacity	Adjustment Before Pour	Adjustment After Pour
(4) 1" (25mm)	48	1 3/4" (44mm)	1/2" (12.7mm)

Country of Origin: USA

880CS2-NA

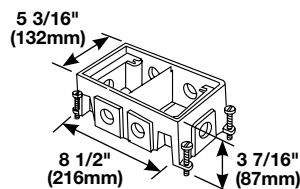

North America Made Two-Gang Cast Iron Floor Box – Fully Adjustable.

TECHNICAL SPECIFICATIONS			
Conduit Openings	Cubic Inch Capacity	Adjustment Before Pour	Adjustment After Pour
(6) 1" (25mm)	94 (45/49)	1 3/4" (44mm)	1/2" (12.7mm)

Country of Origin: USA

880CS3-NA

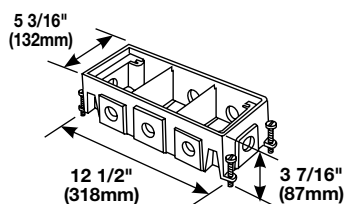

North America Made Three-Gang Cast Iron Floor Box – Fully Adjustable.

TECHNICAL SPECIFICATIONS			
Conduit Openings	Cubic Inch Capacity	Adjustment Before Pour	Adjustment After Pour
(8) 1" (25mm)	160 (53/54/53)	1 3/4" (44mm)	1/2" (12.7mm)

Country of Origin: USA



Single-gang stamped steel and triple-gang cast iron models of OmniBox Series Floor Boxes.

OmniBox Series Cast Iron Floor Boxes Ordering Information (continued)

Catalog No./Item

Description/Specifications

880CM1-1

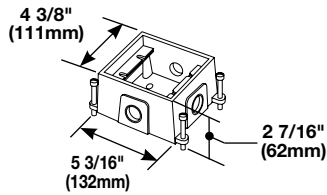

One-Gang Shallow Cast Iron Floor Box – Fully Adjustable.

TECHNICAL SPECIFICATIONS

Conduit Openings	Cubic Inch Capacity	Adjustment Before Pour	Adjustment After Pour
(4) 1" (25mm),	34	1 3/4" (44mm)	1/2" (12.7mm)

Country of Origin: USA

880CM2-1

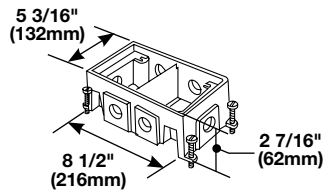

Two-Gang Shallow Cast Iron Floor Box – Fully Adjustable.

TECHNICAL SPECIFICATIONS

Conduit Openings	Cubic Inch Capacity	Adjustment Before Pour	Adjustment After Pour
(6) 1" (25mm),	76 36/40	1 3/4" (44mm)	1/2" (12.7mm)

Country of Origin: USA

880CM3-1

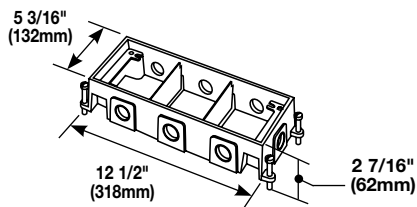

Three-Gang Shallow Cast Iron Floor Box – Fully Adjustable.

TECHNICAL SPECIFICATIONS

Conduit Openings	Cubic Inch Capacity	Adjustment Before Pour	Adjustment After Pour
(8) 1" (25mm),	118 39/40/39	1 3/4" (44mm)	1/2" (12.7mm)

Country of Origin: USA

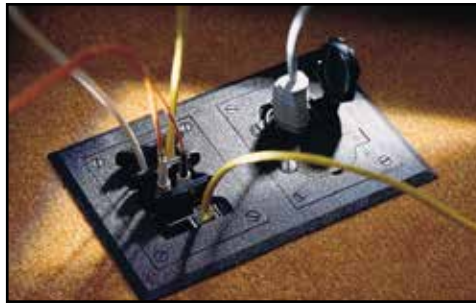

Cover Plates for OmniBox Series Floor Boxes provide access to a wide range of connectivity and are available in both metal and nonmetallic fabrications.

OmniBox Series Floor Boxes Solid Brass Cover Plate Flanges Ordering Information

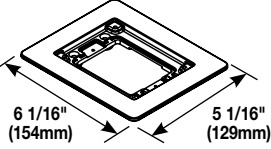
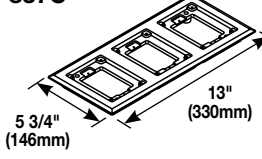
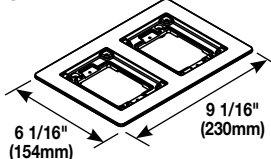
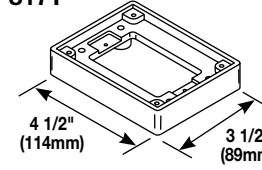
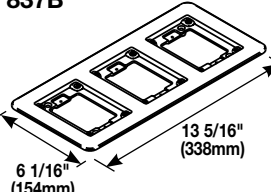
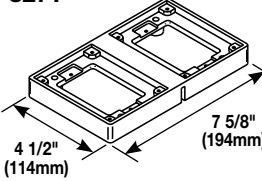
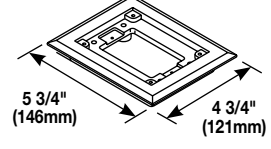
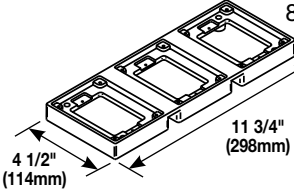
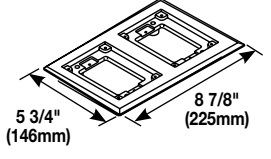
Catalog No./Item	Description/Specifications	Catalog No./Item	Description/Specifications
817B 	One-Gang Brass Combination Carpet & Tile Flange – Accepts Ortronics® MAB6TJ TracJack and MAB3S2 Series II adapters and Wiremold CM Series inserts, sold separately. Country of Origin: China	837C 	Three-Gang Brass Carpet Flange – For use on 880S3, 880M3, 880CS32-1, and 880CM3-1 Floor Boxes. Country of Origin: China
827B 	Two-Gang Brass Combination Carpet and Tile Flange – Accepts Ortronics® MAB6TJ TracJack and MAB3S2 Series II adapters and Wiremold CM Series inserts, sold separately. Country of Origin: China	817T 	One-Gang Brass Tile Flange – For use on 880S1, 880M1, 880CS1-1, and 880M1-1 Floor Boxes. Country of Origin: China
837B 	Three-Gang Brass Combination Carpet and Tile Flange – Accepts Ortronics® MAB6TJ TracJack and MAB3S2 Series II adapters and Wiremold CM Series inserts, sold separately. Country of Origin: China	827T 	Two-Gang Brass Tile Flange – For use on 880S2, 880M2, 880CS2-1, and 880CM2-1 Floor Boxes. Country of Origin: China
817C 	One-Gang Brass Carpet Flange – For use on 880S1, 880M1, 880CS1-1, and 880CM1-1 Floor Boxes. Country of Origin: China	837T 	Three-Gang Brass or Brushed Aluminum Tile Flange – For use on 880S3, 880M3, 880CS3-1, and 880CM3-1 Floor Boxes. Country of Origin: China
827C 	Two-Gang Brass Carpet Flange – For use on 880S2, 880M2, 880CS2-1, and 880CM2-1 Floor Boxes. Country of Origin: China		

NOTE: UL Listed for tile, terrazzo, and carpet floors.

Brass covers and flanges are not interchangeable with aluminum or nonmetallic covers and flanges. Nonmetallic covers are interchangeable with aluminum flanges.

All cover assemblies for the OmniBox Floor Box Series have TopGuard protection.

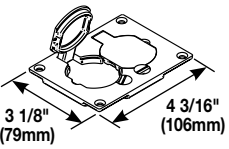
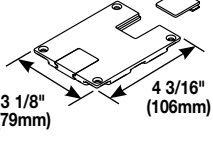
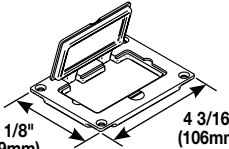
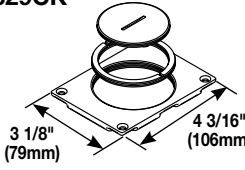
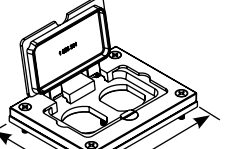
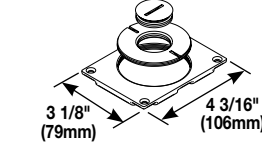
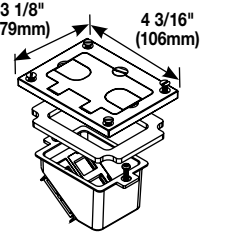
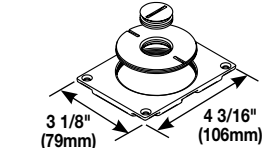
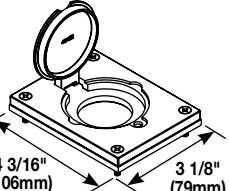
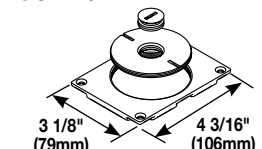
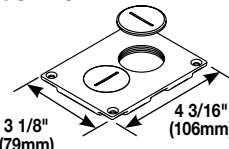
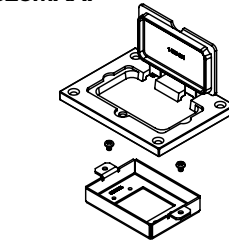

OmniBox Series Floor Boxes Metal Cover Plates Ordering Information

Catalog No./Item	Description/Specifications	Catalog No./Item	Description/Specifications
828R 	Brass Duplex Cover Plate – Flip lids. Can also be used with a 106 type communication adapter. Country of Origin: China	829STC 	Brass Communication Cover Plate – Data slides. Feed through only, not for use with a mounting plate for communication jacks. Country of Origin: China
828GFITC 	Brass GFI Cover Plate – May be used with Activate and Ortronics® Connectivity Systems in conjunction with 817B, 827B, and 837B Flanges. Country of Origin: China	829CK 	Brass Communication Cover Plate – 2 5/8" and 2 1/4" (67mm and 57mm) plugs. Country of Origin: China
828DPGFITC 	Brass Rectangular Cover Plate – Allows for mounting of a duplex style receptacle with a rectangular style flip lid cover. Country of Origin: China	829CK-1 	Brass Communication Cover Plate – 2 5/8" and 1" (67mm and 25mm) plugs. Country of Origin: China
828COMTC 	Brass Communication Cover Plate – Allows for up to four communication devices to be mounted in a recessed position within the 880 Floor Box. The 828COM Cover Plate has removable slides for cable egress. Country of Origin: China	829CK-3/4 	Brass Communication Cover Plate – 2 5/8" and 3/4" (67mm and 19.1mm) plugs. Country of Origin: China
828DLR 	Brass Single Locking Receptacle Cover Plate – Single flip lid cover for 20A or 30A single locking receptacles. Device opening is 2 5/8" (67mm). For use with maximum female locking device of 1.58" diameter, and maximum male plug face of 2.25" diameter Country of Origin: China	829CK-1/2 	Brass Communication Cover Plate – 2 5/8" and 1/2" (67mm and 12.7mm) plugs. Country of Origin: China
828SPTC 	Brass Duplex Cover Plate – Screw plugs. Screw plugs are 1 1/2" (38mm) in diameter. Country of Origin: China	828MAAP 	A/V Adapter Plate – Sheet metal adapter plate that accepts two (2) Extron- Electronics MAAP style device plates (sold separately). For use with 828GFITC or 828GFITCAL cover plates. (Sold separately) Country of Origin: USA

NOTE: Brass covers and flanges are not interchangeable with aluminum or nonmetallic covers and flanges. Nonmetallic covers are interchangeable with aluminum flanges.

All cover assemblies for the OmniBox Floor Box Series have TopGuard protection.

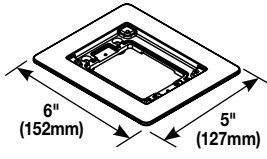
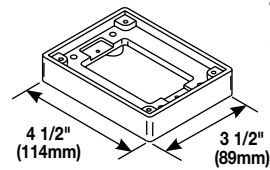
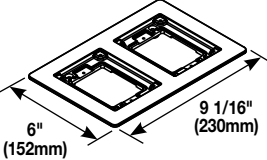
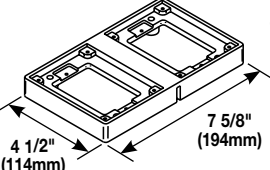
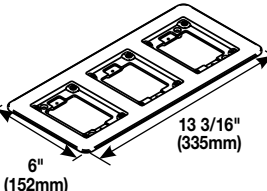
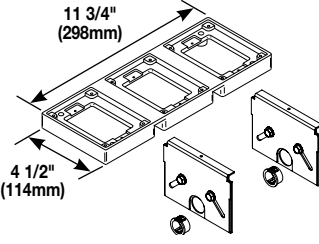

OmniBox Series Floor Boxes Brushed Aluminum Cover Plate Flanges Ordering Information

Catalog No./Item	Description/Specifications
<p>818TCAL</p>  <p style="text-align: center;">Country of Origin: China</p> <p>NOTE: Brushed aluminum flanges come with beveled edges.</p>	<p>818TAL</p> <p>One-Gang Brushed Aluminum Tile Flange – For use on 880S1, 880M1, 880CS1-1, and 880M1-1 Floor Boxes.</p>  <p style="text-align: center;">Country of Origin: China</p>
<p>828TCAL</p>  <p style="text-align: center;">Country of Origin: China</p> <p>NOTE: Brushed aluminum flanges come with beveled edges.</p>	<p>828TAL</p> <p>Two-Gang Brushed Aluminum Tile Flange – For use on 880S2, 880M2, 880CS2-1, and 880CM2-1 Floor Boxes.</p>  <p style="text-align: center;">Country of Origin: China</p>
<p>838TCAL</p>  <p style="text-align: center;">Country of Origin: China</p> <p>NOTE: Brushed aluminum flanges come with beveled edges.</p>	<p>838TAL-880S3 838TAL-880M3 838TAL-880CS3 838TAL-880CM3</p> <p>Kit – The 838TAL-880 Series flanges provide additional tile load support for 3-gang tile flanges. Kit includes 838TAL Flange and two support dividers.</p>  <p style="text-align: center;">Country of Origin: USA</p> <p>NOTE: Order kit for specific box type: 880S3, 880M3, 880CS3, or 880CM3.</p>

NOTE: UL Listed for tile, terrazzo, and carpet floors.

Brass covers and flanges are not interchangeable with aluminum or nonmetallic covers and flanges. Nonmetallic covers are interchangeable with aluminum flanges.

All cover assemblies for the OmniBox Floor Box Series have TopGuard protection.

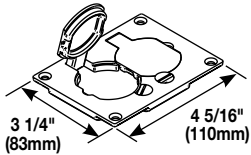
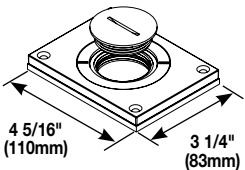
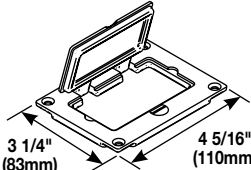
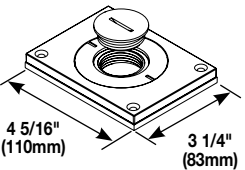
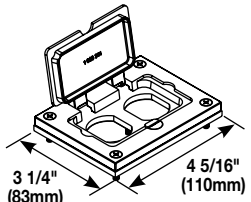
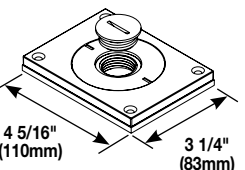
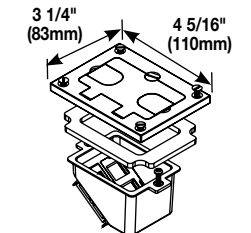
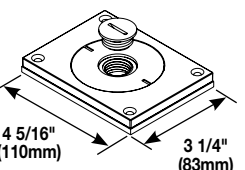
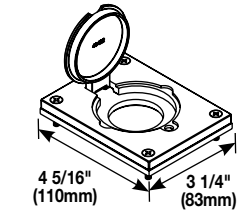
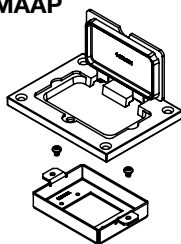

OmniBox Series Floor Boxes Metal Cover Plates Ordering Information

Catalog No./Item	Description/Specifications	Catalog No./Item	Description/Specifications
828R-TCAL 	Brushed Aluminum Duplex Cover Plate – Flip lids. Can also be used with a 106 type communication adapter. Country of Origin: China	830KTCAL 	Brushed Aluminum Cover Plate – Power or communication plate with 2" (51mm) and 1 1/4" (32mm) plugs. Country of Origin: China NOTE: Acceptable for use with threaded conduit when passing through power cables.
828GFITCAL 	Brushed Aluminum GFI Cover Plate – May be used with Activate and Ortronics® Connectivity Systems in conjunction with 817B, 827B, and 837B Flanges. Country of Origin: China	830KTCAL-1 	Brushed Aluminum Cover Plate – Power or communication plate with 2" (51mm) and 1" (25mm) plugs. Country of Origin: China NOTE: Acceptable for use with threaded conduit when passing through power cables.
828DPGFITCAL 	Brushed Aluminum Rectangular Cover Plate – Allows for mounting of a duplex style receptacle with a rectangular style flip lid cover. Country of Origin: China	830KTCAL-3/4 	Brushed Aluminum Cover Plate – Power or communication plate with 2" (51mm) and 3/4" (19.1mm) plugs. Country of Origin: China NOTE: Acceptable for use with threaded conduit when passing through power cables.
828COMTCAL 	Brushed Aluminum Communication Cover Plate – Allows for up to four communication devices to be mounted in a recessed position within the 880 Floor Box. The 828COMTCAL Cover Plate has removable slides for cable egress. Country of Origin: China NOTE: For use with 880S and 880CS Series Boxes only.	830KTCAL-1/2 	Brushed Aluminum Cover Plate – Power or communication plate with 2" (51mm) and 1/2" (12.7mm) plugs. Country of Origin: China NOTE: Acceptable for use with threaded conduit when passing through power cables.
828DLRAL 	Brushed Aluminum Single Locking Receptacle Cover Plate – Single flip lid cover for 20A or 30A single locking receptacles. Device opening is 2 5/8" (67mm). For use with maximum female locking device of 1.58" diameter, and maximum male plug face of 2.25" diameter Country of Origin: China	828MAAP 	A/V Adapter Plate – Sheet metal adapter plate that accepts two (2) Extron® Electronics MAAP style device plates (sold separately). For use with 828GFITC or 828GFITCAL cover plates. (Sold separately) Country of Origin: USA

NOTE: Brass covers and flanges are not interchangeable with aluminum or nonmetallic covers and flanges. Nonmetallic covers are interchangeable with aluminum flanges.

All cover assemblies for the OmniBox Floor Box Series have TopGuard protection.

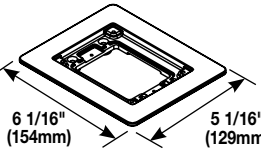
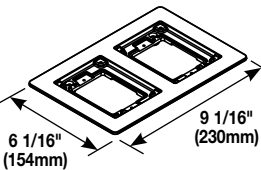
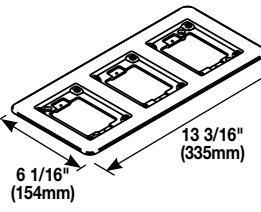
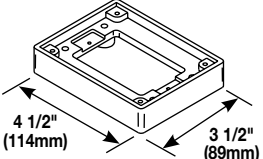
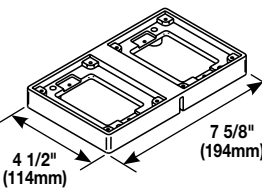
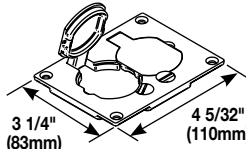
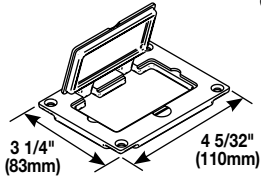
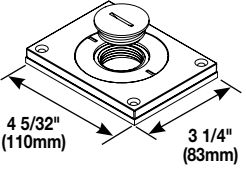

OmniBox Series Floor Boxes Powder-Coated Aluminum Cover Plate Flanges Ordering Information

Catalog No./Item	Description/Specifications
<p>817TCAL-BK 817TCAL-GY 817TCAL-BS 817TCAL-NK 817TCAL-BZ</p>  <p style="text-align: center;">6 1/16" (154mm) 5 1/16" (129mm)</p>	<p>One-Gang Powder-Coated Aluminum Combination Carpet and Tile Flange – Accepts Ortronics® MAB6TJ TracJack and MAB3S2 Series II adapters and Wiremold CM Series inserts, sold separately. Flanges are available in five decorative colors: black, gray brass, nickel and bronze.</p> <p style="text-align: center;">Country of Origin: USA</p>
<p>827TCAL-BK 827TCAL-GY 827TCAL-BS 827TCAL-NK 827TCAL-BZ</p>  <p style="text-align: center;">6 1/16" (154mm) 9 1/16" (230mm)</p>	<p>Two-Gang Powder-Coated Aluminum Combination Carpet and Tile Flange – Accepts Ortronics® MAB6TJ TracJack and MAB3S2 Series II adapters and Wiremold CM Series inserts, sold separately. Flanges are available in five decorative colors: black, gray brass, nickel and bronze.</p> <p style="text-align: center;">Country of Origin: USA</p>
<p>837TCAL-BK 837TCAL-GY 837TCAL-BS 837TCAL-NK 837TCAL-BZ</p>  <p style="text-align: center;">6 1/16" (154mm) 13 3/16" (335mm)</p>	<p>Three-Gang Powder-Coated Aluminum Combination Carpet and Tile Flange – Accepts Ortronics® MAB6TJ TracJack and MAB3S2 Series II adapters and Wiremold CM Series inserts, sold separately. Flanges are available in five decorative colors: black, gray brass, nickel and bronze.</p> <p style="text-align: center;">Country of Origin: USA</p>
<p>817TAL-BK 817TAL-GY 817TAL-BS 817TAL-NK 817TAL-BZ</p>  <p style="text-align: center;">4 1/2" (114mm) 3 1/2" (89mm)</p>	<p>One-Gang Powder-Coated Aluminum Tile Flange – For use on 880S1, 880M1, 880CS1-1, and 880M1-1 Floor Boxes. Flanges are available in five decorative colors: black, gray brass, nickel and bronze.</p> <p style="text-align: center;">Country of Origin: USA</p>
<p>827TAL-BK 827TAL-GY 827TAL-BS 827TAL-NK 827TAL-BZ</p>  <p style="text-align: center;">4 1/2" (114mm) 7 5/8" (194mm)</p>	<p>Two-Gang Powder-Coated Aluminum Tile Flange – For use on 880S2, 880M2, 880CS2-1, and 880CM2-1 Floor Boxes. Flanges are available in five decorative colors: black, gray brass, nickel and bronze.</p> <p style="text-align: center;">Country of Origin: USA</p>
<p>828R-TCALBK 828R-TCALGY 828R-TCALBS 828R-TCALNK 828R-TCALBZ</p>  <p style="text-align: center;">3 1/4" (83mm) 4 5/32" (110mm)</p>	<p>Powder-Coated Aluminum Duplex Cover Plate – Flip lids. Can also be used with a 106 type communication adapter.</p> <p style="text-align: center;">Country of Origin: USA</p>
<p>828GFITCAL-BK 828GFITCAL-GY 828GFITCAL-BS 828GFITCAL-NK 828GFITCAL-BZ</p>  <p style="text-align: center;">3 1/4" (83mm) 4 5/32" (110mm)</p>	<p>Powder-Coated Aluminum Rectangular Cover Plate – Allows for mounting a duplex receptacle (Decorator or GFCI style) with a rectangular flip cover</p> <p style="text-align: center;">Country of Origin: USA</p>
<p>829CKAL-1BK 829CKAL-1GY 829CKAL-1BS 829CKAL-1NK 829CKAL-1BZ</p>  <p style="text-align: center;">4 5/32" (110mm) 3 1/4" (83mm)</p>	<p>Powder-Coated Aluminum Cover Plate – Power or communication plate with 2" (51mm) and 1" (25mm) plugs. Covers are available in five decorative colors: black, gray brass, nickel and bronze.</p> <p style="text-align: center;">Country of Origin: USA</p> <p>NOTE: Acceptable for use with threaded conduit when passing through power cables.</p>

NOTE: Pricing varies depending on country of origin. Consult your local sales representative for more information.

OmniBox Series Floor Boxes Powder-Coated Aluminum Cover Plate Flanges Ordering Information (Continued)

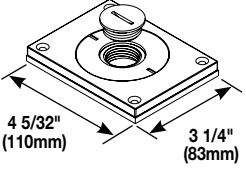
Catalog No./Item	Description/Specifications
829CKAL-3/4BK 829CKAL-3/4GY 829CKAL-3/4BS 829CKAL-3/4NK 829CKAL-3/4BZ	<p>Powder-Coated Aluminum Cover Plate – Power or communication plate with 2" (51mm) and 3/4" (19.1mm) plugs. Covers are available in five decorative colors: black, gray brass, nickel and bronze.</p> <p>Country of Origin: USA</p>  <p>NOTE: Acceptable for use with threaded conduit when passing through power cables.</p>

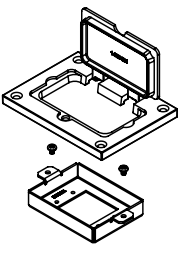
Catalog No./Item	Description/Specifications
828MAAP 	<p>A/V Adapter Plate – Sheet metal adapter plate that accepts two (2) Extron® Electronics MAAP style device plates (sold separately). For use with 828GFITC or 828GFITCAL cover plates. (Sold separately)</p> <p>Country of Origin: USA</p>

NOTE: UL Listed for tile, terrazzo, and carpet floors.

Brass covers and flanges are not interchangeable with aluminum or nonmetallic covers and flanges. Nonmetallic covers are interchangeable with aluminum flanges.

OmniBox Series Floor Boxes Nonmetallic Cover Plate Flanges Ordering Information

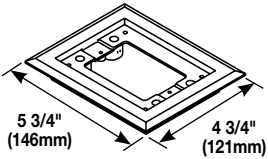
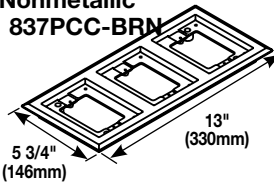
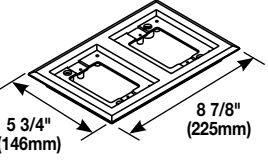
Catalog No./Item	Description/Specifications	Catalog No./Item	Description/Specifications
817PCC-BLK 817PCC-BRN	<p>One-Gang Nonmetallic Carpet Flange – Available in black or brown. For Ortronics® connectivity use with 829PFLRT Cover. For Activate connectivity use with 829PFL Cover. Accepts Ortronics® MAB6TJ TracJack and MAB3S2 Series II adapters and Wiremold CM Series inserts, sold separately.</p> <p style="text-align: center;">Country of Origin: Mexico</p>	Nonmetallic 837PCC-BRN	<p>Three-Gang Flange – Available in black or brown. For Ortronics® connectivity use with 829PFLRT Cover. For Activate connectivity use with 829PFL Cover. Accepts Ortronics® MAB6TJ TracJack and MAB3S2 Series II adapters and Wiremold CM Series inserts, sold separately.</p> <p style="text-align: center;">Country of Origin: Mexico</p>
			
827PCC-BLK 827PCC-BRN	<p>Two-Gang Nonmetallic Carpet Flange – Available in black or brown. For Ortronics® connectivity use with 829PFLRT Cover. For Activate connectivity use with 829PFL Cover. Accepts Ortronics® MAB6TJ TracJack and MAB3S2 Series II adapters and Wiremold CM Series inserts, sold separately.</p> <p style="text-align: center;">Country of Origin: Mexico</p>	<p>NOTE: UL Listed for tile, terrazzo, and carpet floors.</p> <p>Brass covers and flanges are not interchangeable with aluminum or nonmetallic covers and flanges. Nonmetallic covers are interchangeable with aluminum flanges.</p>	
			

OmniBox Series Floor Boxes Nonmetallic Cover Plates Ordering Information

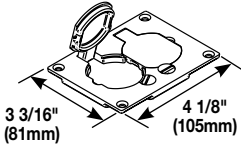
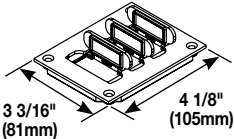
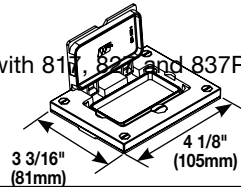
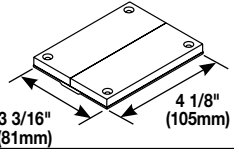
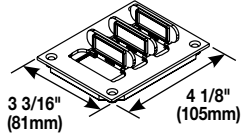
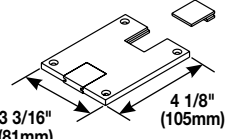
Catalog No./Item	Description/Specifications	Catalog No./Item	Description/Specifications
828PR-BLK 828PR-BRN	<p>Nonmetallic Duplex Cover Plate – Flip lids. Available in black or brown. Can also be used with a 106 type communication adapter.</p> <p style="text-align: center;">Country of Origin: USA</p>	829PFLRT-BLK 829PFLRT-BRN	<p>Nonmetallic Communication Cover Plate – Individual flip lids.* Available in black or brown. Gasket included. Ortronics® MAB6TJ TracJack and MAB3S2 Series II adapters included.</p> <p style="text-align: center;">Country of Origin: USA</p>
			
828PRGFI-BLK 828PRGFI-BRN	<p>Nonmetallic GFI Cover Plate – Available in black or brown. May be used with Ortronics® Connectivity systems in conjunction with 817PCC, 827PCC, and 837PCC Series flanges.</p> <p style="text-align: center;">Country of Origin: USA</p>	829PCK-BLK 829PCK-BRN	<p>Nonmetallic Communication Cover Plate – Breakouts. Available in black or brown. Feed through only, not for use with a mounting plate for communication jacks.</p> <p style="text-align: center;">Country of Origin: USA</p>
			
829PFL-BLK 829PFL-BRN	<p>Nonmetallic Communication Cover Plate – Individual flip lids.* Available in black or brown. Gasket included. Wiremold CM Series inserts included.</p> <p style="text-align: center;">Country of Origin: USA</p>	829PSTC-BLK 829PSTC-BRN	<p>Nonmetallic Communication Cover Plate – Data slides. Available in black or brown. Feed through only, not for use with a mounting plate for communication jacks.</p> <p style="text-align: center;">Country of Origin: USA</p>
			

*Replacement flip lids can be ordered under Cat. No. PFL-BLK and PFL-BRN. Each Cat. No. comes with three flip lids. The above cover plates are listed for tile, terrazzo, and carpet floors.

NOTE: Brass covers and flanges are not interchangeable with aluminum or nonmetallic covers and flanges. Nonmetallic covers are interchangeable with aluminum flanges.

NOTE: All brand and product names referenced in this document are registered trademarks or trademarks of their respective holders.



NOTE: The paper used to print this document is an environmentally responsible paper with 10% post consumer waste, with FSC and SFI Chain of Custody certifications, Lacey Act compliant. 100% of the electricity used to manufacture Flo sheets is generated with Green-e certified renewable energy.



Electrical Wiring Systems

60 Woodlawn Street
West Hartford, CT 06110
Phone: 1.877.BY.LEGRAND (295-3472)
www.legrand.us

570 Applewood Crescent
Vaughan, Ontario L4K 4B4
Phone: 905.738.9195
www.legrand.ca

