

**Delkor**

Singapore  
31 International Business Park  
#03-02/02  
Singapore 609921

Australia  
13 Compark Circuit, Mulgrave  
Victoria, Australia, 3170  
Tel: +61-3-9751-5003

Japan  
Yokohama Helwa Bldg. 3-30-7  
Honcho Naka-ku Yokohama Kanagawa  
231-0005 Japan  
Tel: +81-(0)45-274-8401

Korea  
Woodeok building, Floor 8, 330, Gangnam-daero, Gangnam-gu  
Seoul 06252, Korea  
Tel: +82-(0)2-529-8975

**Delkor**<sup>®</sup>

## Battery Care Manual



- 01 Why is battery care important?**
- 01 What is a maintenance-free battery?**
- 03 What should you consider when replacing a battery?**
  - 03 For Automotive batteries
  - 03 For Deep Cycle batteries
- 04 Safety precautions when handling batteries**
  - 05 Importance of regular inspection of battery charge level
  - 05 How to handle and store maintenance-free batteries
  - 06 Tips on checking for malfunctions
  - 07 Step-by-step checklist to identify battery status
  - 08 Things to be mindful of when charging and maintaining your battery
- 09 When and how to charge your battery**
  - 09 Preparation before charging
    - 10 Checking terminal voltage
    - 10 Measuring terminal voltage
    - 10 Recharging and charger capacity recommendations
  - 11 Charging methods
    - 11 Constant voltage charging
    - 12 Constant current charging
- 17 Battery replacement**
  - 17 Safety precautions when replacing the battery
  - 18 How to jump-start your car battery
  - 18 Legal Disclaimer

Battery models available vary from country to country.



## Why is battery care important?

Modern cars are becoming more reliable, promising higher performance. The demand for electrical cars is also growing.

Before the 1980s, the key cause of car breakdowns was a flat tyre or mechanical defect. However, over the past years, battery failures have become the most common reason for a car's involuntary stop.

Today, battery failures cause car breakdowns four times more than the mid 1990s. More often than not, poor battery care or failure to replace the battery in time is the reason. Therefore, taking good care to maximise your car battery's life is critical.

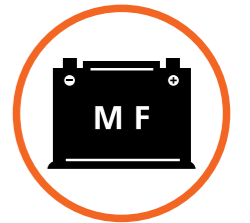

## What is a maintenance-free battery?

Traditional standard flooded batteries require regular top-ups of distilled water at workshops to maintain optimal performance.

Over the years, battery technology has improved. Today, almost all Lead-acid batteries, from Standard Flooded (SLI) to modern Absorbent Glass Mat (AGM) batteries, are maintenance-free.

Refilling batteries with distilled water is a thing of the past. However, a little care helps extend battery life and a regular check of the charge level helps detect a weak battery.

Learn more on battery technologies and identify the most suitable battery for your purpose at [www.delkor.com](http://www.delkor.com)



## What should you consider when replacing a battery?

### For Automotive batteries

Which battery is right for your car? Here are some quick tips to help you make the right choice.

Check the existing battery to ensure you are replacing it with battery technology of equal or better performance and features. For example, if your vehicle is using an EFB battery, it should be replaced with either an EFB or AGM battery. You should also check your vehicle manual for the original equipment manufacturer's recommendations for:

#### Battery Group Size:

The battery size that will best fit the physical dimensions of your vehicle. Many vehicles can accommodate more than one group size.

#### Cold Cranking Amperes (CCA):

This is critical for good cranking ability. It is the number of amperes a battery can support for 30 seconds at a temperature of -18°C until the battery voltage drops to unusable levels.

#### Reserve Capacity (RC):

This helps power your vehicle's electrical system if the alternator fails. It identifies the number of minutes a battery can supply ample power without falling below the minimum voltage needed to run your vehicle.

In general, for both CCA and RC, the higher the number the better. Should you live in a cold climate, the CCA rating should be an important consideration in choosing a battery. Conversely, if you live in a high-heat climate, you do not need as much CCA.

### For Deep Cycle batteries

Determine your battery power needs by:

1. Considering the type of equipment fitted or to be fitted
2. Checking the number of amperes needed to run each piece of equipment
3. Determining the number of hours you will be using each piece of equipment
4. Multiplying the current draw by the duration to determine the Ampere Hours (Ah) required:
  - Equipment Current Draw (Amperes) x Time (hours) = Ah
  - This will be the required amount of Ampere Hours (Ah) to be delivered for the specified time and voltage
5. As a safety precaution, increase the total Ampere Hours (Ah) required by at least 20%

Here is an example for a fishing boat:

| Equipment      | Amperes |   | Hours      |   | Ampere Hours (Ah) |
|----------------|---------|---|------------|---|-------------------|
| Lights         | 1       | x | 5          | = | 5                 |
| Trolling Motor | 10      | x | 5          | = | 50                |
| Fish Locator   | 3       | x | 5          | = | 15                |
| Radio          | 1       | x | 5          | = | 5                 |
|                |         |   | Total      | = | 75                |
|                |         |   | 75Ah + 20% | = | 90                |



## Safety precautions when handling batteries

When fitting and handling batteries, please make sure you and your colleagues are aware of all safety precautions and handling procedures. Do adhere to the safety recommendations and advice below, as well as the handling instructions of your local regulator.

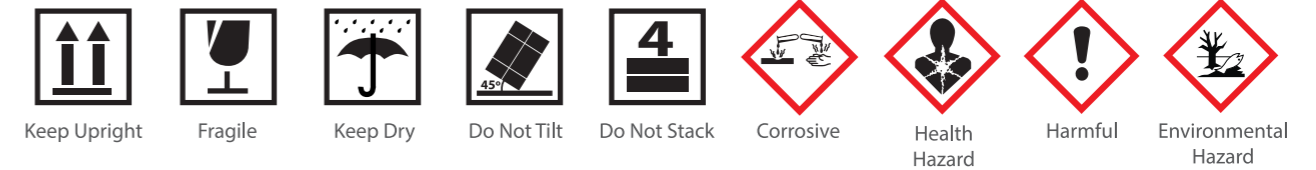

- Always read the vehicle owner's manual and safety instructions before handling the battery
- Always refer to the Safety Data Sheet (SDS) for more information
- Keep the battery away from flammable areas and objects
- Always wear safety glasses and rubber gloves when handling the battery
- Note that the battery fluid may emit hydrogen gas, which can cause fire or explosion
- Charge the battery in a well-ventilated area
- Prevent short-circuiting and/or emission of sparks
- The battery's electrolyte fluid (sulfuric acid) can cause blindness and/or severe burns. Keep the battery away from the eye, skin, clothes and other objects. If you come into contact with the battery fluid, wash the affected area with water immediately and thoroughly. If swallowed, drink a large quantity of water or milk immediately. If battery fluid is swallowed or comes into contact with the eye, you should see a doctor as soon as possible
- Keep the battery away from high temperatures and humidity. Avoid rain, snow or direct sunlight
- Do not tilt or attempt to disassemble the battery
- Do not attempt to quick-charge the battery
- Dispose of discarded batteries according to local regulations

#### Safety precautions when charging:

- ✓ Be sure to wear protective glasses before assessing or handling the battery
- ✓ Do not conduct charging near fire or sparks
- ✓ Do not charge a frozen battery
- ✓ If the human body or clothes come into contact with battery acid, rinse the affected area immediately with water
- ✓ If your eye comes into contact with battery acid, wash thoroughly with water and seek medical help immediately







### Importance of regular inspection of battery charge level

Reliable and adequate charging can considerably extend battery life. Regardless of the starter battery type used, always keep an eye on the charge level. This helps maintain the highest possible charge capacity.

If the vehicle is parked for long periods of time, a drop in voltage and harmful deep discharge may occur. This can be prevented with a suitable charger. Good chargers can detect the battery's charge capacity and also have an automatic charge current control. If the vehicle is not used frequently, charge the battery at intervals of about two months. This maintains battery performance as well as extends battery life.

Short journeys put an enormous strain on starter batteries, especially in cold weather. In winter temperatures, battery performance is restricted for chemical reasons. The alternator cannot provide an adequate charge over short distances. Therefore, it is even more important to check the battery charge level regularly. A headlight check gives an approximate impression: if the headlights dim quickly when the engine is switched off, the battery should be charged as soon as possible. Ideally, a professional check of the charge level should be carried out at regular intervals by your workshop.

### How to handle and store maintenance-free batteries

|   |  |
|---|--|
|   | <p>Store the battery in a cool, dry area (27°C), away from direct sunlight.</p>  |
|  | <p>Always store the battery in an upright position. Tilting the battery at an angle of 45° or more will cause battery acid to leak through the vents on the sides (except for AGM batteries, which are non-spillable). Refrain from placing any aqueous or solid (e.g. conductors) bodies on top of the battery.</p> |
|  | <p>Do not use tools, such as hammers, on the battery terminals when connecting cables to the mounted battery.</p>  |
|  | <p>When storing the battery for long periods of time, check the voltage of the battery every 3 months. If the Open Circuit Voltage (OCV) drops below 12.5V, recharge the battery before placing it back in storage.</p>  |
|  | <p>Always check the State of Charge (S.O.C.) indicator on the stored battery periodically. If the S.O.C. indicators appear black, recharge the battery immediately.</p>  |

### Tips on checking for malfunctions

Here are some helpful tips below. If for any reason you are unsure, please contact your nearest authorized Delkor® stockist.

- Check the color status of the State of Charge (S.O.C.) indicator
- Measure the Open Circuit Voltage (OCV)
- Check for additional corrosion and mileage
- Check the battery name and date of manufacture
- Check for any damage on the battery surface
- Check the terminals
- If possible, check the battery fluid level

What may constitute a possible manufacturing defect?

- ✓ Dead cell indicated by low specific gravity in one cell and low OCV
- ✓ InterCell connector failure — a near new battery has good specific gravity in all six cells but has low OCV and is unable to hold a low current load
- ✓ Dropped plates — not all plates are connected to strap. Low cranking performance with excessive gassing in affected cells under load
- ✓ Leaking from cover seal that has not been physically damaged
- ✓ Terminal leak from cover insert seal — acid creeping up terminal causing corrosion
- ✓ Case leak — acid leaking from injection point
- ✓ New battery with high electrolyte level leaking from vent system
- ✓ New battery with low electrolyte level below plates on one or more cells (could be leaking or under-filled)

**PLEASE NOTE**

Most manufacturing faults show up very early in battery service. Some of the faults listed may be caused by harsh service conditions.

What is NOT a genuine warranty/manufacturing defect?

- ✗ Any physical damage to the battery, battery case or terminals
- ✗ Sulfation of the battery
- ✗ Acid starvation — low electrolyte level
- ✗ Failures due to a lack of battery maintenance
- ✗ End of battery life
- ✗ Failures due to excess kilometer usage, which affects battery life
- ✗ Usage of an unsuitable battery for the application, such as:
  - Wrong capacity
  - Wrong fitment
  - Wrong battery case size
  - Wrong technology

Please refer to your Warranty Statement for more information.

## Step-by-step checklist to identify battery status

Step 1: Check the external surface of the battery

Damage to the battery's external surface (e.g. cracks) can cause leakage of battery fluid, which can bring about corrosion in the car. A dirty battery surface can also cause discharge. Therefore, batteries should be kept as clean as possible.

Step 2: Check the State of Charge (S.O.C.) indicator (Hydrometer)

Green: Battery is properly charged and ready for use

Black: Battery is discharged. Charge the battery until the S.O.C. indicator turns green

Clear: Low battery fluid. Inspect the charging system and replace the battery

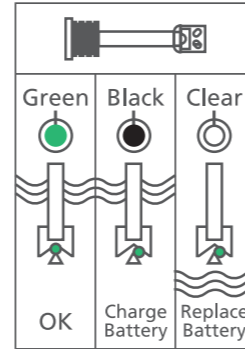

Step 3: Measure Open Circuit Voltage (OCV)

After turning off the car engine, the car should be allowed to rest for at least 3 hours before measuring voltage.

Step 4: Measure voltage using an electronic battery tester or visit your nearest dealer to get a battery check completed.

Electronic testing devices are only suitable for batteries in use for a certain period of time. They cannot provide any indication on the performance of new or unused batteries.

For this reason, we suggest confirming the nominal figures by conducting the tests as detailed in the relevant battery industry standard. Please be aware that electronic battery testers, also known as conductance testers, are not suitable for testing Cold Cranking Amperes (CCA) rankings in Lead-acid batteries.

**PLEASE NOTE**

When testing a cycling battery of any chemistry, a discharge test and tester must be used to validate the results. Normal testing methods are not suitable or reliable in these applications.

| State of Charge (%) | OCV (V) |
|---------------------|---------|
| 100                 | 12.78   |
| 85                  | 12.65   |
| 65                  | 12.47   |
| 50                  | 12.32   |
| 25                  | 12.07   |
| 0                   | 11.78   |

## Things to be mindful of when charging and maintaining your battery

Many newer battery chargers have microprocessors that collect information from the battery, adjusting the current and voltage accordingly. Some have different settings for charging Standard Flooded, Gel and AGM batteries. Before you start, always select the correct type of technology for the battery you are charging.

All wet Lead-acid batteries can experience sulfation — the formation of lead-sulfate crystals upon discharge. Look for a charger with a de-sulfation mode to help condition your battery and keep it performing at its best.

Low and slow is best. A low ampere charger (1A – 12A) is generally the best choice for charging any Lead-acid battery. It is quicker to charge at higher amperage but this can also generate a lot of heat, reducing battery life, just like the heat of summer.

Alternators are NOT chargers. An alternator is meant to maintain a battery, not charge it. Do not rely on your alternator to do the work of a charger. If your battery is discharged to the point where you are unable to start your vehicle, restore your battery to full charge as soon as possible, using a charger.

All batteries will eventually die. Batteries are consumable products and no battery will last forever. However, consistent maintenance of your battery will allow for longer battery life.

Different chargers have different capabilities. Under normal conditions, most 12-volt automatic battery chargers will work on most standard battery technologies; including Lead-acid, EFB, AGM and Gel. Many newer battery chargers have settings specifically for AGM batteries.

The technology of an AGM battery is not the same as a Gel battery, which has its own charging requirements. If your charger offers different modes, select the correct one for your battery. If you use the settings for a Gel battery to charge an AGM battery, your AGM battery will not charge fully and could become damaged.

**IMPORTANT**

Make sure that the positive (+) terminal of the charger is connected to the positive (+) terminal of the battery and the negative (-) terminal of the charger to the negative (-) terminal of the battery.

## When and how to charge your battery

(AGM, Calcium Lead-acid Battery and Industrial Maintainable Battery)



### Preparation before charging

Charging the battery in the vehicle is simpler and preferable for safety reasons, although this may not always be possible. Ensure there is good ventilation when charging in enclosed spaces. If you are removing the battery from the engine compartment to charge, a second person should help lift the battery if it is large and heavy.

#### IMPORTANT

With Lead-acid batteries, the formation of explosive hydrogen and degassing should be expected during charging. In extreme cases, a high concentration of hydrogen may result in an explosion, causing serious injuries and damage.

Battery defects should also be noted. Battery fluid may leak from damaged batteries, and physical contact with battery fluid can cause serious burns. The affected area must be rinsed thoroughly with clean water and seek medical help immediately.

When may the battery require charging?

- ✓ When the battery has been stored for a period of 3 months or longer
- ✓ When the voltage of the battery falls below 12.5V
- ✓ When the State of Charge (S.O.C.) indicator shows "black" or "clear"

Please exercise safety precautions when charging, refer to page 4.

### Checking terminal voltage

The terminal voltage should be checked six months after the date of manufacture. If the voltage has dropped below 12.5V, the battery needs to be recharged to between 12.7V and 12.8V before being stored further.

### Measuring terminal voltage

The terminal voltage is best measured with a Digital Multi-meter (1 mV resolution) at a room temperature of approximately 20°C.

### Recharging and charger capacity recommendations

If the terminal voltage drops below 12.5V, the battery must be recharged. The recommended charge current equates to 10% of the battery's nominal capacity (e.g. 8A for a battery with a nominal capacity of 80Ah). How long the battery should be recharged for depends on how it will be used.

If the battery is to be installed immediately:

A short recharging period is generally sufficient (i.e. terminal voltage to be a minimum of 12.5V, measured around one hour after the recharging period is complete).

If the battery is being returned to storage:

A maximum charge is required. A 44Ah battery with a terminal voltage of 12.45V can be charged to approximately 100% in 2.7 hours with a recommended charge current of 4.4A — equal to 10% of the battery's nominal capacity.

The charging time falls proportionately with the rise in the current the battery can supply (e.g. when the charge current is doubled to 8.8A, the charging time is reduced by half to 1.35 hours). The terminal voltage should always be checked again at least one hour after recharging.

Please remember to avoid overcharging as it can lead to permanent battery damage.

## Charging methods

### Constant voltage charging

Constant voltage charging is the most common charging method employed today. This method of charging generates a constant voltage from the charger, gradually reducing the current that enters the battery throughout the charging process. Unlike the method of applying constant current, there is no need to worry about charging currents and charging time.

This method is most appropriate for maintenance-free batteries. To prevent overcharging of the battery, pay careful attention to the charging current and the charging time. After charging is completed, please ensure the power is turned off.

Parameters for Calcium Lead-acid:

1. Charging Voltage: 15.5V
2. Charging Current: Maximum 25A
3. Charging Time: 20 Hours – 24 Hours
4. Float Charge: 13.4V at 25°C  
Compensation per cell of approximately -3.9 mV per °C (respectively -2.17 mV per °F) of temperature rise is necessary
5. Charging Voltage (when the battery is in the car):  
14.1V ~ 14.5V between 20°C ~ 30°C  
13.5V ~ 16.0V between -30°C ~ 60°C

Parameters for AGM:

1. Charging Voltage: 13.9V – 14.75V
2. Charging Current: Maximum 15A
3. Charging Time: Maximum 13 Hours
4. Float Charge: 13.4V at 25°C  
Compensation per cell of approximately -3.9 mV per °C (respectively -2.17 mV per °F) of temperature rise is necessary
5. Charging Voltage (when the battery is in the car):  
14.1V ~ 14.5V between 20°C ~ 30°C but it may vary depending on OE manufacturers' energy design  
13.5V ~ 15.5V between -30°C ~ 60°C

| Charging Voltage (V) |        |         |                     |
|----------------------|--------|---------|---------------------|
| Temperatures (°C)    | Normal | Maximum | Charging Time (Hrs) |
| 38 ~ 43              | 13.9   | 14.2    | Maximum 13          |
| 38 ~ 38              | 14.0   | 14.3    |                     |
| 27 ~ 32              | 14.1   | 14.4    |                     |
| 21 ~ 27              | 14.3   | 14.6    |                     |
| 16 ~ 21              | 14.45  | 14.75   |                     |

When a battery's voltage falls below 12.1V, it can be difficult to recharge it and recover optimal performance. This is especially so after a long time has elapsed. Any battery with a voltage of 12.1V or lower may not recharge to the same level required for vehicle use.

### Constant current charging

Constant current charging is the least common charging method employed today. This method of charging applies a constant current in amperes (A) to raise the battery voltage. Pay careful attention to the charge current and charging time to prevent overcharging the battery. After charging is complete, be sure to turn off the switch.

Parameters for Calcium Lead-acid:

1. Constant Current Charging: Low current, long charge time
2. Charging Current (A): 10% ~ 20% current of 20 hour capacity<sub>1</sub>
3. Charging Ampere Hours (Ah): Ampere Hours discharged<sub>2</sub>
4. Charging Time (Hours):  $[\text{Ampere Hours}_2 \div \text{Charging Current}_1] \times 1.2 \sim 1.5$  (Efficiency)

Parameters for AGM:

| Charging Current (A) | OCV (V)       | Charging Time (Hrs) | Remarks  |
|----------------------|---------------|---------------------|--|
| LN1: 2.5             | 12.76 ~ 12.86 | 2                   | For use in good condition, it is recommended to charge batteries before usage.                                   |
| LN2: 3.0             | 12.66 ~ 12.75 | 3.5                 |  |
| LN3: 3.5             | 12.56 ~ 12.86 | 3.5                 |  |
| LN4: 4.0             | 12.46 ~ 12.55 | 6                   |  |
| LN5: 4.75            | 12.36 ~ 12.45 | 7.5                 | Do not keep batteries under 12.35V for long periods of time. They are susceptible to becoming deeply discharged. |
| NS40: 1.75           | 12.26 ~ 12.35 | 8.5                 |  |
| NS60: 2.25           | 12.16 ~ 12.25 | 10                  |  |
|                      | 12.06 ~ 12.15 | 11                  |  |

Charging is complete when:

- ✓ The State of Charge (S.O.C.) indicator turns green
- ✓ The voltage level consistently reflects readings of above 16V at least twice or more

#### PLEASE NOTE

In the event that the battery is left discharged below 12.1V for a long period of time, recharging may be impossible as the polar plate is made of non-rechargeable material. Therefore, recharging immediately is always recommended.

Parameters for Calcium Lead-acid:

| State of Charge (%) | OCV (V) |
|---------------------|---------|
| 100                 | 12.78   |
| 85                  | 12.65   |
| 65                  | 12.47   |
| 50                  | 12.32   |
| 25                  | 12.07   |
| 0                   | 11.78   |

Parameters for AGM:

| State of Charge (%) | OCV (V) |
|---------------------|---------|
| 100                 | 12.96   |
| 80                  | 12.71   |
| 60                  | 12.44   |
| 40                  | 12.16   |
| 20                  | 11.87   |
| 0                   | 11.51   |



Charging method for Calcium Lead-acid batteries (according to temperature):

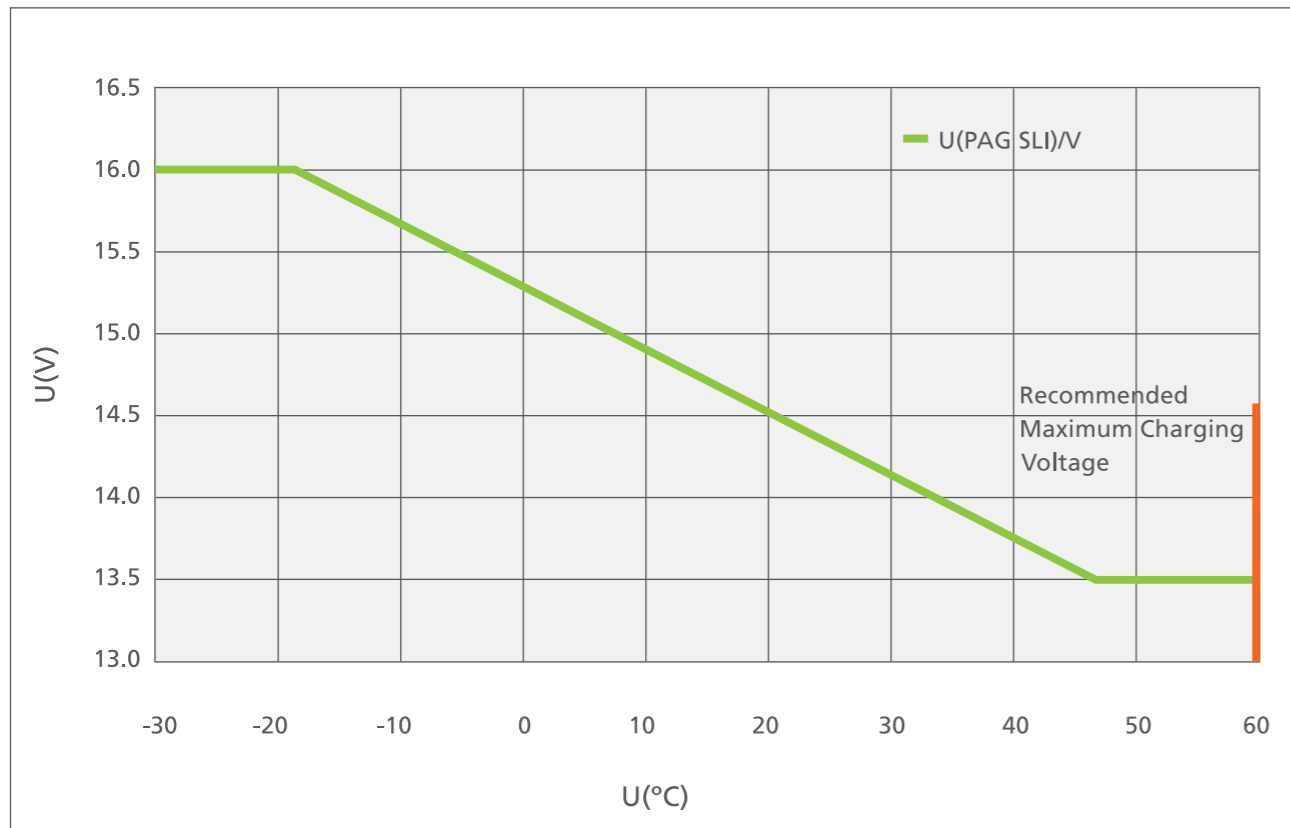

Charging instructions:

Use Constant Voltage Charging method to prevent overcharging.

Charging Voltage (when the battery is in the car)

SLI: 14.1V ~ 14.5V between 20°C ~ 30°C

3.5V ~ 16V between -30°C ~ 60°C

Parameters for Industrial Calcium Lead-acid batteries:

Charging method:

During normal conditions, the battery will be in charging mode. In the event of a power shortage, the battery will be in floating charging mode. In times of emergency, the battery can be used for Uninterrupted Power Supply (UPS) and communication facilities instead of electrical power.

Every 1 to 6 months, equalizing charging is required:

1. Floating Charging: 13.5V or 2.17V/cell (need to compensate by surrounding temperature)
  - 0°C ~ 15°C: 13.5V ~ 13.8V
  - 16°C ~ 25°C: 13.2V ~ 13.5V
  - 26°C ~ 50°C: 12.9V ~ 13.2V
2. Equalizing Charging Voltage: 15.5V or 2.7V/cell

Recommended operating condition:

1. Operating Temperature
  - i. Operating temperature: 0°C + 40°C (optimum temperature 20°C ± 5°C)
  - ii. Optimum surrounding temperature: 10°C ~ 25°C
  - iii. Storage temperature: -20°C + 60°C
2. Humidity Range: 30% ~ 90%
3. Altitude: Below 1000m
4. Installation Area: Indoor dust-free environment which does not contain toxic gas

Installation and maintenance of Industrial Calcium Lead-acid batteries:

1. Ensure installation area is well-ventilated with no risk of flooding
2. Ensure installation area is clean, with temperature maintained at 0°C ~ 40°C (optimum temperature: 20°C ~ 25°C)
3. Ensure battery terminal and connector are clean before installation.
  - Ensure terminals are fastened securely by applying force when connecting bolts. Loose connection may result in improper charging

Terminal fastening method:

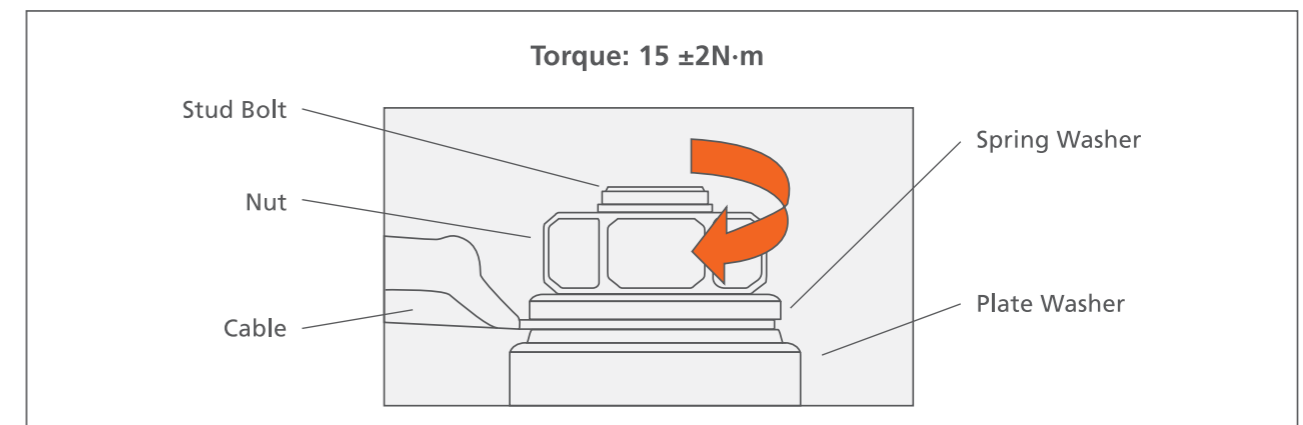

Caution:

- \* Use the spring washer when fastening the terminal
- \* Terminal connection strength setting: 15 ± 2N·m
- \* Inspect terminal connection once a month. If the terminal is loose, the terminal portion may melt and sink due to sparks, causing danger to surrounding areas



Charging method for Golf Cart batteries:

Always follow the safety instructions from the Golf Cart manual when maintaining the battery

Charging instructions:

- Follow the charger device instructions for cable management
- Check that the electrolyte level is above the plates, otherwise refill with deionized or distilled water — maximum limit is 10mm below bottom vent barrel
- Periodical equalization once every 30 days can help to extend battery life

| Details for GC2-XHD-UTL and GC8-HD-XTL |   |
|--|---|
| Qualification                          | Charge 1 minute to maximum 5A   |
| Bulk                                   | Charge to 25A to maximum 2.45V/cell ± 0.05V/cell                                  |
| Absorption                             | Taper current from 25A to 4.5A with a constant voltage of 2.45V/cell ± 0.05V/cell |
| Finish Phase                           | Charge at 4.5A to complete 115% – 118% Ampere Hours (Ah) from last discharge      |
| Top-up                                 | Maximum 9A for 4 hours  |

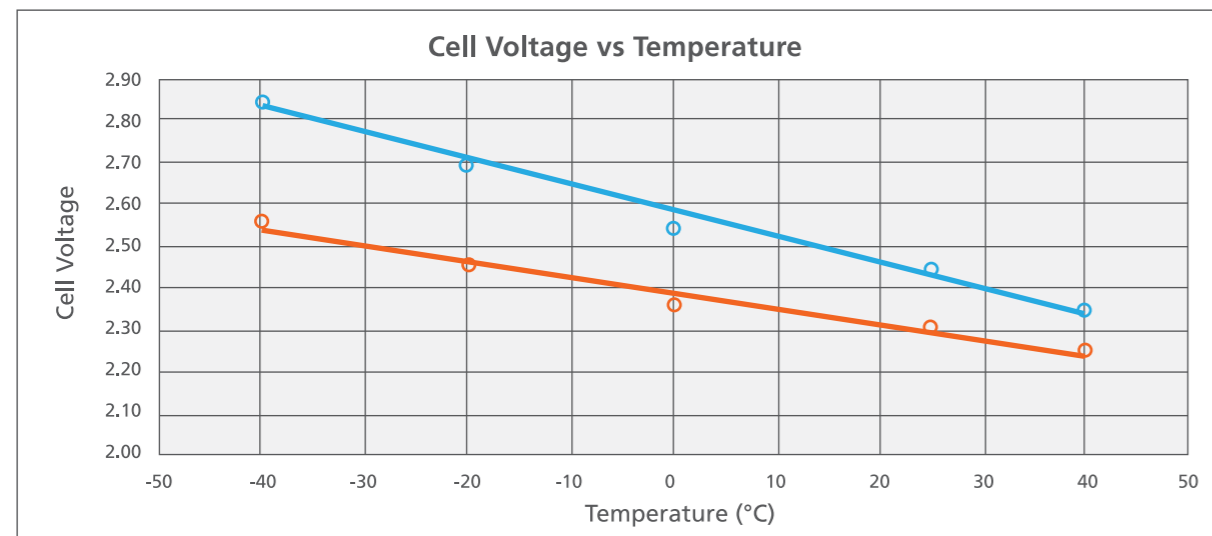
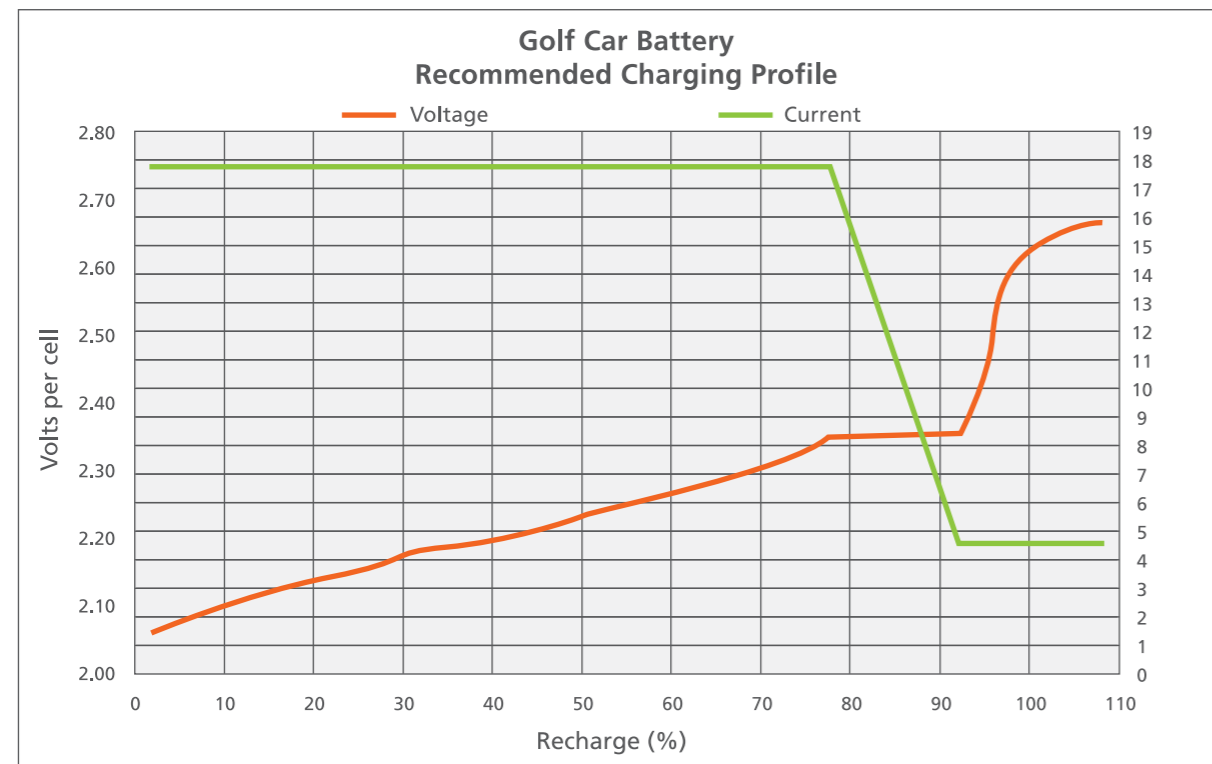

| Battery status               | -40°C (-40°F)       | -20°C (-4°F)        | 0°C (32°F)          | 25°C (77°F)         | 40°C (104°F)        |
|------------------------------|---------------------|---------------------|---------------------|---------------------|---------------------|
| Voltage limit on recharge    | 2.85V/cell          | 2.70V/cell          | 2.55V/cell          | 2.45V/cell          | 2.35V/cell          |
| Float voltage at full charge | 2.55V/cell or lower | 2.45V/cell or lower | 2.35V/cell or lower | 2.30V/cell or lower | 2.30V/cell or lower |

| Battery type | Charge temperature          | Discharge temperature       | Charge advisory  |
|--------------|-----------------------------|-----------------------------|--|
| Lead-acid    | -20°C – 50°C (-4°F – 122°F) | -20°C – 50°C (-4°F – 122°F) | Charge at 0.3°C or less below freezing<br>Lower V-threshold by 3mV/°C when hot |

Permissible temperature limits for various batteries. Batteries can be discharged over a large temperature range, but the charge temperature is limited. For best results, charge between 10°C and 30°C (50°F and 86°F). Lower the charge current when cold.

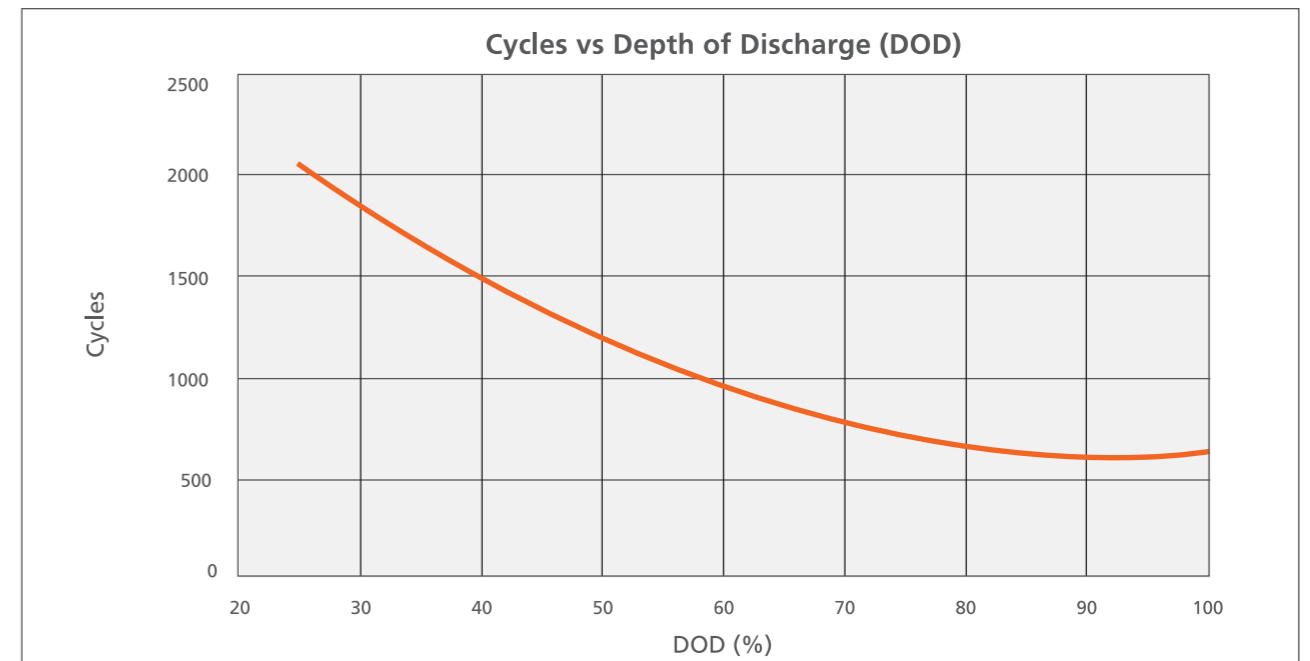

This is applicable assuming proper battery recharge procedures and maintenance is carried out, and no harmful contaminants are introduced to the system via addition of water.

## Battery replacement

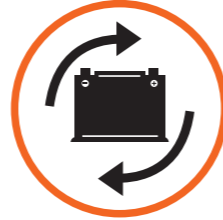

Please refer to your vehicle owner's manual for steps to replace your battery or replace using the steps below. Do NOT use any other tool as it may damage and short-circuit the battery. Do not use a battery smaller than the one currently installed.

### Safety precautions when replacing the battery

1. Always turn off the car engine before replacing the battery
2. Mark the positions of the terminals beforehand, so as to position the battery correctly
3. When removing the terminals, always remove the grounded terminal first to prevent short-circuiting
4. If the installation rack and cables are corroded, conduct repairs before attempting installation
5. It is easy for the cable terminals to become corroded due to the sulfuric acid present in battery fluid. Should corrosion occur, remove with fine sandpaper or a steel brush before attempting installation
6. Keep the removed battery out of reach of children and dispose according to local regulations.

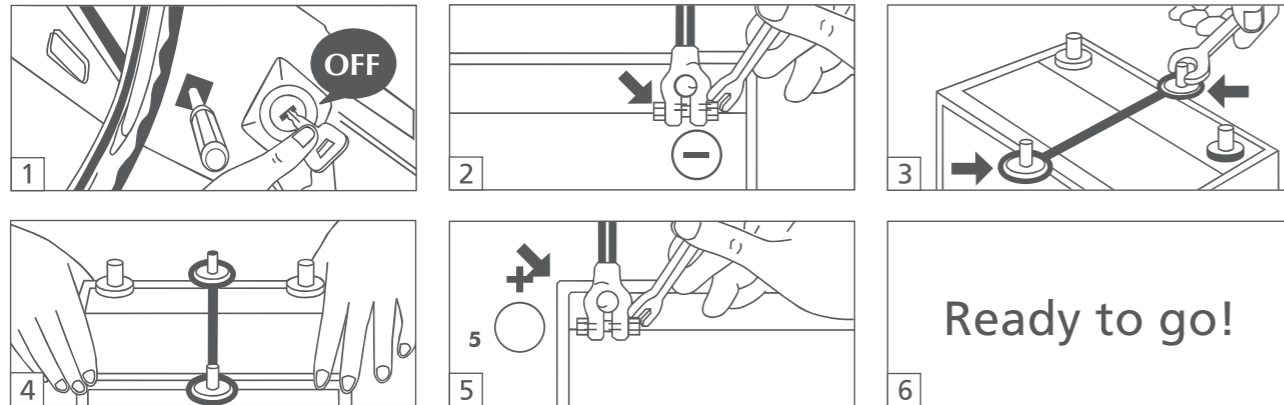

1. Turn off the engine and extract the key
2. When replacing the battery, remove cables from the negative (-) terminal first, followed by the positive (+) terminal of the battery
3. Unfasten the bolts of the installation rack and remove the old battery
4. Place the new battery on the installation rack and tighten the bolts. Press down firmly with your hands to ensure that the battery is secured in place
5. When connecting cables, connect it to the (+) terminal first, followed by the (-) terminal of the new battery

## How to jump-start your car battery

Safety precautions:

1. Always protect your eyes and hands from the battery
2. Do not attempt to jump-start a damaged battery
3. Do not touch the car and make sure that the ignition of both cars is turned off

Using jumper cables:

1. Connect the (+) cable to the (+) terminal of the dead battery
2. Connect the tip of the same cable to the (+) terminal of the new battery
3. Connect the other cable (earth cable) to the (-) terminal of the new battery
4. Connect the earth cable to the engine block or chassis of the dead car
5. Start the engine and then remove the cables in the reverse order in which they were connected

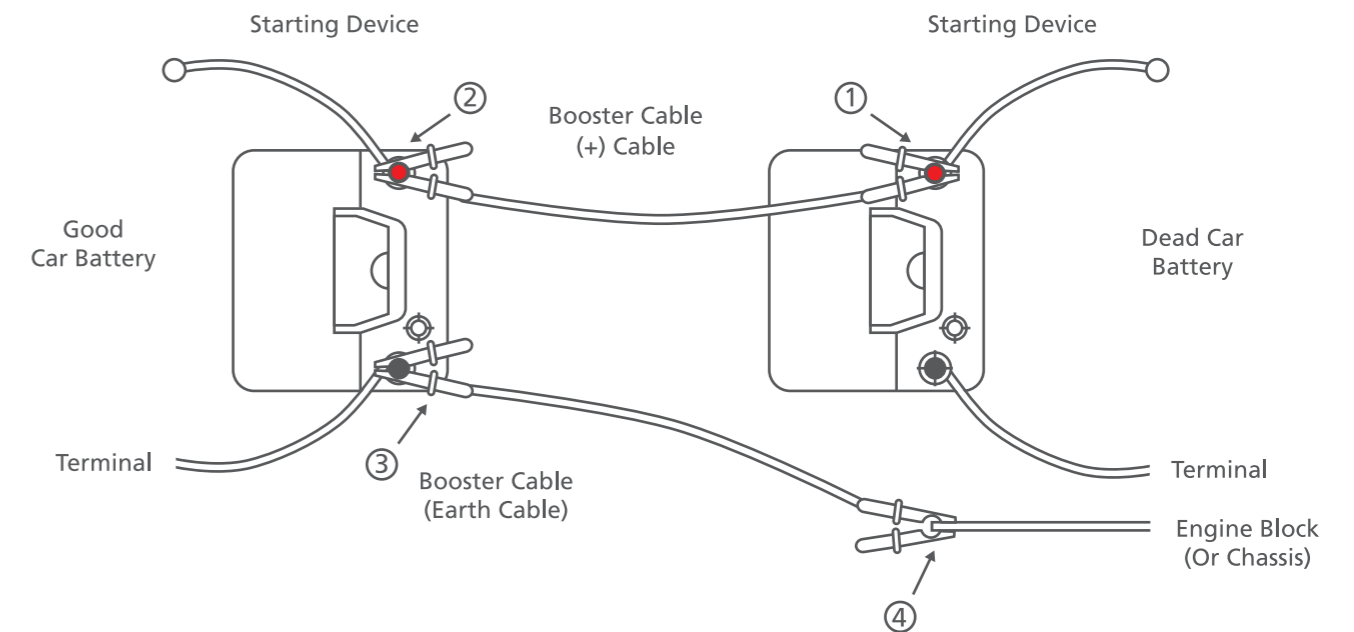

This manual contains information confidential and proprietary to Delkor® brand. The information may not be used, disclosed or reproduced without the prior written authorization from Delkor brand, and those so authorized may only use the information for purposes consistent with the authorization. Delkor is a registered trademark of Delkor brand. All use of the trademark requires the explicit written approval of Delkor brand, which may be revoked at any time. Any permission granted by Delkor brand to use the trademark only allows the use of the trademark in accordance with the guidelines given.