

Lay-in duct, screwed cover

- Quick Features :**
- Rounded corners
 - Complete system
 - Powder coating



Visit www.eurobex.com for details.

Call us toll free 1-800-363-2423

The 1100 series lay-in ducts are made of code gauge steel and designed to permit fast and easy installation of multiple wire runs. The corners of components are rounded. The covers are secured by screws. Knockouts are provided on two sides of the body. Also available without knockouts

(add suffix "N" to the catalog number). All accessories for a complete system such as 22½°, 45° and 90° elbows, crosses, T's, reducers, telescope fittings have removable covers. Joiner plates are linked by carriage bolts and anti-vibration nuts which can be installed using minimum tooling.

All of the painted components are finished with heat fused polyester powder, electrostatically applied on a phosphatized base. Finish is ANSI/ASA 61 gray. (other colors available)

CSA Certified
NEMA 1 / IP20

DESCRIPTION	CATALOG NUMBER					
	2½" X 2½"	4" X 4"	6" X 6"	8" X 8"	10" X 10"	12" X 12"
Straight sections 12"	1100 SS2012SC	1100 SS4012SC	1100 SS6012SC	1100 SS8012SC	1100 SS10012SC	1100 SS12012SC
Straight sections 24"	1100 SS2024SC	1100 SS4024SC	1100 SS6024SC	1100 SS8024SC	1100 SS10024SC	1100 SS12024SC
Straight sections 36"	1100 SS2036SC	1100 SS4036SC	1100 SS6036SC	1100 SS8036SC	1100 SS10036SC	1100 SS12036SC
Straight sections 48"	1100 SS2048SC	1100 SS4048SC	1100 SS6048SC	1100 SS8048SC	1100 SS10048SC	1100 SS12048SC
Straight sections 60"	1100 SS2060SC	1100 SS4060SC	1100 SS6060SC	1100 SS8060SC	1100 SS10060SC	1100 SS12060SC
Straight sections 72"	1100 SS2072SC	1100 SS4072SC	1100 SS6072SC	1100 SS8072SC	1100 SS10072SC	1100 SS12072SC
Straight sections 120"	1100 SS2120SC	1100 SS4120	1100 SS6120	1100 SS8120	1100 SS10120	1100 SS12120
Screw on barrier 12"	1100 BA2012	1100 BA4012	1100 BA6012	1100 BA8012	1100 BA10012	1100 BA12012
Screw on barrier 24"	1100 BA2024	1100 BA4024	1100 BA6024	1100 BA8024	1100 BA10024	1100 BA12024
Screw on barrier 36"	1100 BA2036	1100 BA4036	1100 BA6036	1100 BA8036	1100 BA10036	1100 BA12036
Screw on barrier 48"	1100 BA2048	1100 BA4048	1100 BA6048	1100 BA8048	1100 BA10048	1100 BA12048
Screw on barrier 60"	1100 BA2060	1100 BA4060	1100 BA6060	1100 BA8060	1100 BA10060	1100 BA12060
Screw on barrier 72"	--	1100 BA4072	1100 BA6072	1100 BA8072	--	--
Screw on barrier 120"	1100 BA2120	1100 BA4120	1100 BA6120	1100 BA8120	1100 BA10120	1100 BA12120
Telescope fitting	1100 TL2068	1100 TL4068	1100 TL6068	1100 TL8068	1100 TL10068	1100 TL12068
Elbow 90 degrees	1100 EL2090	1100 EL4090	1100 EL6090	1100 EL8090	1100 EL10090	1100 EL12090
Elbow 45 degrees	1100 EL2045	1100 EL4045	1100 EL6045	1100 EL8045	1100 EL10045	1100 EL12045
Elbow 22½ degrees	1100 EL2022	1100 EL4022	1100 EL6022	1100 EL8022	1100 EL10022	1100 EL12022
Elbow sweep 90 degrees	1100 ES2091	1100 ES4091	1100 ES6091	1100 ES8091	--	--
Tee fitting	1100 TF2062	1100 TF4062	1100 TF6062	1100 TF8062	1100 TF10062	1100 TF12062
Cross fitting	1100 CF2063	1100 CF4063	1100 CF6063	1100 CF8063	1100 CF10063	1100 CF12063
Reducer 4"X4" to 2½"X2½"	--	1100 RD4402	--	--	--	--
Reducer 6"X6" to 4"X4"	--	--	1100 RD6604	--	--	--
Reducer 8"X8" to 6"X6"	--	--	--	1100 RD8806	--	--
Reducer 10"X10" to 8"X8"	--	--	--	--	1100 RD101008	--
Reducer 12"X12" to 8"X8"	--	--	--	--	--	1100 RD121208
Reducer 12"X12" to 10"X10"	--	--	--	--	--	1100 RD121210
Joiner (Coupling)	1100 JO2067	1100 JO4067	1100 JO6067	1100 JO8067	1100 JO10067	1100 JO12067
Bracket hanger	1100 HD2069	1100 HD4069	1100 HD6069	1100 HD8069	1100 HD10069	1100 HD12069
Drop hanger	1100 HD2069	1100 HD4069	1100 HD6069	1100 HD8069	1100 HD10069	1100 HD12069
Support hanger	1100 HS2070	1100 HS4070	1100 HS6070	1100 HS8070	1100 HS10070	1100 HS12070
Closing plate	1100 CP2065	1100 CP4065	1100 CP6065	1100 CP8065	1100 CP10065	1100 CP12065
Open adaptor	1100 OA2071	1100 OA4071	1100 OA6071	1100 OA8071	1100 OA10071	1100 OA12071
Adaptor (Box connector)	1100 AD2066	1100 AD4066	1100 AD6066	1100 AD8066	1100 AD10066	1100 AD12066

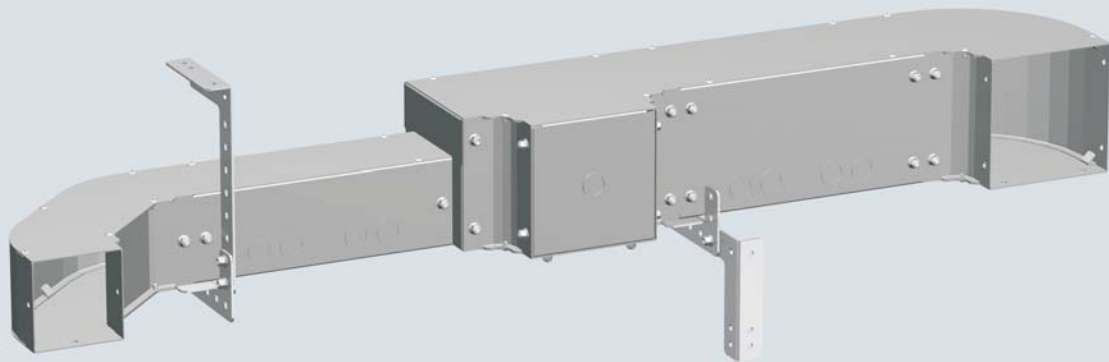

Data subject to change without notice.

Suggested Accessories



p.368

NEMA 1 WIREWAY

1100 DUCTS

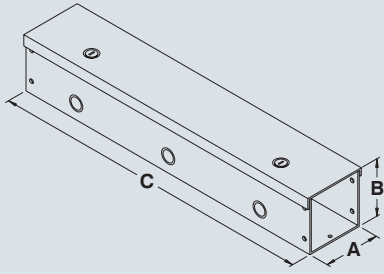

Straight section

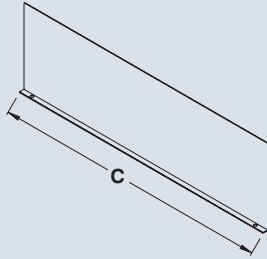

Screw-on barrier

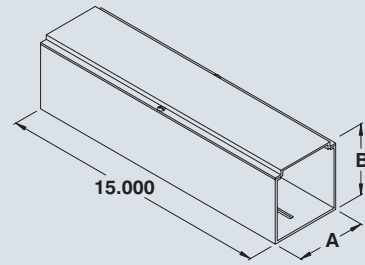

Telescope fitting

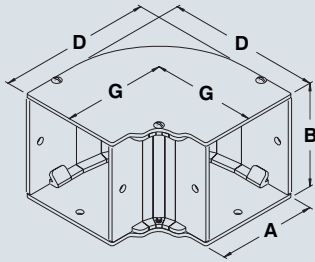

Elbow 90 degrees

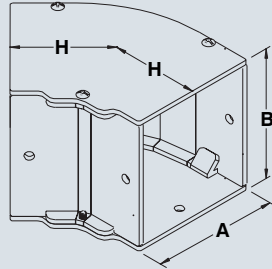

Elbow 45 degrees

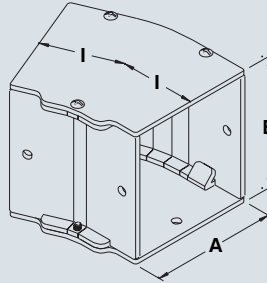

Elbow 22½ degrees

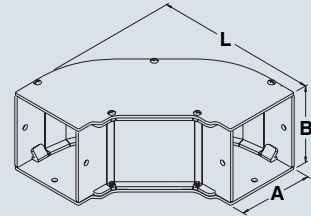

Elbow sweep 90 degrees

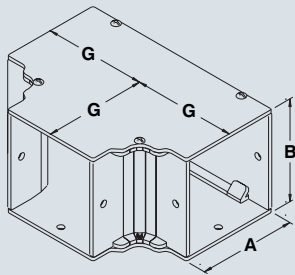

Tee fitting

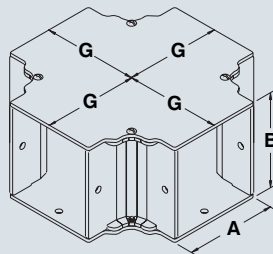

Cross fitting

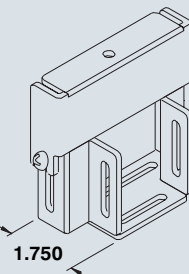

Reducer

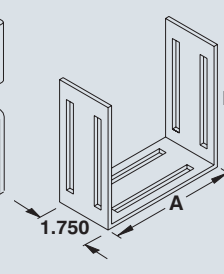

Joiner plate

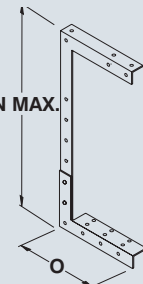

Bracket Hanger

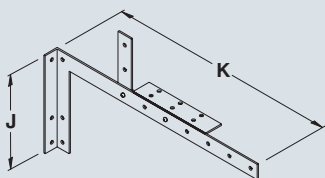

Drop hanger

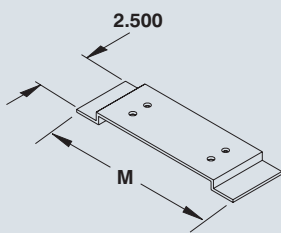

Support hanger

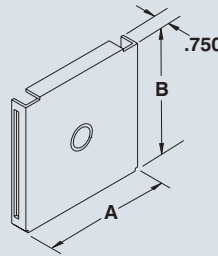

Closing plate

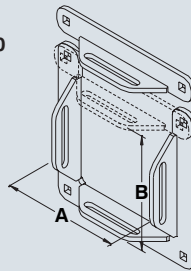

Open Adaptor

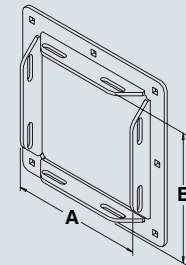

Adaptor

DIMENSIONS

A	B	C	D	F	G	H	I	J	K	L	M	N	O
2.500	2.500	12-24-36-48-60-72-120	4.687	2.500	3.437	2.500	2.250	4.000	7.000	7.906	4.500	12.000	4.750
4.000	4.000	12-24-36-48-60-72-120	6.187	2.656	4.187	2.812	2.406	6.000	8.500	9.406	6.000	15.000	6.250
6.000	6.000	12-24-36-48-60-72-120	8.187	3.312	5.187	3.250	2.406	8.000	10.500	11.406	8.000	19.000	8.250
8.000	8.000	12-24-36-48-60-72-120	10.187	3.656	6.187	3.656	2.750	8.000	12.500	13.406	10.000	23.000	10.250
10.000	10.000	12-24-36-48-60-72-120	12.187	4.000	7.187	4.062	3.000	8.000	14.500	15.406	12.000	27.000	12.250
12.000	12.000	12-24-36-48-60-72-120	14.187	4.625	8.187	4.500	3.187	8.000	16.500	17.406	14.000	31.000	14.250

Data subject to change without notice.

NEMA 1 WIREWAY

1100 DUCTS

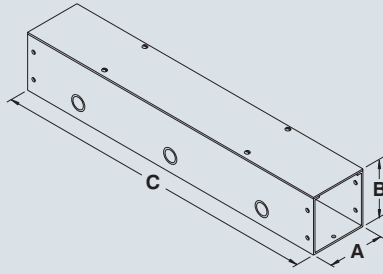

Straight section

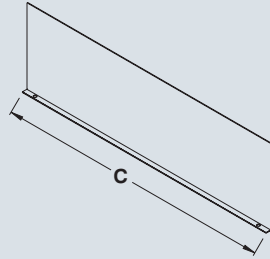

Screw-on barrier

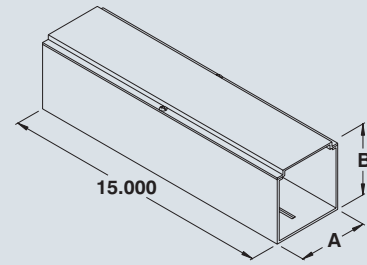

Telescope fitting

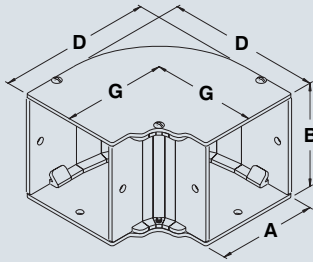

Elbow 90 degrees

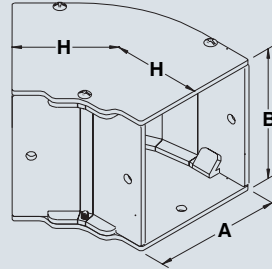

Elbow 45 degrees

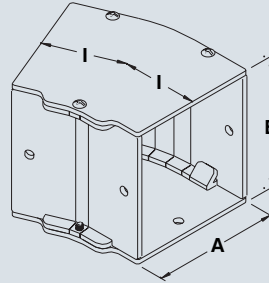

Elbow 22½ degrees

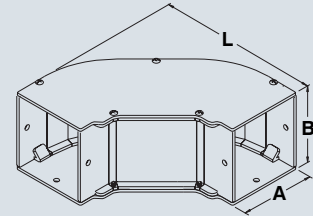

Elbow sweep 90 degrees

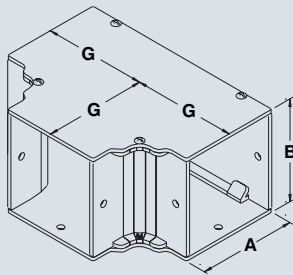

Tee fitting

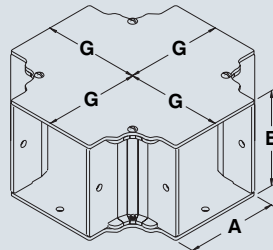

Cross fitting

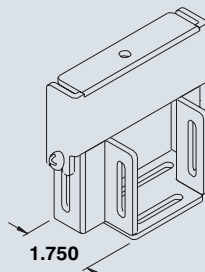

Reducer

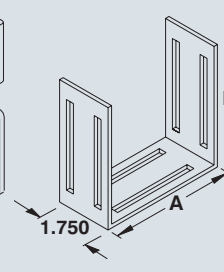

Joiner plate

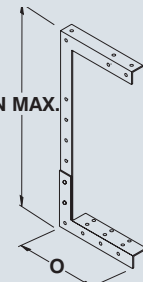

Bracket Hanger

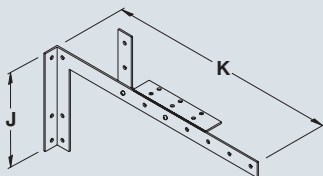

Drop hanger

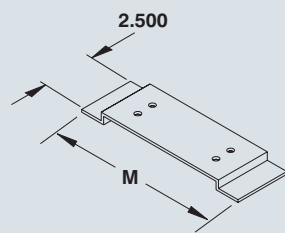

Support hanger

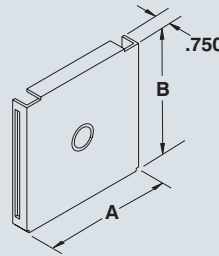

Closing plate

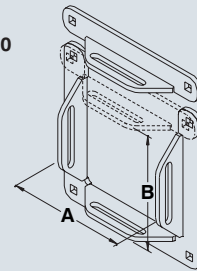

Open Adaptor

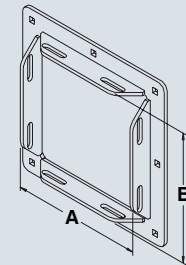

Adaptor

DIMENSIONS

A	B	C	D	F	G	H	I	J	K	L	M	N	O
2.500	2.500	12-24-36-48-60-72-120	4.687	2.500	3.437	2.500	2.250	4.000	7.000	7.906	4.500	12.000	4.750
4.000	4.000	12-24-36-48-60-72-120	6.187	2.656	4.187	2.812	2.406	6.000	8.500	9.406	6.000	15.000	6.250
6.000	6.000	12-24-36-48-60-72-120	8.187	3.312	5.187	3.250	2.406	8.000	10.500	11.406	8.000	19.000	8.250
8.000	8.000	12-24-36-48-60-72-120	10.187	3.656	6.187	3.656	2.750	8.000	12.500	13.406	10.000	23.000	10.250
10.000	10.000	12-24-36-48-60-72-120	12.187	4.000	7.187	4.062	3.000	8.000	14.500	15.406	12.000	27.000	12.250
12.000	12.000	12-24-36-48-60-72-120	14.187	4.625	8.187	4.500	3.187	8.000	16.500	17.406	14.000	31.000	14.250

Data subject to change without notice.