

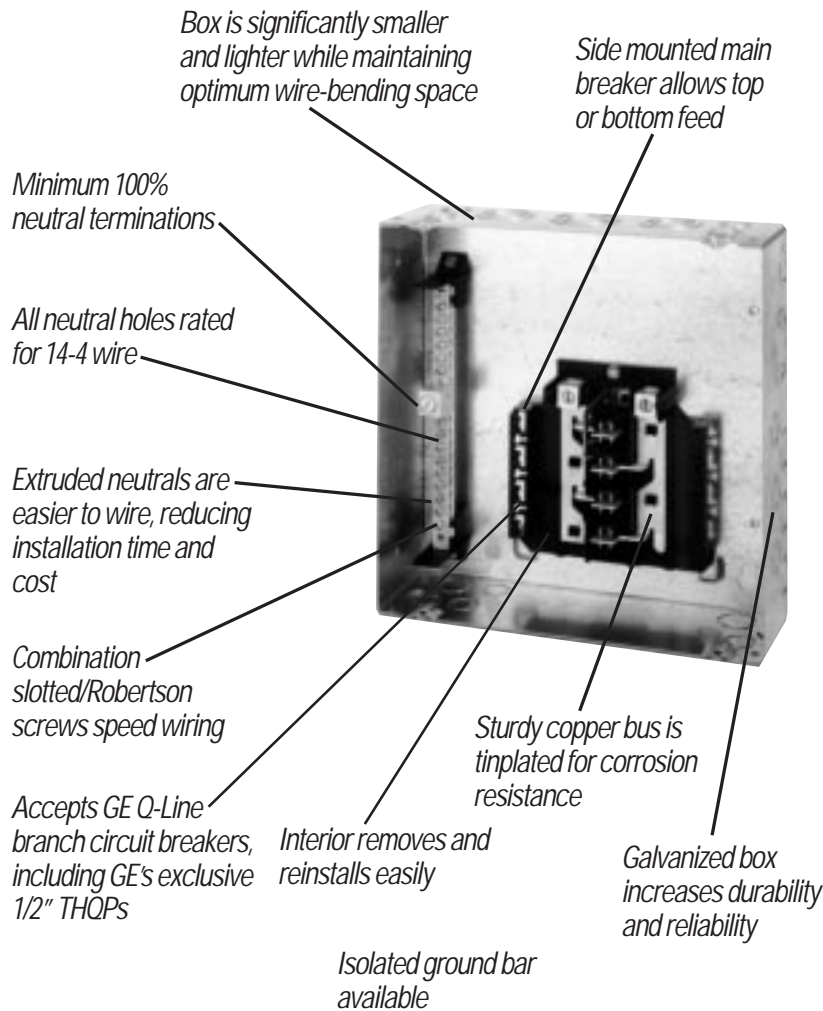

PowerMark Gold™ Load Centers

Single Phase, 40-125A, 2-8 circuits

- Sturdy copper bus and galvanized box increase durability and reliability
- Reduces total cost through faster, easier installation; enhanced application flexibility; and reduced inventory requirements
- Solid neutrals allow quick, easy, secure terminations
- Easy main breaker installation on 6 and 8 circuit interiors (use retainer clip)



PowerMark Gold™ Load Center Selection Guide

Factory Installed Main Lugs – Field Convertible to Main Circuit Breaker (125A only, please order main breaker separately)*

Main Ampere Rating	Maximum Spaces				Total 1-pole Spaces	Indoor Flush Enclosure		Indoor Surface Enclosure		Outdoor Surface Mount	Main Wire Size	Equipment Ground Kit	Main Bkr Retainer Kit	Dimensions: (WxHxD)
	1" THQL	1/2" THQP	1p	2p		with door	without door	with door	without door					
40	2	1	4	1	4	-	-	-	TL240SCU	TL240RCU	6-3	TGK4	-	Indoor: 5 $\frac{1}{2}$ "x9 $\frac{1}{2}$ "x3 $\frac{1}{4}$ " Outdoor: 7 $\frac{1}{4}$ "x10"x3 $\frac{3}{4}$ "
70	2	1	4	1	4	-	-	-	TL270SCU	TL270RCU	6-3	TGK4	-	
125	6	3	12	4	12	TLM612FCUD	TLM612FCU	TLM612SCUD	TLM612SCU	TLM612RCU	6-1	TGK12	THQLRK2	11 $\frac{1}{2}$ "x11 $\frac{1}{8}$ "x3 $\frac{1}{4}$ "
125	8	4	16	6	16	TLM812FCUD	TLM812FCU	TLM812CUD	TLM812SCU	TLM812RCU	6-1	TGK12	THQLRK2	

* Suitable main breakers include THQL and THHQL at 100A or less

Wiring Diagrams

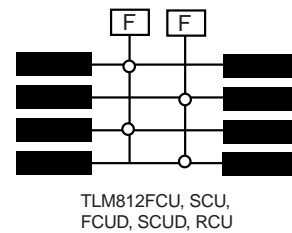
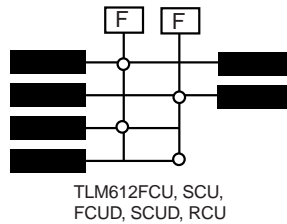
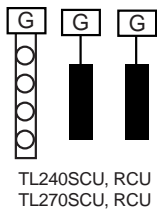

Terminal Symbol	PowerMark Gold Wire Range (AWG/kcmil)	
	CU	AL
F	6-1	6-1
G	6-3	6-3

Knockout Configurations and Dimensions

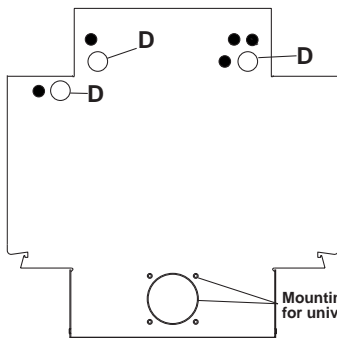

TLM612RCU
TLM812RCU

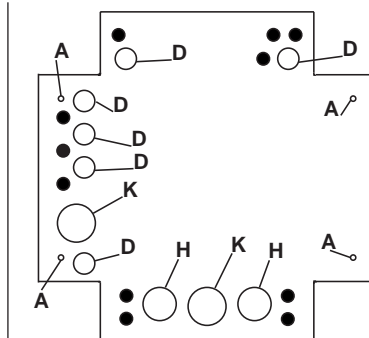

TLM612FCU TLM812FCUD TLM612SCUD
TLM812FCU TLM612SCU TLM812SCUD
TLM612FCUD TLM812SCU

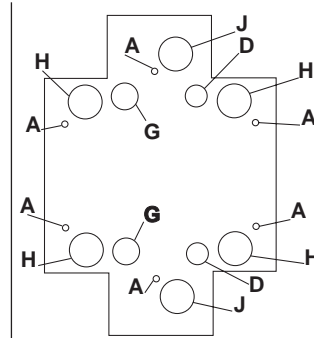

TL240SCU
TL270SCU

Symbol	A	•	D	G	H	J	K
Conduit Size (In.)	9/32	-	-	-	-	-	-
	-	3/8	-	-	-	-	-
	-	1/2	1/2	1/2	1/2	-	-
	-	-	3/4	3/4	3/4	3/4	3/4
	-	-	-	1	1	1	1
	-	-	-	1 1/4	1 1/4	1 1/4	1 1/4

References

DET-222 Residential Products Catalog

For more information, contact your local GE ED&C sales office or visit us on the web at www.ge.com/edc/components

Accessories & Options

- Door and handle
- Equipment ground kits (TGK12, TGK4)
- Front filler plates
- Handle locks
- Handle ties
- Hardware kits (THDWRKIT)
- Main breaker retainer kit (THQLRK2)
- Universal raintight hubs



GE Industrial Systems

General Electric Company
41 Woodford Avenue, Plainville, CT 06062
www.ge.com/edc

© 1998 General Electric Company