

### Large Capacity, Two-Piece Steel Surface Raceway

6000® Series Raceway can be used divided for separate wiring circuits or multi-service applications. For large cabling installations, 6000 can be used undivided as headers and feeders or to bring wiring to a specified location. 6000 Series Raceway is ideal for all applications requiring a high cable capacity, dual service steel raceway. Commercial, institutional, and industrial applications all benefit from the 6000 Series rigid steel construction and durable Ivory ScuffCoat™ finish. 6000 Series Raceway is also ideal for municipalities that require either all steel construction or prohibit nonmetallic cable management systems.



6000® Series Raceway shown as a divided system with Activate inserts and power device with a 4050 device bracket.

#### FEATURES & BENEFITS

- **Steel raceway.** Provides superior strength for any dry interior location installation.
- **Extra large cross sectional area.** Provides space for large wiring requirements or installations that use large diameter cable for power and/or data/communications.
- **Dividable raceway base.** Snap-in divider creates two-compartment raceway. For bringing large amounts of power and data/communications cable to one location.
- **Complete line of fittings.** Provides complete wiring solution and allows for interconnection between raceway systems.
- **Gray baked enamel and Ivory ScuffCoat finish.** Enamel finish assures durability; can be easily overpainted. Durable Ivory ScuffCoat finish makes a scratch resistant surface.
- **Installs as a feeder or header raceway.** Ideal for overhead, open spaces and underfloor applications.
- **Accommodates large size devices.** Large size raceway accepts single- and dual-gang devices up to 100 amps and circuit breakers up to three pole.
- **Pre-cut covers for standard outlet center locations.** For mounting devices on various centers without cutting the

covers which reduces number of field cuts for labor savings.

- **Base and cover cutters.** Manually operated cutters are lightweight and portable. Cutters offer labor savings for any size job and maintain a factory clean and square cut.
- **Communication connectivity options.** Accepts industry standard and proprietary devices from a wide range of manufacturers to provide a seamless and aesthetically pleasing interface for voice, data, audio, and video applications at the point of use.
- **ADA compliant.** Raceway and fittings can be installed in conformance with ADA requirements.
- **UL Listed and CSA Certified.** Raceway UL file E4376 Guide RJBT, CSA file LR350. Fittings UL file 41751 Guide RJPR, CSA file 350 and 48952.



Download this product's PEP ecopassport® environmental product declaration at [www.legrand.us/resources-and-downloads](http://www.legrand.us/resources-and-downloads). This declaration conforms with ISO 14025 and 14040 and is in alignment with EN 15804.



4047 Series Faceplates accommodate a wide range of power and communications applications.

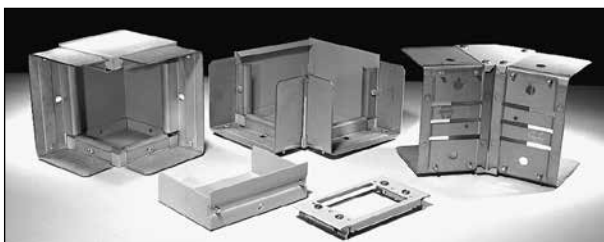

## 6000 Series Raceway System Layout

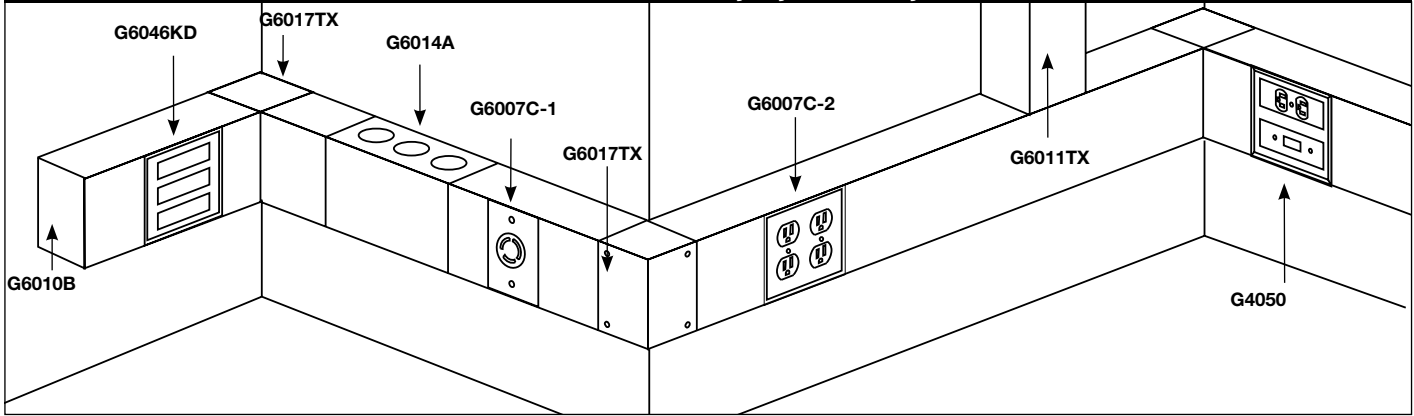

**NOTE:** Illustration is for showing single service product application only.

### 6000 Raceway Wire Fill Capacity for Power

WIRE SIZE THHN/THWN	O.D. inches (mm)		NUMBER OF CONDUCTORS (40% FILL)							
			WITHOUT DEVICES		WITH DUPLEX RECT. DEVICES 1.59 in. <sup>2</sup> (1025mm <sup>2</sup> )		WITH SURGE/ GFCI DEVICES 2.30 in. <sup>2</sup> (1485mm <sup>2</sup> )		LARGE SINGLE RECEPTACLES 3.00 in. <sup>2</sup> (1935mm <sup>2</sup> )	
			UNDIV.	DIVIDED	UNDIV.	DIVIDED	UNDIV.	DIVIDED	UNDIV.	DIVIDED
14 AWG	0.111	(2.8)	659	296	528	231	470	202	412	173
12 AWG	0.130	(3.3)	481	216	385	168	342	147	300	126
10 AWG	0.164	(4.2)	303	136	243	106	216	92	189	79
8 AWG	0.216	(5.5)	174	78	140	61	124	53	109	45
6 AWG	0.254	(6.5)	126	56	101	44	89	38	78	33
4 AWG	0.324	(8.2)	77	34	0	0	0	0	0	0
3 AWG	0.352	(8.9)	65	29	0	0	0	0	0	0
2 AWG	0.384	(9.8)	55	24	0	0	0	0	0	0
1 AWG	0.446	(11.3)	40	18	0	0	0	0	0	0
1/0 AWG	0.486	(12.3)	34	15	0	0	0	0	0	0
2/0 AWG	0.532	(13.5)	28	12	0	0	0	0	0	0

**NOTE:** For additional information, refer to the Technical Section of ED1560 (Product Guide).





### 6000 Raceway Cable Fill Capacities for Data/Communications

CABLE TYPE	CATEGORY / DESIGNATION	O.D. Inches (mm)	DIVIDED 40% FILL	UNDIVIDED 40% FILL
UNSHIELDED TWISTED PAIR	4-pair, 24 AWG Cat 3	0.190 (4.8)	101	225
	4-pair, 24 AWG Cat 5e	0.210 (5.3)	83	184
	4-pair, 24 AWG Cat 6	0.250 (6.3)	58	130
	4-pair, 24 AWG Cat 6a*	0.354 (9.0)	29	65
	25-pair, 24 AWG Cat 6	0.410 (10.4)	21	48
TELEPHONE	2-pair, 24 AWG	0.140 (3.6)	187	415
	3-pair, 24 AWG	0.150 (3.8)	163	362
	4-pair, 24 AWG	0.190 (4.8)	101	225
	25-pair, 24 AWG	0.410 (10.4)	21	48
COAXIAL	RG58/U	0.195 (5.0)	96	214
	RG59/U	0.242 (6.1)	62	139
	RG62/U	0.242 (6.1)	62	139
	RG6/U	0.270 (6.9)	50	111
TWINAXIAL	100 Ohm	0.330 (8.4)	33	74
SHIELDED TWISTED PAIR	TYPE 1	0.390 (9.9)	24	53
	TYPE 2	0.465 (11.8)	16	37
	TYPE 3	0.245 (6.2)	61	135
FIBER	Mini ZipCord	0.079 x 0.157 (2 x 4)	232	516
	ZipCord	0.118 x 0.236 (3 x 6)	103	230
	Round 4 Strand Fiber	0.187 (4.8)	104	233
	Round 6 Strand Fiber	0.256 (6.5)	55	124

**NOTE:** Capacity range is calculated at 20% to 40% of raceway area as stated in a proposed revision to the Commercial Building Standard for Telecommunication Pathways & Spaces, TIA/EIA-569. Actual wire fill capacity may vary based on applications, cable types, and number, as well as type of fittings. (Fitting may cause additional variances to the fill capacity.)

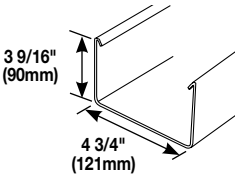
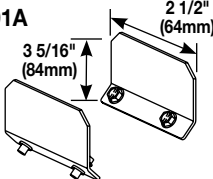
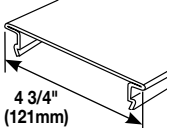
\* Category 6 augmented (6a) cable for 10 gigabit ethernet – max allowed cable diameter per addenda No. 11 ANSI TIA/EIA 568-B.2.

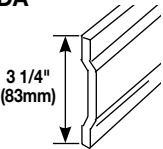
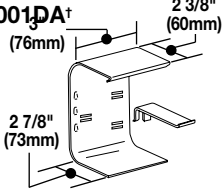
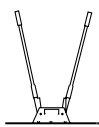
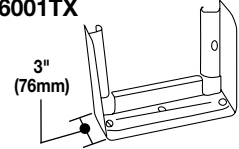
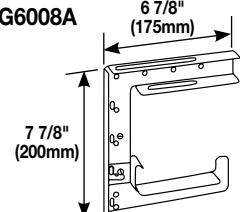
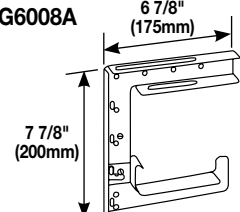
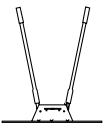
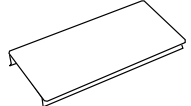
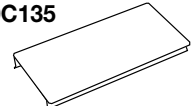
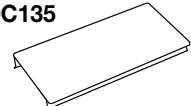
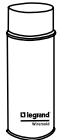
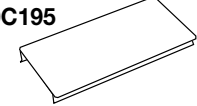
## 6000 Series Raceway Ordering Information

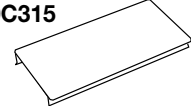
Catalog No./Item	Description/Specifications	Catalog No./Item	Description/Specifications
<b>V6000B-10</b> <b>G6000B010</b> 	<b>Base</b> – .060" (1.5mm) galvanized steel. Packed two 10' (3m) lengths per carton. Base has two 9/32" diameter trade size KOs 1 1/4" (32mm) from each end and on centers of approximately 18" (457mm) throughout.	<b>6001A</b> 	<b>Coupling</b> – For joining lengths of 6000B.
<b>V6000C*</b> <b>G6000C*</b> 	<b>Cover</b> – .040" (1.0mm) galvanized steel. Packed four 5' (1.5m) per carton.	<b>G6000WC</b> 	<b>Wire Clip</b> – For holding conductors in place. Use only with undivided 6000 Series Raceway.
<b>G6000DA**</b> 	<b>Divider</b> – .040" (1.0mm) galvanized steel. One side painted buff primer to provide identification of compartments. Packed four 5' (1.5m) lengths per carton.	<b>G6001DA†</b> 	<b>Divider Clip</b> – For holding G6000DA Divider in place to divide raceway into 1/3, 1/2, or 2/3 compartments. 6000 Raceway divided into 1/3 compartments will not accept devices.
<b>660B</b> 	<b>Base Cutter</b> – Portable base cutter. Steel constructed provides clean and easy square cuts. Manual operation required.	<b>G6001TX</b> 	<b>Converter Coupling</b> – For converting 6011TX or 6017TX into a tee or cross. For tee, one required; for cross, two required.
<b>660BDK</b> 	<b>Replacement Blade Kit</b> – Replacement blade and die set for 640B Cutter.	<b>G6008A</b> 	<b>C-Hanger</b> – For suspending 6000 or 4000 Raceway from structural ceiling. Designed for use with 3/8" (9.5mm) rod. Hangers should be installed no more than 4' (1.2m) apart along raceway run. Can be bolted back-to-back for dual runs of 4000, 6000, or to a G3008C for combined runs with 3000 Raceway.
<b>640C</b> 	<b>Cover Cutter</b> – Portable cover cutter. Steel constructed provides clean and easy square cuts. Manual operation required.	<b>V4000C075/ G4000C075*</b> 	<b>Pre-Cut Cover 7.5" (191mm)</b> – For mounting devices on 12" (305mm) centers with 4047 Series Cover Plates.
<b>640CDK</b> 	<b>Replacement Blade Kit</b> – Replacement blade and die set for 640C Cutter.	<b>V4000C135/ G4000C135</b> 	<b>Pre-Cut Cover 13.5" (345mm)</b> – For mounting devices on 18" (457mm) centers with 4047 Series Cover Plates.
<b>IWE-S</b> <b>GWE-S</b> 	<b>Spray Paint</b> – Used for touching up large areas. Contains 12 oz. of paint.  <b>NOTE:</b> Can only be shipped via ground transportation.	<b>V4000C195/ G4000C195</b> 	<b>Pre-Cut Cover 19.5" (495mm)</b> – For mounting devices on 24" (610mm) centers with 4047 Series Cover Plates.
<b>IWE-P</b> <b>GWE-P</b> 	<b>Touch-Up Paint Pen</b> – Used for touching up small areas. Contains 0.3 oz. of paint.	<b>V4000C315/ G4000C315</b> 	<b>Pre-Cut Cover 31.5" (800mm)</b> – For mounting devices on 36" (915mm) centers with 4047 Series Cover Plates.

\* 4000C and 6000C are compatible with 4000B and 6000B Raceway.

\*\* G6001DA Divider Clips are required to hold divider in place.

## 6000 Series Raceway Ordering Information

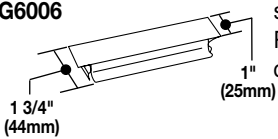
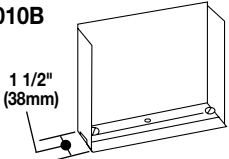
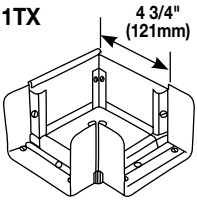
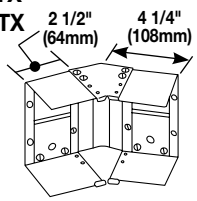
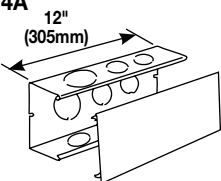
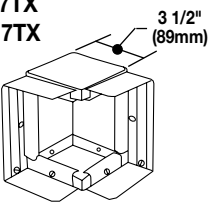
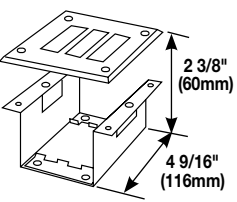



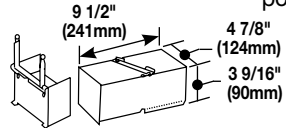
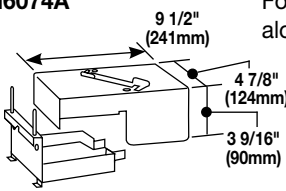
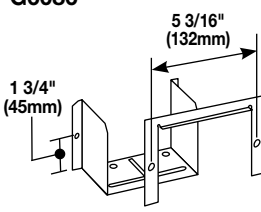
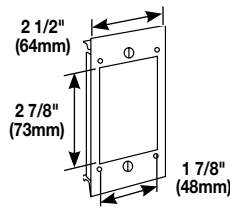
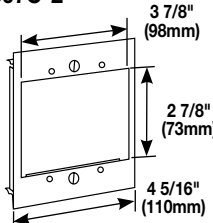







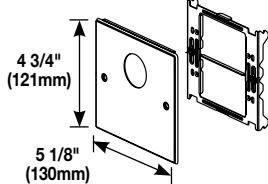
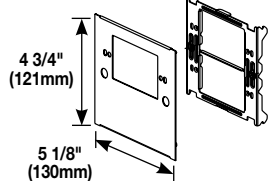
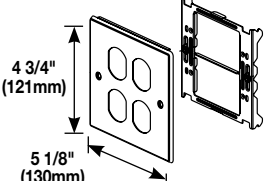
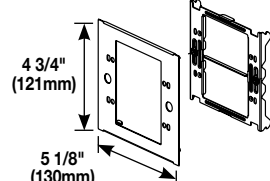

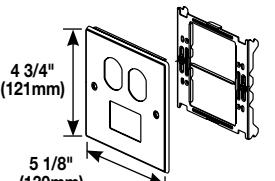
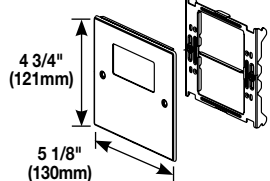
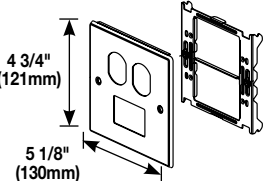
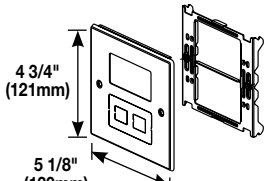

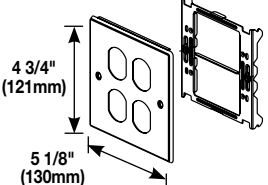

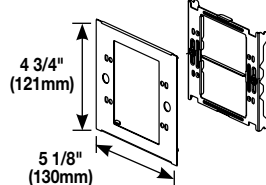

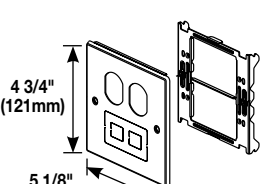
Catalog No./Item	Description/Specifications
<b>V6006</b> <b>G6006</b> 	<b>Connection Cover</b> – Use where two sections of 4000 or 6000 Series Raceway Cover, not squarely cut, come together.
<b>V6010B</b> <b>G6010B</b> 	<b>Blank End Fitting</b> – For closing open end of 6000 Series Raceway.
<b>V6011TX</b> <b>G6011TX</b> 	<b>Combination Flat Elbow</b> – For using as a flat elbow, tee, or cross, (one 6001TX required for tee; two for cross; not included).
<b>V6012TX</b> <b>G6012TX</b> 	<b>Internal or External 45° Elbow</b> – For making internal or external 45° turns in a run of 6000 Series Raceway. Can also be assembled as an inverted 45° elbow.
<b>V6014A</b> <b>G6014A</b> 	<b>Connector Fitting</b> – Has 1 1/4", 1 1/2" and 2" (32mm, 38mm and 51mm) trade size KOs in back and on each side.
<b>V6017TX</b> <b>G6017TX</b> 	<b>Combination Internal/External 90° Elbow</b> – For use as internal or external elbow, straight-through fitting, tee, or cross (one G6001TX required for tee or straight through fitting; two for cross; not included).
<b>V6046KD</b> <b>G6046KD</b> 	<b>Circuit Breaker Housing</b> – KOs in cover can be removed for installation of three single-pole breakers. For use with the following breakers rated 100A maximum.

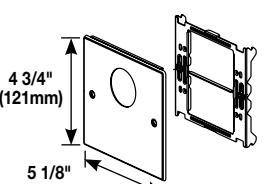
MANUFACTURER	SERIES
General Electric	THQC, THHQC
Westinghouse	Quicklag, C, QCH

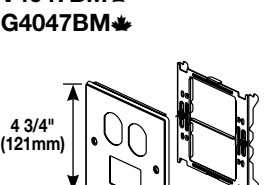
Catalog No./Item	Description/Specifications
<b>V6074</b> <b>G6074</b> 	<b>Take-Off Connector (6000 to 6000)</b> – For 90° tee connection at any point along a run of 6000.
<b>V6074A</b> <b>G6074A</b> 	<b>Take-Off Connector (6000 to 4000)</b> – For 90° tee connection at any point along a run of 6000.
<b>V6086</b> <b>G6086</b> 	<b>Panel Connector</b> – For connecting 6000 with surface type panel boxes. Accommodates maximum wire capacity of 6000 system. Separate C-flange fits around raceway, covering uneven cuts to the box. Cut 4 3/4" x 3 9/16" (121mm x 90mm) hole in panel box.
<b>V6007C-1</b> <b>G6007C-1</b> 	<b>Single-Gang Device Cover</b> – For vertical mounting single-gang devices on undivided raceway. Accepts commercially available wall plate (sold separately).
<b>V6007C-2</b> <b>G6007C-2</b> 	<b>Two-Gang Device Plate</b> – For installing two-gang devices or two vertically mounted single-gang devices on undivided raceway. Accepts commercially available wall plate (sold separately).

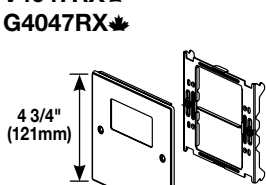
\* 4000C and 6000C are compatible with 4000B and 6000B Raceway.  
 † G6001DA Divider Clips are required to hold divider in place.

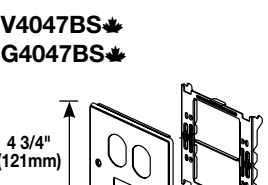
## 4047 Series Cover Plates Ordering Information

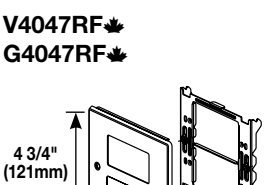
Catalog No./Item	Description/Specifications	Catalog No./Item	Description/Specifications
<b>V4047AX</b>  <b>G4047AX</b>  	<b>Two-Gang Overlapping Cover Single Round Opening</b> – For straight blade and locking single receptacles with face diameters of 1.38" to 1.39" (35mm to 36mm).	<b>V4047BT</b>  <b>G4047BT</b>  	<b>Two-Gang Overlapping Cover Duplex &amp; TracJack Mini Adapter</b> – For 15A and 20A duplex receptacles. Includes Mini adapter. Accepts two Ortronics® TracJack Communication Inserts.
<b>V4047BX</b>  <b>G4047BX</b>  	<b>Two-Gang Overlapping Cover Duplex Receptacle</b> – For 15A and 20A duplex receptacles. Accepts 106 Communications Duplex Frame.	<b>V4047C-1</b>  <b>G4047C-1</b>  	<b>One-Gang Overlapping Device Plate</b> – Use with commercially available single-gang flush plate (sold separately).
<b>V4047BB</b>  <b>G4047BB</b>  	<b>Two-Gang Overlapping Cover Two Duplex Receptacles</b> – For 15A and 20A duplex receptacles. Accepts 106 Communications Duplex Frame.	<b>V4047C-2</b>  <b>G4047C-2</b>  	<b>Two-Gang Overlapping Device Plate</b> – Use with commercially available two-gang flush plate (sold separately).
<b>V4047BF</b>  <b>G4047BF</b>  	<b>Two-Gang Overlapping Cover Duplex &amp; Modular Furniture</b> – For 15A and 20A duplex receptacles. Includes combination Modular Furniture and two Keystone twistouts. Accepts modular furniture adapter.	<b>V4047JX</b>  <b>G4047JX</b>  	<b>Two-Gang Overlapping Cover Single Round Opening</b> – For straight blade and single locking receptacles with face diameters of 1.56" – 1.58" (39mm – 40mm).
<b>V4047BM</b>  <b>G4047BM</b>  	<b>Two-Gang Overlapping Cover Duplex &amp; 2A Mini adapter</b> – For 15A and 20A duplex receptacles. Includes Mini adapter. Accepts Pass & Seymour® Activate inserts & Wiremold CM2 Series Open System Communication Modules.	<b>V4047RX</b>  <b>G4047RX</b>  	<b>Two-Gang Overlapping Cover Rectangle Opening</b> – For rectangular GFCI, Surge and decorator style devices. Does not accept 5507 Series Faceplates.
<b>V4047BS</b>  <b>G4047BS</b>  	<b>Two-Gang Overlapping Cover Duplex &amp; Series II Mini Adapter</b> – For 15A and 20A duplex receptacles. Includes Mini adapter. Accepts one Ortronics® Series II Communication Insert.	<b>V4047RF</b>  <b>G4047RF</b>  	<b>Two-Gang Overlapping Cover Rectangle Opening &amp; Modular Furniture</b> – For rectangular GFCI, Surge and decorator style devices. Does not accept 5507 Series Faceplates. Accepts modular furniture adapter and keystone RJ45 jacks.

**NOTE:** Faceplates can also be used with 6000 Series Raceway.

 Add "C" prefix to denote Canadian version – UL Listed to U.S. and Canadian Safety Standards. ©

## 4047 Series Cover Plates Ordering Information (continued)

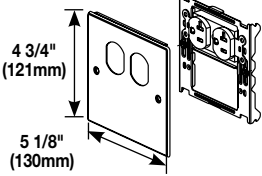
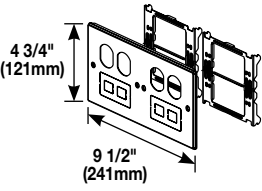
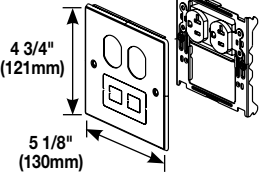
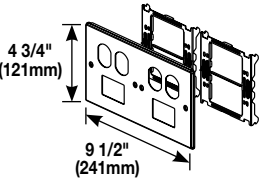
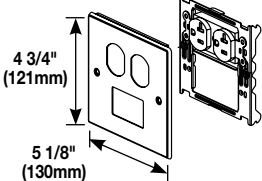
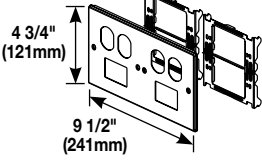
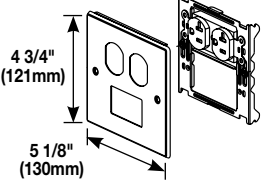
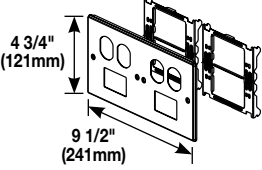
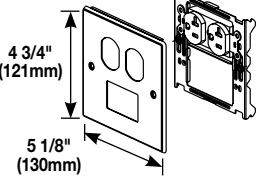
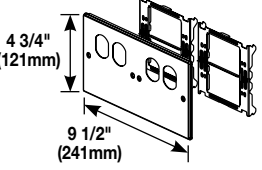
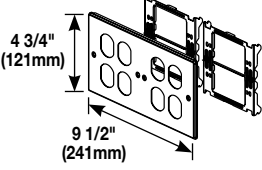
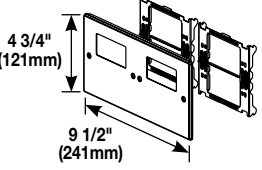
Catalog No./Item	Description/Specifications	Catalog No./Item	Description/Specifications
<b>V4047WX</b> ✦ <b>G4047WX</b> ✦ 	<b>Two-Gang Overlapping Cover with One Duplex Receptacle Installed</b> – Includes one Pass & Seymour Duplex Receptacle with 12" wire leads installed on bracket.	<b>V4047-2BBFF</b> ✦ <b>G4047-2BBFF</b> ✦ 	<b>Four-Gang Overlapping Cover Two Duplex &amp; Two Modular Furniture Openings</b> – For 15A and 20A duplex receptacles. Includes combination Modular Furniture & four Keystone Twistouts. Accepts keystone RJ45 or modular furniture adapter.
<b>V4047WF</b> ✦ <b>G4047WF</b> ✦ 	<b>Two-Gang Overlapping Cover with One Duplex Installed &amp; Modular Furniture Opening</b> – Includes one Pass & Seymour® 20 A Duplex Receptacle with 12" wire leads installed on bracket. Includes combination Modular Furniture and 2 Keystone Twist Out. Accepts modular furniture adapter and keystone RJ45 jacks.	<b>V4047-2BBMM</b> ✦ <b>G4047-2BBMM</b> ✦ 	<b>Four-Gang Overlapping Cover Two Duplex &amp; Two Activate Mini Adapters</b> – For 15A and 20A duplex receptacles. Includes Mini adapter. Accepts Activate inserts & Wiremold CM2 Series Open System Communications Modules.
<b>V4047WM</b> ✦ <b>G4047WM</b> ✦ 	<b>Two-Gang Overlapping Cover with One Duplex Installed &amp; Activate Mini adapter</b> – Includes one Pass & Seymour® 20A Duplex Receptacle with 12" wire leads installed on Bracket. Includes Mini adapter. Accepts Activate inserts & Wiremold CM2 Series Open System Communication Modules.	<b>V4047-2BBSS</b> ✦ <b>G4047-2BBSS</b> ✦ 	<b>Four-Gang Overlapping Cover Two Duplex &amp; Two Series II Mini Adapters</b> – For 15A and 20A duplex receptacles. Includes Mini adapter. Accepts two Ortronics® Series II Communication inserts.
<b>V4047WS</b> ✦ <b>G4047WS</b> ✦ 	<b>Two-Gang Overlapping Cover with One Duplex Installed &amp; Series II Mini adapter</b> – Includes one Pass & Seymour® 20A Duplex Receptacle with 12" wire leads installed on Bracket. Includes Mini adapter. Accepts one Ortronics® Series II Communications insert.	<b>V4047-2BBTT</b> ✦ <b>G4047-2BBTT</b> ✦ 	<b>Four-Gang Overlapping Cover Two Duplex &amp; Two TracJack Mini Adapters</b> – For 15A and 20A duplex receptacles. Includes Mini adapter. Accepts four Ortronics® TracJack Communications inserts.
<b>V4047WT</b> ✦ <b>G4047WT</b> ✦ 	<b>Two-Gang Overlapping Cover with One Duplex Installed &amp; TracJack Mini adapter</b> – Includes one Pass & Seymour® 20A Duplex Receptacle with 12" wire leads installed on Bracket. Includes Mini adapter. Accepts two Ortronics® TracJack Communications inserts.	<b>V4047-2BBXX</b> ✦ <b>G4047-2BBXX</b> ✦ 	<b>Four-Gang Overlapping Cover with Two Duplex Openings</b> – For 15A and 20A duplex receptacles. Accepts 106 Communication Duplex Frame.
<b>V4047-2BBBB</b> ✦ <b>G4047-2BBBB</b> ✦ 	<b>Four-Gang Overlapping Cover Four Duplex Openings</b> – For 15A and 20A duplex receptacles. Accepts 106 Communication Duplex Frame.	<b>V4047-2RRXX</b> ✦ <b>G4047-2RRXX</b> ✦ 	<b>Four-Gang Overlapping Cover Two Rectangular Openings</b> – For rectangular, GFCI, Surge and decorator style devices. Does not accept 5507 Series Faceplates.

**NOTE:** Faceplates can also be used with 6000 Series Raceway.  
 ✦ Add "C" prefix to denote Canadian version – UL Listed to U.S. and Canadian Safety Standards. (UL)

## 4047 Series Cover Plates Ordering Information (continued)

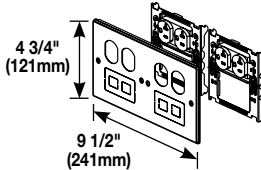
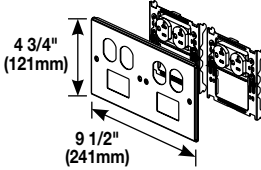
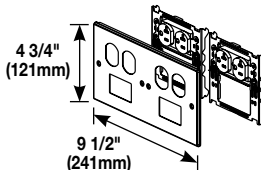
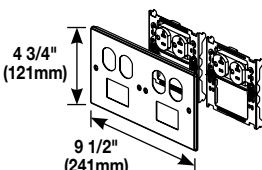
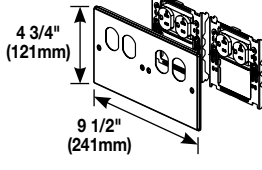
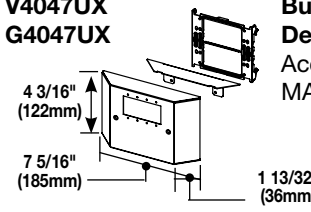
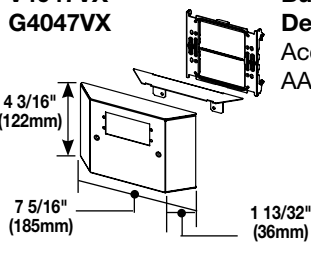
Catalog No./Item	Description/Specifications
<p><b>V4047-2WWFF</b> ✦ <b>G4047-2WWFF</b> ✦</p> 	<p><b>Four-Gang Overlapping Cover Two Duplex Installed &amp; Two Modular Furniture Openings</b> – Includes two, Pass &amp; Seymour® 20A Duplex Receptacles with 12" wire leads installed on Bracket. Includes combination Modular Furniture &amp; four keystone Twistouts. Accepts modular furniture adapter or RJ45.</p>
<p><b>V4047-2WWM</b> ✦ <b>G4047-2WWM</b> ✦</p> 	<p><b>Four-Gang Overlapping Cover with Two Duplex Installed &amp; Two Activate Mini Adapters</b> – Includes two Pass &amp; Seymour® 20A Duplex Receptacle with 12" wire leads installed on Bracket. Includes Mini adapter. Accepts two Activate inserts &amp; Wiremold CM2 Series Open System Communication Modules.</p>
<p><b>V4047-2WWS</b> ✦ <b>G4047-2WWS</b> ✦</p> 	<p><b>Four-Gang Overlapping Cover with Two Duplex Installed &amp; Two Series II Mini Adapters</b> – Includes two Pass &amp; Seymour® 20A Duplex Receptacles with 12" wire leads installed on Bracket. Includes Mini adapter. Accepts two Ortronics® Series II Communication inserts.</p>
<p><b>NOTE:</b> Faceplates can also be used with 6000 Series Raceway.                  ✦ Add "C" prefix to denote Canadian version – UL Listed to U.S. and Canadian Safety Standards. (UL)</p>	
<p><b>V4047-2WWTT</b> ✦ <b>G4047-2WWTT</b> ✦</p> 	<p><b>Four-Gang Overlapping Cover with Two Duplex Installed &amp; Two TracJack Mini Adapters</b> – Includes two Pass &amp; Seymour® 20A Duplex Receptacles with 12" wire leads installed on Bracket. Includes Mini adapter. Accepts four Ortronics® TracJack Communications inserts.</p>
<p><b>V4047-2WWXX</b> ✦ <b>G4047-2WWXX</b> ✦</p> 	<p><b>Four-Gang Overlapping Cover with Two Duplex Receptacles Installed</b> – Includes two Pass &amp; Seymour® 20A Duplex Receptacles with 12" wire leads installed on Bracket.</p>
<p><b>V4047UX</b> <b>G4047UX</b></p> 	<p><b>Bump-Up Extron® MAAP Device Plate</b> – Accepts four Extron® Electronics MAAP single space modules.</p>
<p><b>V4047VX</b> <b>G4047VX</b></p> 	<p><b>Bump-Up Extron® AAP Device Plate</b> – Accepts two Extron® Electronics AAP single space modules.</p>

## 4047 Series Configurable Cover Plates Number Logic

1. For "X", Choose one of the following options:

**V** Ivory & UL Listed  
**G** Gray & UL Listed

**CV** Ivory & cULus Listed (Canada only)  
**CG** Gray & cULus Listed (Canada only)

2. Choose a Plate Configuration:

**Two-Gang Plate:**

**X** 4047  $\frac{Y}{1}$   $\frac{Y}{2}$

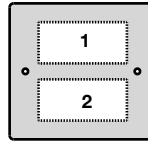





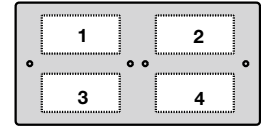







**Four-Gang Plate:**

**X** 4047-2  $\frac{Y}{1}$   $\frac{Y}{2}$   $\frac{Y}{3}$   $\frac{Y}{4}$



3. For "Y", Choose any combination of configurations from the options listed below:

- |  |   |   |
|--|---|---|
| <p><b>A.</b>  1.41" (35.8mm) Diameter, Single Round Receptacle</p> <p><b>B.</b>  Duplex Receptacle Opening</p> <p><b>F.</b>  Combination Modular Furniture &amp; 2 Keystone Twist Out</p> <p><b>H.</b>  Mouse Hole Twist Out &amp; Grommet</p> | <p><b>J.</b>  1.59" (40mm) Diameter, Single Round Receptacle</p> <p><b>M.</b>  Pass &amp; Seymour Activate 2A Mini adapter Opening with Adapter</p> <p><b>R.</b>  Rectangular Receptacle</p> <p><b>S.</b>  Ortronics Series II 2A Mini adapter Opening with Adapter</p> | <p><b>T.</b>  Ortronics TracJack 2A Mini Adapter Adapter Opening with Adapter</p> <p><b>W.</b>  Pass &amp; Seymour Light Almond 20 Amp Receptacle pre-pigtailed with 12" wire leads installed on Bracket</p> <p><b>X.</b>  Blank</p> <p><b>Z.</b>  3 Keystone Twist Out</p> |
|--|---|---|

4. Finished Part Number

\_ 4047 \_ \_ \_ \_ 4047-2 \_ \_ \_ \_

**NOTE:** For additional colors or configurations, call 1-800-621-0049, option 2.

## 4000 Series Faceplates Ordering Information

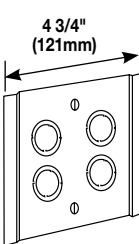
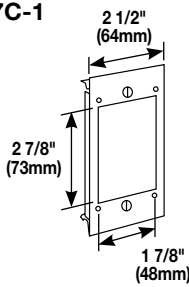
Catalog No./Item	Description/Specifications
<b>V4046H-2</b> <b>G4046H-2</b>	<b>Tap-Off Fitting</b> – Has four concentric 1/2" and 3/4" trade size KO's.
	
<b>V6007C-1</b> <b>G6007C-1</b>	<b>Single-Gang Device Cover</b> – For vertical mounting single-gang devices on undivided raceway. Accepts commercially available wall plate (sold separately).
	

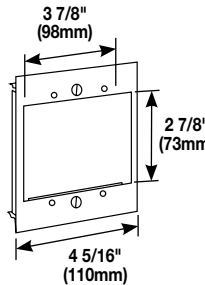
Catalog No./Item	Description/Specifications
<b>V6007C-2</b> <b>G6007C-2</b>	<b>Two-Gang Device Plate</b> – For installing two-gang devices or two vertically mounted single-gang devices on undivided raceway. • Accepts commercially available wall plate (not furnished).
	

**NOTE:** Faceplates can also be used with 6000 Series Raceway.  
➤ Add "C" prefix to denote Canadian version – UL Listed to U.S. and Canadian Safety Standards. (UL)

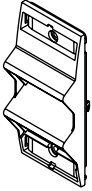
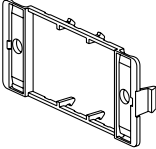
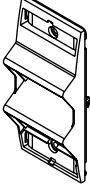
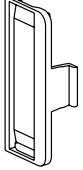

## Communication Endplates Ordering Information

Catalog No./Item	Description/Specifications	Catalog No./Item	Description/Specifications
<b>ARA-S2*</b> 	<b>Angled Raceway Adapter</b> – For use with 4050 device brackets and WallSource device mounting brackets. Angled exit provides additional mounting depth required for A/V connections as well as ensuring the required bend radius for UTP and fiber optic cabling. Holds two Ortronics® Series II modules. Fits 5507 Series Faceplate opening.	<b>CM-EPLA*</b> 	<b>End Plates</b> – Includes two outlet identification labels with clear covers and two matching screw covers. Required for mounting Pass & Seymour® Activate and Wiremold CM2 Series Open System communication modules into 4050 Series device brackets.
<b>CM-ARA*</b> 	<b>Angled Raceway Adapter</b> – For use with 4050 device brackets and WallSource device mounting brackets. Angled exit provides additional mounting depth required for A/V connections as well as ensuring the required bend radius for UTP and fiber optic cabling. Holds two Wiremold CM2 Series Open System modules or two Pass & Seymour® 2A inserts. Fits 5507 Series Faceplate opening.	<b>S2-EPL*</b> 	<b>End Plates</b> – Includes two outlet identification labels with clear covers and two matching screw covers. Required for mounting Ortronics Series II modules into 4050 Series device brackets.

\* Add "G" suffix to indicate gray finish.

## V/G4050 & 5507 Series Faceplates Ordering Information

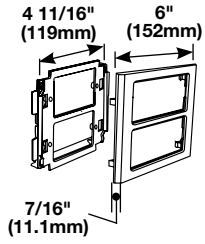
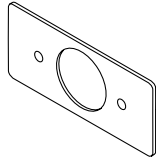
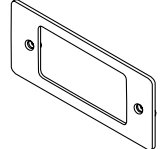
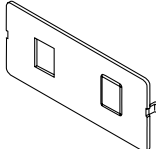
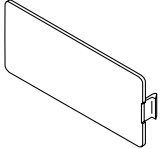
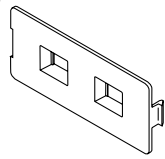
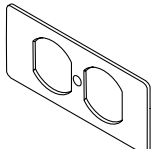
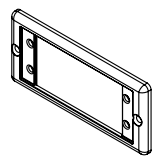
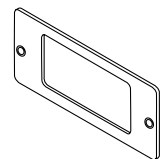
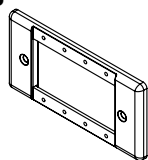
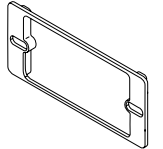
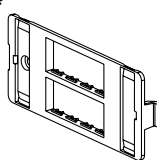
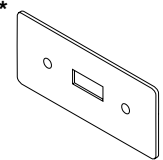
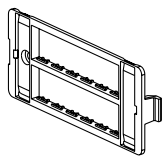
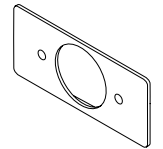
Catalog No./Item	Description/Specifications	Catalog No./Item	Description/Specifications
<b>V4050*</b> <b>G4050*</b> 	<b>Device Mounting Bracket</b> – High impact plastic mounting bracket and trim plate which overlap raceway cover providing a seamless transition. For use with 5507 Series Faceplates, Ortronics® TracJack & Series II Modules, Pass & Seymour Activate Series Inserts, and Wiremold CM2 Series Open System Communication Modules.	<b>5507T2*</b> 	<b>Single Receptacle Faceplate</b> – For covering single receptacles – 1.41" (35.8mm) diameter.
<b>5507AD*</b> 	<b>Modular Furniture Adapter</b> – For mounting modular furniture adapters.	<b>5507RJ*</b> 	<b>Dual RJ11/RJ45 Connector Faceplate</b> – For mounting one or two RJ type keystone connectors – has one opening and a KO for the other.
<b>5507B*</b> 	<b>Blank Faceplate</b> – For covering unused compartments in the device bracket.	<b>5507FRJ*</b> 	<b>Flush Dual RJ11/RJ45 Faceplate</b> – Same as 5507RJ except the connectors are recessed to provide a flush installation.
<b>5507D*</b> 	<b>Duplex Faceplate</b> – For covering duplex style devices. Accepts 106 Communication Duplex Frame.	<b>5507AAP</b> 	<b>Extron® AAP Faceplate</b> – Accepts two Extron® Electronics AAP single space modules.
<b>5507R*</b> 	<b>Rectangular Faceplate</b> – For covering rectangular style devices.	<b>5507MAAP</b> 	<b>Extron® MAAP Faceplate</b> – Accepts four Extron® Electronics MAAP single space modules.
<b>5507S*</b> 	<b>Rectangular Spacer</b> – For mounting commercial device plates. Installs between the device bracket and a device.	<b>5507-4TJ*</b> 	<b>Ortronics Faceplate</b> – For mounting Ortronics® communication inserts. Accepts four TracJack Devices.
<b>5507SW*</b> 	<b>Switch Faceplate</b> – For covering standard toggle switches.	<b>5507-6TJ*</b> 	<b>Ortronics Faceplate</b> – For mounting Ortronics® communication inserts. Accepts six TracJack Devices.
<b>5507T1*</b> 	<b>Single Receptacle Faceplate</b> – For covering single receptacles – 1.59" (40.4mm) diameter.		

**NOTE:** All faceplates are 4 1/4" long x 1 11/16" wide (108mm x 43mm).

\* Add "G" suffix to indicate gray finish.

Not for use with 4047BF and 4047RF Device Covers.



# NOTES

**NOTE: All brand and product names referenced in this document are registered trademarks or trademarks of their respective holders.**



**NOTE:** The paper used to print this document is an environmentally responsible paper with 10% post consumer waste, with FSC and SFI Chain of Custody certifications, Lacey Act compliant. 100% of the electricity used to manufacture Flo sheets is generated with Green-e certified renewable energy.



#### Electrical Wiring Systems

60 Woodlawn Street  
West Hartford, CT 06110  
Phone: 1.877.BY.LEGRAND (295-3472)  
[www.legrand.us](http://www.legrand.us)

570 Applewood Crescent  
Vaughan, Ontario L4K 4B4  
Phone: 905.738.9195  
[www.legrand.ca](http://www.legrand.ca)

