

## Steel Pancake® Overfloor Raceway

Pancake® Overfloor Steel Raceway is ideal for open space wiring of workstations and desk areas in high traffic sites. Both the 1500 and 2600 Series Raceways mount directly to the floor and provide safe load bearing strength for normal office use.

Both raceway models offer a full complement of fittings and device boxes for power and communication wiring. Pancake Overfloor Raceway comes unpainted with a paintable galvanized finish.

Both 1500 and 2600 Series Overfloor Raceway provide solutions for bringing power or communication services to open space designs.

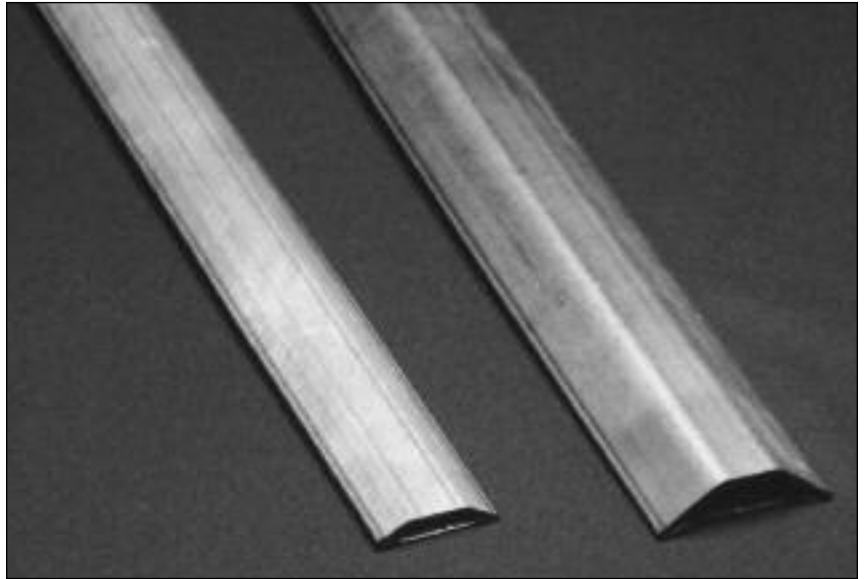

### FEATURES & BENEFITS

- **Installs in open space areas.** Brings power or telephone and signal wiring to away-from-wall locations.
- **Flat profile.** Unobtrusive, low-profile appearance.
- **Galvanized steel.** Assures durability.
- **2600 Series withstands approximately 150 lbs./sq in.** Provides safe load bearing strength for normal office traffic.
- **1500 Series withstands approximately 200 lbs./sq in.** Provides safe load strength for normal office traffic.
- **Full line of fittings.** Provides a complete and safe installation.
- **Unpainted.** Paintable to match decor.
- **UL Listed and CSA certified.** File E4376 Guide RJBT fittings. File 41751 Guide RJPR. CSA File 350.
- **UL5.** Raceway is compliant with UL5 specifications.

1500 and 2600 Series Overfloor Raceway can be installed over floor coverings to provide either permanent or temporary access to services.



## 1500 Series Overfloor Raceway System Layout

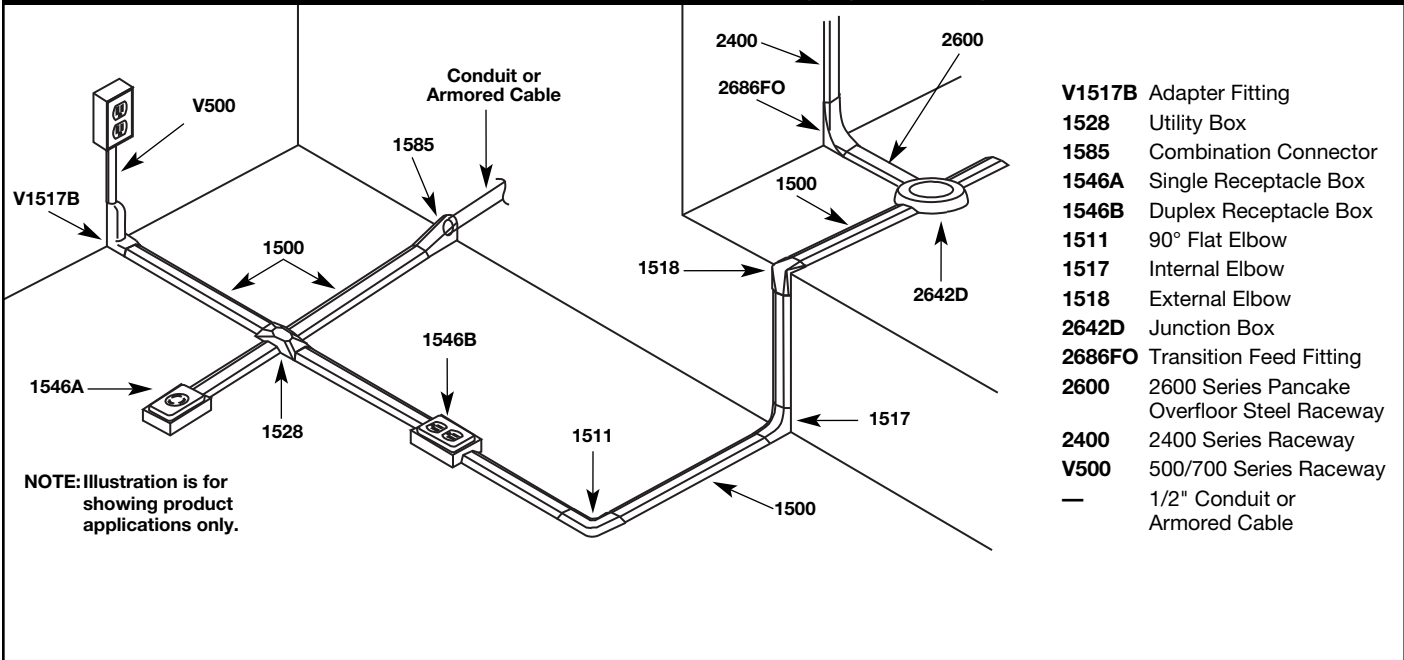

- V1517B** Adapter Fitting
- 1528** Utility Box
- 1585** Combination Connector
- 1546A** Single Receptacle Box
- 1546B** Duplex Receptacle Box
- 1511** 90° Flat Elbow
- 1517** Internal Elbow
- 1518** External Elbow
- 2642D** Junction Box
- 2686FO** Transition Feed Fitting
- 2600** 2600 Series Pancake Overfloor Steel Raceway
- 2400** 2400 Series Raceway
- V500** 500/700 Series Raceway
- 1/2" Conduit or Armored Cable

## 1500 Series Overfloor Raceway System Wire Fill Capacity Charts

### 1500 Series Overfloor Raceway Wire Fill Capacities for Power



	WIRE SIZE THHN/THWN	O.D.		40% FILL
		inches	[mm]	
POWER WIRING	14 AWG	0.111	[2.8]	9
	12 AWG	0.130	[3.3]	6
	10 AWG	0.164	[4.2]	4

### 1500 Series Overfloor Raceway Wire Fill Capacities for Communications

	CABLE/WIRE SIZE	O.D. (Approx. Dia.)		40% FILL
		Inches	[mm]	
UNSHIELDED TWISTED PAIR	4-pair, 24 AWG, Cat 3	0.190	[4.8]	3
	4-pair, 24 AWG, Cat 5e	0.210	[5.3]	2
	4-pair, 24 AWG, Cat 6	0.250	[6.3]	1
	4-pair, 24 AWG, Cat 6a*	0.354	[9.0]	0
	25-pair, 24 AWG	0.410	[10.4]	0
COAXIAL	RG6/U	0.270	[6.9]	1
FIBER	ZipCord	0.118 x 0.236	[3 x 6]	3
	Round 4 Strand Fiber	0.187	[4.8]	3
	Round 6 Strand Fiber	0.256	[6.5]	1

**NOTE:** For additional information, refer to the Technical Section.  
 \* Category 6 augmented (6a) cable for 10 gigabit ethernet – max allowed cable diameter per addenda No. 11 ANSI TIA/EIA 568-B.2.

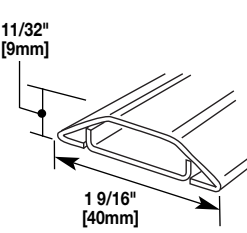
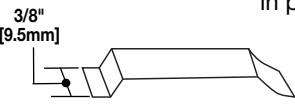
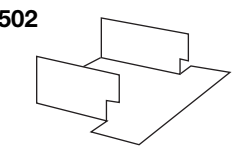
## 1500 Series Overfloor Raceway System Ordering Information

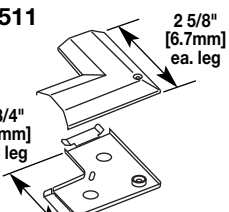
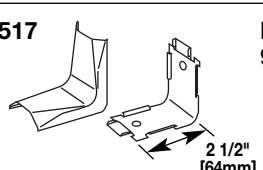
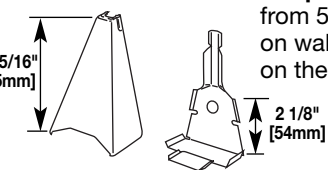
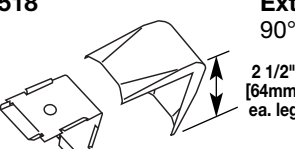
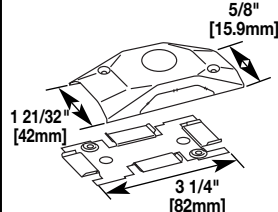
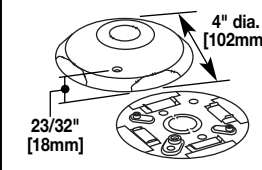
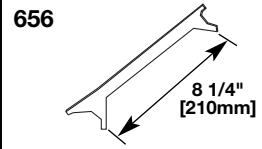
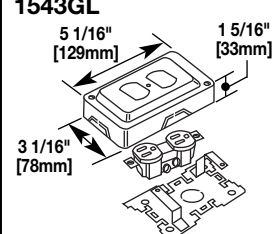
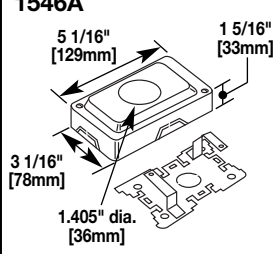
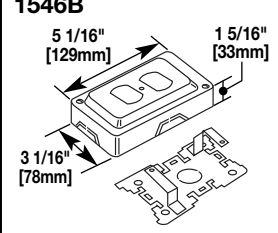
Catalog No./Item	Description/Specifications
<p><b>1500-10</b></p> 	<p><b>Base and Cover</b> – .040" [1mm] galvanized steel. Packed ten (10) 10' [3.05m] lengths per carton. Base has 9/32" [7.1mm] mounting holes on 8" [203mm] centers.</p>
<p><b>1500WC</b></p> 	<p><b>Wire Clip</b> – For holding conductors in place. Not UL Listed.</p>
<p><b>1502</b></p> 	<p><b>Fiber Bushing</b> – Protects wires from abrasion. Slips into open end of 1500 Series Raceway where it enters a fitting.</p>
<p><b>1504</b></p> 	<p><b>Strap</b> – Two-hole strap. Use to fasten 1500 Series Raceway to surfaces at any point desired.</p>
<p><b>1511</b></p> 	<p><b>90° Flat Elbow</b> – For right angle turns on the same surface.</p>
<p><b>1517</b></p> 	<p><b>Internal Elbow</b> – For internal 90° corners.</p>
<p><b>V1517B</b></p> 	<p><b>Adapter Fitting</b> – To feed to or from 500 or 700 Series Raceway on wall to 1500 Series Raceway on the floor.</p>
<p><b>1518</b></p> 	<p><b>External Elbow</b> – For external 90° corners.</p>
<p><b>1528</b></p> 	<p><b>Utility Box</b> – Cover has 1/2" trade size KO. May be used as a cross, tee, straight through, or to terminate run. Two 1500WC wire clips included. No knockouts on base of unit.</p>
<p><b>1542D</b></p> 	<p><b>Junction Box</b> – May be used as a cross, tee, or elbow. Base has 1/2" and 3/4" trade size concentric KOs. Cover has 1/2" trade size KO. Two 1500WC wire clips included.</p>
<p><b>656</b></p> 	<p><b>Cover Removal Tool</b> – For removing cover of 1500 and 2600 Series Overfloor Raceways.</p>
<p><b>1543GL</b></p> 	<p><b>Grounding Duplex</b> – Cover has 1500 and 2600 twistouts on all four sides. Base has 1/2" and 3/4" concentric trade size KOs. Two 1500WC Wire Clips included. Gray finish.</p>
<p><b>1546A</b></p> 	<p><b>Single Receptacle Box</b> – Accommodates commercially available straight blade and locking single receptacles with face diameters of 1.38-1.40" [34.5-35mm]. Base has concentric 1/2" and 3/4" trade size KOs. Cover has 1500 and 2600 twistouts on all four sides. Two 1500WC wire clips included.</p>
<p><b>1546B</b></p> 	<p><b>Duplex Receptacle Box</b> – Accommodates commercially available 15A or 20A duplex receptacles. Base has concentric 1/2" and 3/4" trade size KOs. Cover has 1500 and 2600 twistouts on all four sides. Two 1500WC wire clips included. Side wiring recommended.</p>

**1500 Series Overfloor Raceway System Ordering Information** (continued)

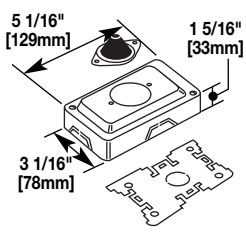
Catalog No./Item	Description/Specifications
<p><b>1546T</b></p> 	<p><b>Telephone Outlet Box</b> – Furnished with 1/2" [12.7mm] rubber stem. Accepts modular connecting blocks within the fitting. Cover has 1500 and 2600 twistouts on both ends and both sides. Two 1500WC wire clips included. Not UL Listed.</p>

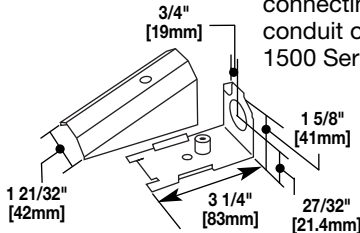
Catalog No./Item	Description/Specifications
<p><b>1585</b></p> 	<p><b>Combination Connector</b> – For connecting 1/2" trade size conduit or armored cable to 1500 Series Raceway.</p>

## 2600 Series Overfloor Raceway System Layout

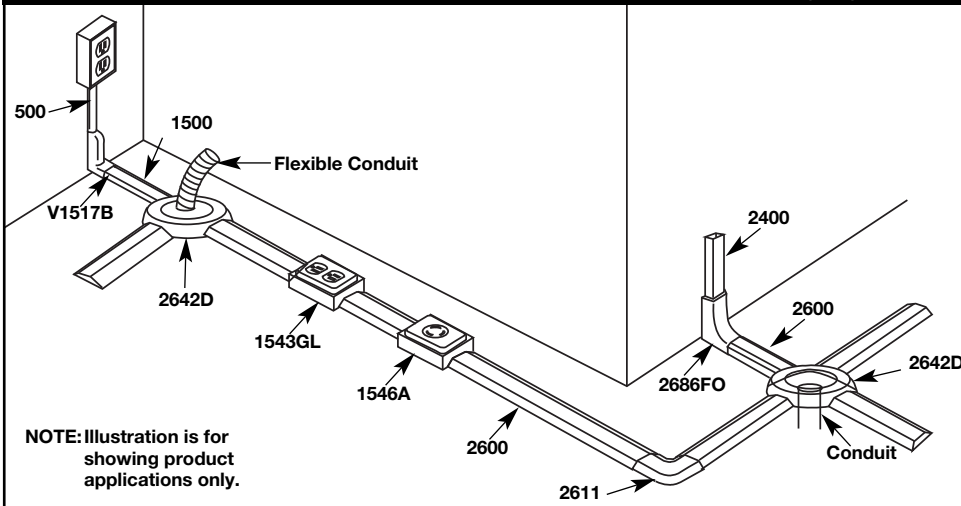

- 2642D** Junction Box
- 1543GL** Grounding Duplex Receptacle & Cover
- 1546A** Single Receptacle Box
- 2611** 90° Flat Elbow
- 2686FO** Transition Feed Fitting
- 2400** Wiremold 2400 Series Raceway
- 1500** Wiremold 1500 Series Raceway
- V1517B** Adapter Fitting
- 2600** Wiremold 2600 Series Overfloor Steel Raceway
- 500** Wiremold 200, 500 or 700 Series Raceway
- Conduit** 1/2" [12.7mm] Flexible Conduit
- Conduit** 1/2" or 3/4" Conduit to Underfloor Duct System

## 2600 Series Overfloor Raceway System Wire Fill Capacity Charts

### 2600 Series Overfloor Raceway Wire Fill Capacities for Power

	WIRE SIZE THHN/THWN	O.D.		NO. OF CONDUCTORS 40% FILL
		inches	[mm]	
POWER WIRING	14 AWG	0.111	[2.8]	29
	12 AWG	0.130	[3.3]	21
	10 AWG	0.164	[4.2]	13

### 2600 Series Overfloor Raceway Wire Fill Capacities for Communications

	CABLE/WIRE SIZE	O.D. (Approx. Dia.)		40% FILL
		Inches	[mm]	
UNSHIELDED TWISTED PAIR	4-pair, 24 AWG, Cat 3	0.190	[4.8]	10
	4-pair, 24 AWG, Cat 5e	0.210	[5.3]	8
	4-pair, 24 AWG, Cat 6	0.250	[6.3]	5
	4-pair, 24 AWG, Cat 6a*	0.354	[9.0]	2
	25-pair, 24 AWG	0.410	[10.4]	2
COAXIAL	RG6/U	0.270	[6.9]	5
FIBER	ZipCord	0.118 x 0.236	[3 x 6]	10
	Round 4 Strand Fiber	0.187	[4.8]	10
	Round 6 Strand Fiber	0.256	[6.5]	5

NOTE: For additional information, refer to the Technical Section.

\* Category 6 augmented (6a) cable for 10 gigabit ethernet – max allowed cable diameter per addenda No. 11 ANSI TIA/EIA 568-B.2.

## 2600 Series Overfloor Raceway System Ordering Information

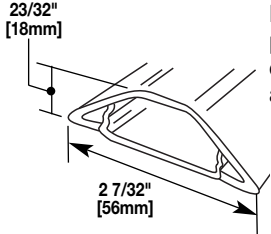
Catalog No./Item	Description/Specifications
<b>2600-10</b>  	<b>Base and Cover</b> – Cover: .050" [1.25mm] galvanized steel. Base: .040" [1mm] galvanized steel. Packed (5) 10 ft. [3.050m] lengths per carton. Base has 9/32" [7.1mm] dia. mounting holes on centers of approximately 8" [203mm].

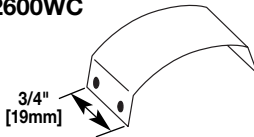
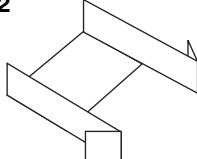
Catalog No./Item	Description/Specifications
<b>2600WC</b>  	<b>Wire Clip</b> – For holding conductors in place.
<b>2602</b>  	<b>Fiber Bushing</b> – Protects wires from abrasion. Bushing slips into open end of 2600 where it enters a fitting.

## 1500 Series Overfloor Raceway System Ordering Information (continued)

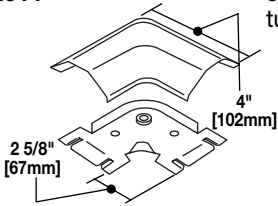
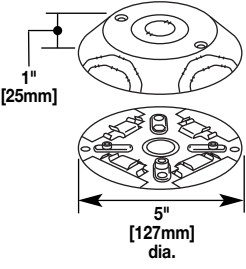
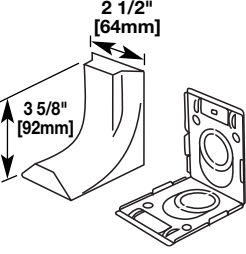
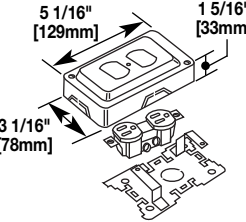
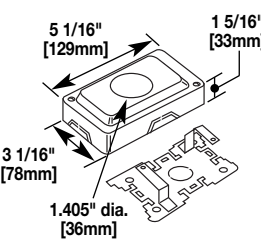
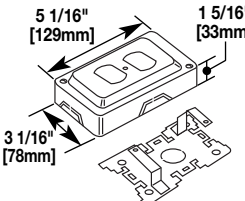
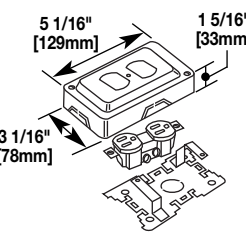
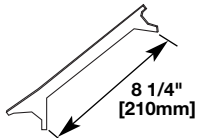
Catalog No./Item	Description/Specifications	Catalog No./Item	Description/Specifications
2611	<p><b>90° Flat Elbow</b> – For right angle turns on same surface.</p> 	1546A	<p><b>Single Receptacle Box</b> – Accommodates commercially available straight blade and locking single receptacles with face diameters of 1.38-1.40" [34.5-35mm]. Base has concentric 1/2" and 3/4" trade size KOs. Cover has 1500 and 2600 twistouts on all four sides. Two 1500WC wire clips included.</p> 
2642D	<p><b>Junction Box</b> – May be used with 1500 and/or 2600 as a cross, tee, or elbow. Cover has 1/2" trade size KO. Base has concentric 1/2" and 3/4" trade size KO to enable connection to floor, outlet boxes, or under floor duct systems (use chase nipple – not included). Two 2600WC wire clips included.</p> 	1546B	<p><b>Duplex Receptacle Box</b> – Accommodates commercially available 15A or 20A duplex receptacles. Base has concentric 1/2" and 3/4" trade size KOs. Cover has 1500 and 2600 twistouts on all four sides. Two 1500WC wire clips included. Side wiring recommended.</p> 
2686FO	<p><b>Transition Feed Fitting</b> – To feed 2600 Series Raceway on the floor from 2400 Series raceway on wall. Has concentric 3/4" and 1" trade size KOs with 1" trade size KO elongated so adjustment from surface to center of bushing is 1" to 1 5/8" [25mm to 41mm] maximum. Has twistouts for transition to 1500 and 2600 Series Raceway.</p> 	1546T	<p><b>Telephone Outlet Box</b> – Furnished with 1/2" [12.7mm] rubber stem. Accepts modular connecting blocks within the fitting. Cover has 1500 and 2600 twistouts on both ends and both sides. Two 1500WC wire clips included. Not UL Listed.</p> 
1543GL	<p><b>Grounding Duplex</b> – Cover has 1500 and 2600 twistouts on all four sides. Base has concentric 1/2" and 3/4" KOs. Two 1500WC Wire Clips included.</p> 	656	<p><b>Cover Removal Tool</b> – For removing cover of 1500 and 2600 Series Overfloor Raceways.</p> 

# NOTES

# NOTES



## Electrical Wiring Systems

60 Woodlawn Street  
West Hartford, CT 06110  
Phone: 1.877.BY.LEGRAND (295-3472)  
[www.legrand.us](http://www.legrand.us)

570 Applewood Crescent  
Vaughan, Ontario L4K 4B4  
Phone: 905.738.9195  
[www.legrand.ca](http://www.legrand.ca)

