

# GR and GRF Conduit Outlet Boxes

## Explosionproof, Dust-Ignitionproof

UNILETS® for use with Threaded Metal Conduit. Furnished with Internal Ground Screw and O-Ring.

### NEC/CEC:

Class I, Division 1 and 2, Groups B♦, C, D

Class II, Division 1 and 2, Groups E, F, G

Class III

NEMA 3, 4, 4X ①

Class 1, Zone 1 and 2, IIA, IIB

### Applications

- Complies with a wide range of classified area requirements.
- Corrosion-resistant: ideal indoors or out.
- For pulling of wires.
- Connect conduit lengths and change direction of conduit runs.
- Provide access for maintenance.

### Features

- GR boxes offers ten hub arrangements.
- GRF boxes have integral mounting flange.
- Malleable iron bodies have high tensile strength, ductility and provides great resistance to corrosion, impact, and shock.
- Accurately tapped, tapered hub threads for tight, rigid joints and ground continuity.
- Furnished with covers.
- General purpose wiring.
- Function as sealing fittings when used with sealing covers (see NEC for restrictions).
- Internally threaded body with externally threaded cover.
- Covers have pry notches for bar or wrench.
- Accommodate sealing, dome, hub and union hub covers, and canopies.
- Standard O-rings provide raintight fit. NEMA 3, 4.
- Internal ground screw standard.
- Smooth, rounded integral bushing in each hub type box protects conductor insulation.



### Standard Materials

- Body: malleable iron or copperfree (4/10 of 1% max.) aluminum
- Cover: copperfree (4/10 of 1% max.) aluminum

### Standard Finishes

- Malleable iron bodies and covers: triple-coat — (1) zinc electroplate, (2) chromate, and (3) epoxy powder coat
- Aluminum bodies and covers: epoxy powder coat

### Options

- To order body without cover, add suffix **-LC** to catalog number.
- For malleable iron body and cover, add suffix **-M**.

### NEC/CEC Certifications and Compliances

- UL Listed: E85310, E10444
- CSA Standard: C22.2 No. 25, C22.2 No. 30
- CSA Certified: 025875

♦ In Class I, Division 1, Group B atmospheres, all conduit runs must have a sealing fitting (not supplied) field-installed adjacent to the enclosure.

① Aluminum body and cover only.

# GR Conduit Outlet Boxes

## Explosionproof, Dust-Ignitionproof

UNILETS® for use with Threaded Metal Conduit. Furnished with Internal Ground Screw and O-Ring.

**NEC/CEC:**







Class I, Division 1 and 2, Groups B♦, C, D

Class II, Division 1 and 2, Groups E, F, G

Class III

NEMA 3, 4, 4X ①

Class 1, Zone 1 and 2, IIA, IIB

Hub Type	Conduit Size (Inches)	Cover Opening mm (in)	Volume Capacity dm³ (in³)	Form Number ④	Catalog Number ②	
					Malleable Iron ③ Body With Aluminum Cover	Aluminum Body with Aluminum Cover
	1/2	85.9 (3.38)	0.29 (18.0)	1	GRE50	GRE50-A
	3/4	85.9 (3.38)	0.29 (18.0)	1	GRE75	GRE75-A
	1	85.9 (3.38)	0.29 (18.0)	1	GRE100	GRE100-A
	1-1/4	100.1 (3.94)	0.51 (31.0)	2	GRE125	GRE125-A
	1-1/2	124.0 (4.88)	1.18 (72.0)	3	GRE150	GRE150-A
	1/2	85.9 (3.38)	0.29 (18.0)	1	GRC50	GRC50-A
	3/4	85.9 (3.38)	0.29 (18.0)	1	GRC75	GRC75-A
	1	85.9 (3.38)	0.29 (18.0)	1	GRC100	GRC100-A
	1-1/4	100.1 (3.94)	0.51 (31.0)	2	GRC125	GRC125-A
	1-1/2	124.0 (4.88)	1.18 (72.0)	3	GRC150	GRC150-A
	2	124.0 (4.88)	1.25 (76.0)	3	GRC200	GRC200-A
	1/2	85.9 (3.38)	0.29 (18.0)	1	GRL50	GRL50-A
	3/4	85.9 (3.38)	0.29 (18.0)	1	GRL75	GRL75-A
	1	85.9 (3.38)	0.29 (18.0)	1	GRL100	GRL100-A
	1-1/4	100.1 (3.94)	0.51 (31.0)	2	GRL125	GRL125-A
	1-1/2	124.0 (4.88)	1.18 (72.0)	3	GRL150	GRL150-A
	2	124.0 (4.88)	1.25 (76.0)	3	GRL200	GRL200-A
	1/2	85.9 (3.38)	0.29 (18.0)	1	GRLB50	GRLB50-A
	3/4	85.9 (3.38)	0.29 (18.0)	1	GRLB75	GRLB75-A
	1	85.9 (3.38)	0.29 (18.0)	1	GRLB100	GRLB100-A
	1-1/4	100.1 (3.94)	0.51 (31.0)	2	GRLB125	GRLB125-A
	1-1/2	124.0 (4.88)	1.18 (72.0)	3	GRLB150	GRLB150-A
	2	124.0 (4.88)	1.25 (76.0)	3	GRLB200	GRLB200-A
	1/2	85.9 (3.38)	0.29 (18.0)	1	GRN50	GRN50-A
	3/4	85.9 (3.38)	0.29 (18.0)	1	GRN75	GRN75-A
	1	85.9 (3.38)	0.29 (18.0)	1	GRN100	GRN100-A
	1-1/4	100.1 (3.94)	0.51 (31.0)	2	GRN125	GRN125-A
	1-1/2	124.0 (4.88)	1.18 (72.0)	3	GRN150	GRN150-A
	1/2	85.9 (3.38)	0.29 (18.0)	1	GRT50	GRT50-A
	3/4	85.9 (3.38)	0.29 (18.0)	1	GRT75	GRT75-A
	1	85.9 (3.38)	0.29 (18.0)	1	GRT100	GRT100-A
	1-1/4	100.1 (3.94)	0.51 (31.0)	2	GRT125	GRT125-A
	1-1/2	124.0 (4.88)	1.18 (72.0)	3	GRT150	GRT150-A
	2	124.0 (4.88)	1.25 (76.0)	3	GRT200	GRT200-A
	1/2	85.9 (3.38)	0.29 (18.0)	1	GRX50	GRX50-A
	3/4	85.9 (3.38)	0.29 (18.0)	1	GRX75	GRX75-A
	1	85.9 (3.38)	0.29 (18.0)	1	GRX100	GRX100-A
	1-1/4	100.1 (3.94)	0.51 (31.0)	2	GRX125	GRX125-A
	1-1/2	124.0 (4.88)	1.18 (72.0)	3	GRX150	GRX150-A
	2	124.0 (4.88)	1.25 (76.0)	3	GRX200	GRX200-A

♦ In Class I, Division 1, Group B atmospheres, all conduit runs must have a sealing fitting (not supplied) field-installed adjacent to the enclosure.

① Aluminum body and cover only.

② Other covers available—see GR and GRF Conduit Outlet Box Covers page. Order separately.

③ For malleable iron body and cover, add suffix **-M**.

④ Form number designates body and matching cover sizes. To order body without cover, add suffix **-LC** to catalog number.

# GR Conduit Outlet Boxes

## Explosionproof, Dust-Ignitionproof

UNILETS® for use with Threaded Metal Conduit. Furnished with Internal Ground Screw and O-Ring.

**NEC/CEC:**



Class I, Division 1 and 2, Groups B♦, C, D

Class II, Division 1 and 2, Groups E, F, G

Class III

NEMA 3, 4, 4X ①

Class 1, Zone 1 and 2, IIA, IIB

Hub Type	Conduit Size (Inches)	Cover Opening mm (in)	Volume Capacity dm³ (in³)	Form Number ④	Catalog Number ②	
					Malleable Iron ③ Body With Aluminum Cover	Aluminum Body with Aluminum Cover
	1/2	85.9 (3.38)	0.29 (18.0)	1	<b>GRCA50</b>	<b>GRCA50-A</b>
	3/4	85.9 (3.38)	0.29 (18.0)	1	<b>GRCA75</b>	<b>GRCA75-A</b>
	1/2	85.9 (3.38)	0.29 (18.0)	1	<b>GRLA50</b>	<b>GRLA50-A</b>
	3/4	85.9 (3.38)	0.29 (18.0)	1	<b>GRLA75</b>	<b>GRLA75-A</b>
	1/2	85.9 (3.38)	0.29 (18.0)	1	<b>GRTA50</b>	<b>GRTA50-A</b>
	3/4	85.9 (3.38)	0.29 (18.0)	1	<b>GRTA75</b>	<b>GRTA75-A</b>

**Dimensions in Millimeters (Inches)**

Hub Size (Inches)	Dimensions in Millimeters (Inches)						
	A	B	C	D	E	F	G
<b>GR Series, Form 1</b>							
1/2	95.3 (3.75)	62 (2.44)	73.2 (2.88)	19.1 (0.75)	20.6 (0.81)	57.2 (2.25)	31.8 (1.25)
3/4	95.3 (3.75)	62 (2.44)	73.2 (2.88)	19.1 (0.75)	20.6 (0.81)	57.2 (2.25)	31.8 (1.25)
1	95.3 (3.75)	62 (2.44)	73.2 (2.88)	19.1 (0.75)	20.6 (0.81)	57.2 (2.25)	31.8 (1.25)
<b>GR Series, Forms 2 and 3</b>							
1-1/4	114.3 (4.50)	68.3 (2.69)	90.4 (3.56)	30.2 (1.19)	22.4 (0.88)	69.9 (2.75)	28.7 (1.13)
1-1/2	146.1 (5.75)	95.3 (3.75)	122.2 (4.81)	35.1 (1.38)	23.9 (0.94)	103.1 (4.06)	38.1 (1.50)
2	146.1 (5.75)	101.6 (4.00)	128.5 (5.06)	41.4 (1.63)	25.4 (1.00)	108.0 (4.25)	31.8 (1.25)

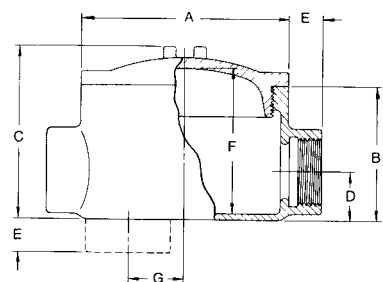
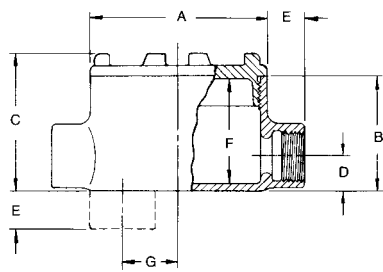

1-1/4" = Form 2  
1-1/2" and 2" = Form 3

♦ In Class I, Division 1, Group B atmospheres, all conduit runs must have a sealing fitting (not supplied) field-installed adjacent to the enclosure.  
 ① Aluminum body and cover only.  
 ② Other covers available—see GR and GRF Conduit Outlet Box Covers page. Order separately.  
 ③ For malleable iron body and cover, add suffix **-M**.  
 ④ Form number designates body and matching cover sizes. To order body without cover, add suffix **-LC** to catalog number.

Appleton

ENCLOSURES AND JUNCTION BOXES: NEC/CEC EXPLOSIONPROOF OUTLET BOXES

# GRF Flanged Conduit Outlet Boxes

## Explosionproof, Dust-Ignitionproof

UNILETS® for use with Threaded Metal Conduit. Furnished with Internal Ground Screw and O-Ring.

**NEC/CEC:**





Class I, Division 1 and 2, Groups B♦, C, D

Class II, Division 1 and 2, Groups E, F, G

Class III

NEMA 3, 4, 4X ①

Class 1, Zone 1 and 2, IIA, IIB

	Hub Type	Conduit Size (Inches)	Cover Opening mm (in)	Capacity dm³ (in³)	Form Number ④	Catalog Number ②	
						Malleable Iron ③ Body With Aluminum Cover	Aluminum Body with Aluminum Cover
	GRFC	1/2	85.9 (3.38)	0.29 (18.0)	1	GRFC50	GRFC50-A
		3/4	85.9 (3.38)	0.29 (18.0)	1	GRFC75	GRFC75-A
		1	85.9 (3.38)	0.29 (18.0)	1	GRFC100	GRFC100-A
	GRFL	1/2	85.9 (3.38)	0.29 (18.0)	1	GRFL50	GRFL50-A
		3/4	85.9 (3.38)	0.29 (18.0)	1	GRFL75	GRFL75-A
		1	85.9 (3.38)	0.29 (18.0)	1	GRFL100	GRFL100-A
	GRFT	1/2	85.9 (3.38)	0.29 (18.0)	1	GRFT50	GRFT50-A
		3/4	85.9 (3.38)	0.29 (18.0)	1	GRFT75	GRFT75-A
		1	85.9 (3.38)	0.29 (18.0)	1	GRFT100	GRFT100-A
	GRFX	1/2	85.9 (3.38)	0.29 (18.0)	1	GRFX50	GRFX50-A
		3/4	85.9 (3.38)	0.29 (18.0)	1	GRFX75	GRFX75-A
		1	85.9 (3.38)	0.29 (18.0)	1	GRFX100	GRFX100-A

**Dimensions in Millimeters (Inches)**

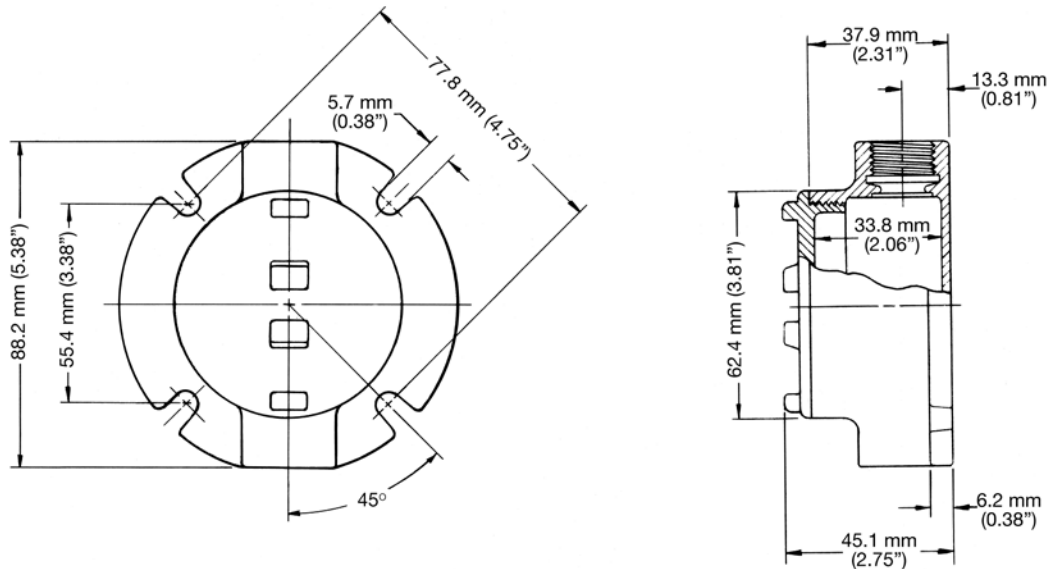

♦ In Class I, Division 1, Group B atmospheres, all conduit runs must have a sealing fitting (not supplied) field-installed adjacent to the enclosure.

① Aluminum body and cover only.

② Other covers available—see GR and GRF Conduit Outlet Box Covers page. Order separately.

③ For malleable iron body and cover, add suffix **-M**.

④ Form number designates body and matching cover sizes. To order body without cover, add suffix **-LC** to catalog number.

Visit our website at [www.emerson.com](http://www.emerson.com) or contact us at (800) 621-1506.

© May 2016

# GR and GRF Conduit Outlet Box Covers

## Explosionproof, Dust-Ignitionproof

Covers and O-rings Fit Bodies with Corresponding Form Numbers.

### NEC/CEC:







Class I, Division 1 and 2, Groups B♦, C, D

Class II, Division 1 and 2, Groups E, F, G

Class III

NEMA 3, 4, 4X ①

Class 1, Zone 1 and 2, IIA, IIB

Hub Type	Cover Opening mm (in)	Fixture Stem Size mm (in)	Form Number ②	Catalog Number	
				Malleable Iron	Aluminum
 Surface	85.9 (3.38)	—	1	<b>GRK-1M</b>	<b>GRK-1</b>
	100.1 (3.94)	—	2	<b>GRK-2M</b>	<b>GRK-2</b>
	124.0 (4.88)	—	3	<b>GRK-3M</b>	<b>GRK-3</b>
 Sealing Class I, Groups C & D	85.9 (3.38)	—	1	<b>GRK-1SC</b>	<b>GRK-1SC-A</b>
	100.1 (3.94)	—	2	<b>GRK-2SC</b>	<b>GRK-2SC-A</b>
	124.0 (4.88)	—	3	<b>GRK-3SC</b>	<b>GRK-3SC-A</b>
 2" Deep Dome UL Listed: E185964 6 Cubic Inches	85.9 (3.38)	—	1	—	<b>GRK-1DC</b>
 Union Hub	85.9 (3.38)	19.1 (0.75)	1	<b>GRK-75U</b>	<b>GRK-75UA</b>
 Hub	85.9 (3.38)	12.7 (0.50)	1	<b>GRK-50</b>	<b>GRK-50A</b>
	85.9 (3.38)	19.1 (0.75)	1	<b>GRK-75</b>	<b>GRK-75A</b>
 Canopy Length 4-1/2" Class I, Group D 16 Cubic Inches	85.9 (3.38)	12.7 (0.50)	1	<b>GRK-50C</b>	—
	85.9 (3.38)	19.1 (0.75)	1	<b>GRK-75C</b>	—
	85.9 (3.38)	25.4 (1.00)	1	<b>GRK-100C</b>	—

### Catalog Number

### O-Rings — Buna-N

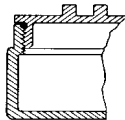

Provide Raintight fit when used on following series:  
 GR (Forms 1, 2 and 3), GRF (Form 1), GRH, and GRU  
 (Form 1).

1	<b>GRG-1</b>
2	<b>GRG-2</b>
3	<b>GRG-3</b>

### GRTB Terminal Strip



For use in standard GR series boxes Weidmuller type MK terminal block ③ with wire range of #22-#12 AWG.  
 Mounts on 2 Pre-Drilled and tapped standard holes (furnished in internal GR boxes).

6 position terminal block kit	1+2	<b>GRTB6-12</b>
6 position terminal block kit	3	<b>GRTB6-3</b>
12 position terminal block kit	3	<b>GRTB12-3</b>

♦ In Class I, Division 1, Group B atmospheres, all conduit runs must have a sealing fitting (not supplied) field-installed adjacent to the enclosure.

① Aluminum body and cover only.

② Form numbers designate cover and matching body sizes.

③ Terminal block is UL listed for 300 Volt, 25 Amp. CSA certified for 300 Volt, 13 Amp.