

FM7™ Conduit Outlet Bodies, Covers and Gaskets

For use with Rigid Steel, Rigid Aluminum and IMC Conduit.

NEC/CEC — Suitable for use in the following
Hazardous Locations:
Class I, Division 2 per NEC 501.10(B)(4)

Applications

- Serve as pulling fittings.
- Make bends in conduit system.
- Provide openings for splicing.
- Connect and change direction of conduit runs.
- Allow connections for branch runs.
- Permit access to conductors for maintenance.

Features

- Smooth, rounded integral bushings in hubs protect conductor insulation.
- Accurately tapped, tapered threads for tight, rigid joints and excellent ground continuity.
- Wedge-Lok™ Form-IN-Place covers with integral gasket are approved for use in wet locations. Grayloy-iron bodies with cast covers and gasket are approved for use in wet locations.
- Unique Wedge-Lok™ clip cover design allows easy removal at any later time, without damaging the conduit body. The cover is secured with clips, not screws.
- Completely interchangeable with Crouse-Hinds™ Form 7™ bodies, gaskets and covers. Equivalent FM7™ and Form 7™ units have identical applications and installation dimensions.
- Flat back design provides greater cubic content for easier wire pulling, and more room for splicing. Fits flush and snug against flat surfaces for more stable installation.
- Smooth hub bushings and cover openings protect conductor insulation. Smooth hub openings allow easy conduit joining.
- Pan-head cover screws secure cover clips and provide superior screwdriver seating and torque. Cover screws and clips are captive to prevent loss.
- Hub size, body style, compliance data, maximum wire number/size and cubic capacity molded into body.

Standard Materials

- Body: Grayloy-iron or copperfree (4/10 of 1% max.) aluminum
- Covers: Grayloy-iron, copperfree (4/10 of 1% max.) aluminum or steel
- Cover screws: stainless steel

Standard Finishes

- Grayloy-iron bodies and covers: triplecoat — (1) zinc electroplate, (2) chromate, and (3) epoxy powder coat
- Cast aluminum bodies and covers: epoxy powder coat
- Steel covers: zinc electroplate
- Stamped aluminum covers: natural finish

Options

- PVC coating available on select bodies and covers. Add suffix **-PVC** to catalog number.

NEC/GEC Certifications and Compliances

- UL Standard: 514A , 514B
- UL Listed: E2527
- CSA Standard: C22.2 No. 18.3
- CSA Certified: 065183
- NEMA Standard: FB-1



Type LB

Illustrated Features



Conduit Body with Cast Aluminum Cover, 1" Type C shown



Grayloy™-Iron, 1" Type C shown with cut-away body and cover to illustrate Wedge-Lok™ Clip Cover detail

Illustrated views are cut away to demonstrate back configurations.



Appleton™ FM7™ (C57, 1-1/2")
28 Cubic Inches Capacity
Flat-Back Design



Crouse-Hinds Form 7™
(C57, 1-1/2")
26 Cubic Inches Capacity



† Crouse-Hinds and Form 7™ are registered trademarks of Cooper Crouse-Hinds.



FM7™ Conduit Outlet Bodies, Covers and Gaskets

For use with Rigid Steel, Rigid Aluminum and IMC Conduit.

NEC/CEC — Suitable for use in the following
Hazardous Locations:
Class I, Division 2 per NEC 501.10(B)(4)

Appleton™ FM7™ Conduit Bodies ①

Hub Size (Inches)	Max. Wire Fill	C		Max. Wire Fill	LB		Max. Wire Fill	LL	
		Grayloy-Iron	Aluminum ④		Grayloy-Iron	Aluminum ④		Grayloy-Iron	Aluminum ④
									
1/2	③	C17	C-17SA	③	LB17	LB-17SA	③	LL17	LL-17SA
3/4	(3) # 6	C27	C-27SA	(3) # 6	LB27	LB-27SA	(3) # 6	LL27	LL-27SA
1	(3) # 4	C37	C-37SA	(3) # 4	LB37	LB-37SA	(3) # 4	LL37	LL-37SA
1-1/4	(3) # 3	C47	C-47SA	(3) # 3	LB47	LB-47SA	(3) # 2	LL47	LL-47SA
1-1/2	(3) # 3	C57	C-57SA	(3) # 3	LB57	LB-57SA	(3) # 2	LL57	LL-57SA
2	(3) # 1/0	C67	C-67SA	(3) # 1/0	LB67	LB-67SA	(3) # 3/0	LL67	LL-67SA
2-1/2	(3) 2/0	C77	C-77SA	(3) 3/0	LB77	LB-77SA	(3) 250	LL77	LL-77SA
3	(3) 2/0	C87	C-87SA	(3) 2/0	LB87	LB-87SA	(3) 250	LL87	LL-87SA
3-1/2	—	—	—	(3) 300	LB97	LB-97SA	(3) 350	LL97	LL-97SA
4	—	—	—	(3) 350	LB107	LB-107SA	(3) 350	LL107	LL-107SA

Hub Size (Inches)	Max. Wire Fill	E		Max. Wire Fill	L ②		Max. Wire Fill	TA	
		Grayloy-Iron	Aluminum		Grayloy-Iron	Aluminum ④		Grayloy-Iron	Aluminum
									
1/2	③	E17	E-17SA	③	L17	—	③	TA17	—
3/4	(3) # 6	E27	E-27SA	(3) # 6	L27	—	(3) # 6	TA27	—
1	(3) # 4	E37	E-37SA	(3) # 4	L37	—	(3) # 4	TA37	—
1-1/4	—	—	—	(3) # 2	L47	—	(3) # 3	TA47	—
1-1/2	—	—	—	(3) # 2	L57	—	(3) # 2	TA57	—
2	—	—	—	(3) # 2	L67	—	(3) # 2	TA67	—



① Refer to following pages for Wiring Capacity Table.
② L Unilets have double opening and are furnished with one steel cover, assembled.
③ All 1/2" Max Wire Fill Calculations per the NEC - Annex C - Table C8.
④ PVC coating available on select aluminum bodies. Add suffix **-PVC** to catalog number.



FM7™ Conduit Outlet Bodies, Covers and Gaskets

For use with Rigid Steel, Rigid Aluminum and IMC Conduit.

NEC/CEC — Suitable for use in the following
Hazardous Locations:
Class I, Division 2 per NEC 501.10(B)(4)

Appleton™ FM7™ Conduit Bodies ①

Hub Size (Inches)	Max. Wire Fill	LR		Max. Wire Fill	T	
		Grayloy-Iron	Aluminum ③		Grayloy-Iron	Aluminum ③
						
1/2	②	LR17	LR-17SA	②	T17	T-17SA
3/4	(3) # 6	LR27	LR-27SA	(3) # 6	T27	T-27SA
1	(3) # 4	LR37	LR-37SA	(3) # 4	T37	T-37SA
1-1/4	(3) # 2	LR47	LR-47SA	(3) # 3	T47	T-47SA
1-1/2	(3) # 2	LR57	LR-57SA	(3) # 3	T57	T-57SA
2	(3) # 2	LR67	LR-67SA	(3) # 2	T67	T-67SA
2-1/2	—	LR77	LR-77SA	(3) 1/0	T77	T-77SA
3	(3) 250	LR87	LR-87SA	(3) 1/0	T87	T-87SA
3-1/2	(3) 350	LR97	LR-97SA	(3) 3/0	T97	T-97SA
4	(3) 350	LR107	LR-107SA	(3) 3/0	T107	T-107SA

Hub Size (Inches)	Max. Wire Fill	TB		Max. Wire Fill	X	
		Grayloy-Iron	Aluminum ③		Grayloy-Iron	Aluminum ③
						
1/2	②	TB17	TB-17SA	②	X17	X-17SA
3/4	(3) # 6	TB27	TB-27SA	(3) # 6	X27	X-27SA
1	(3) # 4	TB37	TB-37SA	(3) # 4	X37	X-37SA
1-1/4	(3) # 3	TB47	TB-47SA	(3) # 3	X47	X-47SA
1-1/2	(3) # 2	TB57	TB-57SA	(3) # 2	X57	X-57SA
2	(3) # 2	TB67	TB-67SA	(3) # 2	X67	X-67SA

① Refer to following pages for Wiring Capacity Table.

② All 1/2" Max Wire Fill Calculations per the NEC - Annex C - Table C8.



③ PVC coating available on select aluminum bodies. Add suffix **-PVC** to catalog number.

FM7™ Conduit Outlet Bodies, Covers and Gaskets

For use with Rigid Steel, Rigid Aluminum and IMC Conduit.

NEC/CEC — Suitable for use in the following
Hazardous Locations:
Class I, Division 2 per NEC 501.10(B)(4)

Wedge-Lok™ Clip Covers, Gaskets *(Covers furnished with stainless steel screws)*

Body Size(Inches)	Wedge-Lok Cast Cover		Wedge-Lok Stamped Cover		Solid Neoprene Gasket
	Grayloy-Iron	Aluminum	Steel	Aluminum ①	
					
1/2	170F	170F-SA	170	170-SA	GASK571
3/4	270F	270F-SA	270	270-SA	GASK572
1	370F	370F-SA	370	370-SA	GASK573
1-1/4	470F	470F-SA	470	470-SA	GASK574
1-1/2	570F	570F-SA	570	570-SA	GASK575
2	670F	670F-SA	670	670-SA	GASK576
2-1/2	870F	870F-SA	870	870-SA	GASK578
3	870F	870F-SA	870	870-SA	GASK578
3-1/2	970F	970F-SA	970	970-SA	GASK579
4	970F	970F-SA	970	970-SA	GASK579

① PVC coating available on select aluminum covers. Add suffix **-PVC** to catalog number.

FM7™ Conduit Outlet Bodies, Covers and Gaskets

For use with Rigid Steel, Rigid Aluminum and IMC Conduit.

NEC/CEC — Suitable for use in the following
Hazardous Locations:
Class I, Division 2 per NEC 501.10(B)(4)

Wiring Capacity: Combine Body and Cover Capacities for Total Usable Capacity per NEC 314.16(A)

Hub Size (Inches)	Capacity — dm ³ (in ³)									Stamped Cover	Cast Cover
	C	E	LB	LL LR	L	T	TA	TB	X		
FM7™ Grayloy™-Iron Bodies and Covers: Threaded											
1/2	0.07 (4.00)	0.07 (4.00)	0.07 (4.00)	0.07 (4.00)	0.08 (5.00)	0.10 (6.00)	0.10 (6.00)	0.10 (6.00)	0.10 (6.00)	0.00 (0.30)	0.01 (0.40)
3/4	0.11 (7.00)	0.11 (7.00)	0.11 (7.00)	0.11 (7.00)	0.15 (9.00)	0.16 (10.00)	0.16 (10.00)	0.16 (10.00)	0.16 (10.00)	0.01 (0.50)	0.01 (0.80)
1	0.18 (11.00)	0.18 (11.00)	0.18 (11.00)	0.18 (11.00)	0.22 (13.50)	0.25 (15.50)	0.25 (15.50)	0.25 (15.50)	0.25 (15.50)	0.02 (1.30)	0.02 (1.30)
1-1/4	0.33 (20.00)	—	0.33 (20.00)	0.33 (20.00)	0.37 (22.50)	0.33 (20.00)	0.33 (20.00)	0.33 (20.00)	0.33 (20.00)	0.03 (1.80)	0.03 (2.00)
1-1/2	0.46 (28.00)	—	0.46 (28.00)	0.46 (28.00)	0.51 (31.00)	0.46 (28.00)	0.46 (28.00)	0.46 (28.00)	0.46 (28.00)	0.04 (2.30)	0.05 (3.00)
2	0.82 (50.00)	—	0.82 (50.00)	0.82 (50.00)	0.82 (50.00)	0.82 (50.00)	0.82 (50.00)	0.82 (50.00)	0.82 (50.00)	0.05 (2.80)	0.08 (4.80)
2-1/2	1.67 (102.00)	—	1.67 (102.00)	1.67 (102.00)	—	1.67 (102.00)	—	—	—	0.16 (9.80)	0.16 (9.70)
3	2.18 (133.00)	—	2.18 (133.00)	2.18 (133.00)	—	2.18 (133.00)	—	—	—	0.16 (9.80)	0.16 (9.70)
3-1/2	—	—	3.57 (218.00)	3.57 (218.00)	—	3.57 (218.00)	—	—	—	0.27 (16.50)	0.26 (16.00)
4	—	—	4.00 (244.00)	4.00 (244.00)	—	4.00 (244.00)	—	—	—	0.27 (16.50)	0.26 (16.00)
FM7™ Aluminum Bodies and Covers: Threaded											
1/2	0.07 (4.00)	0.07 (4.00)	0.07 (4.00)	0.07 (4.00)	—	0.10 (6.00)	—	0.10 (6.00)	0.10 (6.00)	0.005 (0.30)	0.007 (0.40)
3/4	0.11 (7.00)	0.11 (7.00)	0.11 (7.00)	0.11 (7.00)	—	0.16 (10.00)	—	0.16 (10.00)	0.16 (10.00)	0.008 (0.50)	0.01 (0.80)
1	0.18 (11.00)	0.18 (11.00)	0.18 (11.00)	0.18 (11.00)	—	0.25 (15.50)	—	0.25 (15.50)	0.25 (15.50)	0.02 (1.30)	0.02 (1.30)
1-1/4	0.33 (20.00)	—	0.33 (20.00)	0.33 (20.00)	—	0.33 (20.00)	—	0.33 (20.00)	0.33 (20.00)	0.03 (1.80)	0.03 (2.00)
1-1/2	0.46 (28.00)	—	0.46 (28.00)	0.46 (28.00)	—	0.46 (28.00)	—	0.46 (28.00)	0.46 (28.00)	0.04 (2.30)	0.05 (3.00)
2	0.82 (50.00)	—	0.82 (50.00)	0.82 (50.00)	—	0.82 (50.00)	—	0.82 (50.00)	0.82 (50.00)	0.05 (2.80)	0.08 (4.80)
2-1/2	1.67 (102.00)	—	1.67 (102.00)	1.67 (102.00)	—	1.67 (102.00)	—	—	—	0.16 (9.80)	0.16 (9.70)
3	2.18 (133.00)	—	2.18 (133.00)	2.18 (133.00)	—	2.18 (133.00)	—	—	—	0.16 (9.80)	0.16 (9.70)
3-1/2	—	—	3.57 (218.00)	3.57 (218.00)	—	3.57 (218.00)	—	—	—	0.27 (16.50)	0.26 (16.00)
4	—	—	4.00 (244.00)	4.00 (244.00)	—	4.00 (244.00)	—	—	—	0.27 (16.50)	0.26 (16.00)

Appleton

COMMERCIAL AND INDUSTRIAL FITTINGS: CONDUIT BODIES

FM7™ Conduit Outlet Bodies, Covers and Gaskets

FM7™ Covers with Integral Form-In-Place Gasket.

NEC/CEC:
Class I, Division 2
NEMA 3R

Applications

- Cover with integral gasket for FM7™ conduit bodies.
- Can be used as replacement covers for installed bodies or in new installations.

Features

- Benefit from superior sealing, reduced inventory parts and faster installation times.
- Captive pan-head screws.
- Wedge-Lok™ clips (FM7™ only) provide superior screwdriver torque and cover seating.
- High-strength, corrosion and weather resistant.
- Approved for wet locations.
- Fits all body configurations and sizes from 1/2" thru 4".
- Operating temperature: -54 °C to +150 °C (-65 °F to +302 °F).





Standard Materials

- Stamped steel
- Stamped aluminum
- Cast grayloy-iron
- Cast aluminum
- Gasket - Urethane

NEC/CEC Certifications and Compliances

- UL Listed: E2527
- CSA Certified: 65183, Class 4413-02

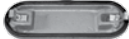

Hub Size (Inches)	Stamped Steel	Stamped Aluminum	Cast Grayloy-Iron	Cast Aluminum
				
1/2	APP170IG	APP170IGSA	APP170FIG	APP170FIGSA
3/4	APP270IG	APP270IGSA	APP270FIG	APP270FIGSA
1	APP370IG	APP370IGSA	APP370FIG	APP370FIGSA
1-1/4	APP470IG	APP470IGSA	APP470FIG	APP470FIGSA
1-1/2	APP570IG	APP570IGSA	APP570FIG	APP570FIGSA
2	APP670IG	APP670IGSA	APP670FIG	APP670FIGSA
2-1/2 and 3	APP870IG	APP870IGSA	APP870FIG	APP870FIGSA
3-1/2 and 4	APP970IG	APP970IGSA	APP970FIG	APP970FIGSA

FM7™ Conduit Outlet Bodies, Covers and Gaskets

For use with Rigid Steel, Rigid Aluminum and IMC Conduit.

NEC/CEC:
Class I, Division 2
NEMA 3R

Dimensions in Millimeters (Inches)

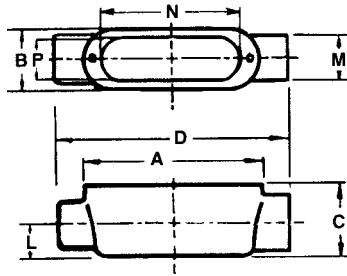

Type C

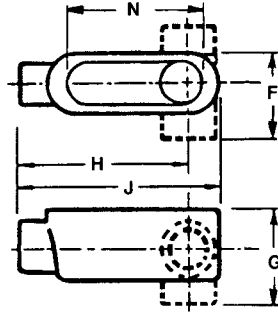

Type E, L, LB, LL, LR

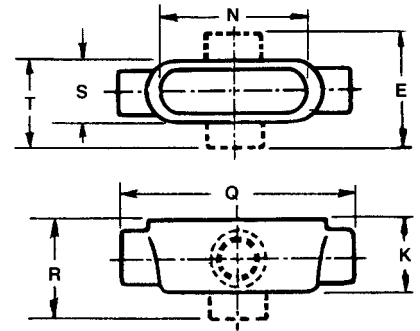

Type T, TA, TB, X

Hub Size (Inches)	Dimensions in Millimeters (Inches)																		
	A	B	C	D	E	F	G	H	J	K	L	M	N	P	Q	R	S	T	
1/2	92.2 (3.63)	35.1 (1.38)	35.1 (1.38)	136.7 (5.38)	84.1 (3.31)	57.2 (2.25)	57.2 (2.25)	100.1 (3.94)	115.8 (4.56)	44.5 (1.75)	16.0 (0.63)	31.8 (1.25)	81.0 (3.19)	23.9 (0.94)	143.0 (5.63)	66.8 (2.63)	39.6 (1.56)	62.0 (2.44)	
3/4	108.0 (4.25)	39.6 (1.56)	41.4 (1.63)	152.4 (6.00)	88.9 (3.50)	62.0 (2.44)	63.5 (2.50)	112.8 (4.44)	131.8 (5.19)	50.8 (2.00)	19.1 (0.75)	38.1 (1.50)	96.8 (3.81)	28.7 (1.13)	158.8 (6.25)	73.2 (2.88)	47.8 (1.88)	66.8 (2.63)	
1	127.0 (5.00)	44.5 (1.75)	47.8 (1.88)	177.8 (7.00)	98.6 (3.88)	69.9 (2.75)	73.2 (2.88)	131.8 (5.19)	152.4 (6.00)	57.2 (2.25)	22.4 (0.88)	44.5 (1.75)	114.3 (4.50)	35.1 (1.38)	184.2 (7.25)	82.6 (3.25)	50.8 (2.00)	76.2 (3.00)	
1-1/4	139.7 (5.50)	55.6 (2.19)	58.7 (2.31)	189.0 (7.44)	104.9 (4.13)	81.0 (3.19)	84.1 (3.31)	138.2 (5.44)	165.1 (6.50)	58.7 (2.31)	28.7 (1.13)	55.6 (2.19)	127.0 (5.00)	44.5 (1.75)	189.0 (7.44)	84.1 (3.31)	55.6 (2.19)	81.0 (3.19)	
1-1/2	152.4 (6.00)	62.0 (2.44)	65.0 (2.56)	208.0 (8.19)	117.6 (4.63)	88.9 (3.50)	93.7 (3.69)	150.9 (5.94)	181.1 (7.13)	65.0 (2.56)	31.8 (1.25)	62.0 (2.44)	138.2 (5.44)	49.3 (1.94)	208.0 (8.19)	92.2 (3.63)	62.0 (2.44)	90.4 (3.56)	
2	177.8 (7.00)	76.2 (3.00)	79.5 (3.13)	233.4 (9.19)	131.8 (5.19)	103.1 (4.06)	108.0 (4.25)	168.4 (6.63)	206.5 (8.13)	79.5 (3.13)	38.1 (1.50)	76.2 (3.00)	162.1 (6.38)	62.0 (2.44)	233.4 (9.19)	106.4 (4.19)	76.2 (3.00)	104.9 (4.13)	
2-1/2	228.6 (9.00)	108.0 (4.25)	92.2 (3.63)	304.8 (12.00)	—	146.1 (5.75)	130.3 (5.13)	222.3 (8.75)	266.7 (10.50)	92.2 (3.63)	44.5 (1.75)	88.9 (3.50)	212.9 (8.38)	90.4 (3.56)	304.8 (12.00)	—	108.0 (4.25)	146.1 (5.75)	
3	228.6 (9.00)	108.0 (4.25)	111.3 (4.38)	304.8 (12.00)	—	146.1 (5.75)	149.4 (5.88)	212.9 (8.38)	266.7 (10.50)	111.3 (4.38)	54.1 (2.13)	108.0 (4.25)	212.9 (8.38)	90.4 (3.56)	306.3 (12.06)	—	108.0 (4.25)	146.1 (5.75)	
3-1/2	279.4 (11.00)	133.4 (5.25)	124.0 (4.88)	—	—	176.3 (6.94)	166.6 (6.56)	260.4 (10.25)	322.3 (12.69)	124.0 (4.88)	60.5 (2.38)	120.7 (4.75)	260.4 (10.25)	114.3 (4.50)	363.5 (14.31)	—	133.4 (5.25)	176.3 (6.94)	
4	279.4 (11.00)	133.4 (5.25)	136.7 (5.38)	—	—	176.3 (6.94)	179.3 (7.06)	254.0 (10.00)	322.3 (12.69)	136.7 (5.38)	66.8 (2.63)	133.4 (5.25)	260.4 (10.25)	114.3 (4.50)	363.5 (14.31)	—	133.4 (5.25)	176.3 (6.94)	

Fraction/Decimal Equivalents (Inches)

Fraction	Decimal	Fraction	Decimal	Fraction	Decimal	Fraction	Decimal
1/16	0.06	5/16	0.31	9/16	0.56	13/16	0.81
1/8	0.13	3/8	0.38	5/8	0.63	7/8	0.88
3/16	0.19	7/16	0.44	11/16	0.69	15/16	0.94
1/4	0.25	1/2	0.50	3/4	0.75	1	1.00

FM7™ Conduit Outlet Bodies, Covers and Gaskets

For use with Rigid Steel, Rigid Aluminum and IMC Conduit.

NEC/CEC — Suitable for use in the following
Hazardous Locations:
Class I, Division 2 per NEC 501.10(B)(4)

Applications

- Serve as pulling fittings.
- Make bends in conduit system.
- Provide openings for splicing.
- Connect and change direction of conduit runs.
- Allow connections for branch runs.
- Permit access to conductors for maintenance.

Features

- Smooth, rounded integral bushings in hubs protect conductor insulation.
- Accurately tapped, tapered threads for tight, rigid joints and excellent ground continuity.
- Wedge-Lok™ Form-IN-Place covers with integral gasket are approved for use in wet locations. Grayloy-iron bodies with cast covers and gasket are approved for use in wet locations.
- Unique Wedge-Lok™ clip cover design allows easy removal at any later time, without damaging the conduit body. The cover is secured with clips, not screws.
- Completely interchangeable with Crouse-Hinds™ Form 7™ bodies, gaskets and covers. Equivalent FM7™ and Form 7™ units have identical applications and installation dimensions.
- Flat back design provides greater cubic content for easier wire pulling, and more room for splicing. Fits flush and snug against flat surfaces for more stable installation.
- Smooth hub bushings and cover openings protect conductor insulation. Smooth hub openings allow easy conduit joining.
- Pan-head cover screws secure cover clips and provide superior screwdriver seating and torque. Cover screws and clips are captive to prevent loss.
- Hub size, body style, compliance data, maximum wire number/size and cubic capacity molded into body.

Standard Materials

- Body: Grayloy-iron or copperfree (4/10 of 1% max.) aluminum
- Covers: Grayloy-iron, copperfree (4/10 of 1% max.) aluminum or steel
- Cover screws: stainless steel

Standard Finishes

- Grayloy-iron bodies and covers: triplecoat — (1) zinc electroplate, (2) chromate, and (3) epoxy powder coat
- Cast aluminum bodies and covers: epoxy powder coat
- Steel covers: zinc electroplate
- Stamped aluminum covers: natural finish

Options

- PVC coating available on select bodies and covers. Add suffix **-PVC** to catalog number.

NEC/GEC Certifications and Compliances

- UL Standard: 514A , 514B
- UL Listed: E2527
- CSA Standard: C22.2 No. 18.3
- CSA Certified: 065183
- NEMA Standard: FB-1



Type LB

Illustrated Features



Conduit Body with Cast Aluminum Cover, 1" Type C shown



Grayloy™-Iron, 1" Type C shown with cut-away body and cover to illustrate Wedge-Lok™ Clip Cover detail

Illustrated views are cut away to demonstrate back configurations.



Appleton™ FM7™ (C57, 1-1/2")
28 Cubic Inches Capacity
Flat-Back Design



Crouse-Hinds Form 7™
(C57, 1-1/2")
26 Cubic Inches Capacity



† Crouse-Hinds and Form 7™ are registered trademarks of Cooper Crouse-Hinds.



FM7™ Conduit Outlet Bodies, Covers and Gaskets

For use with Rigid Steel, Rigid Aluminum and IMC Conduit.

NEC/CEC — Suitable for use in the following
Hazardous Locations:
Class I, Division 2 per NEC 501.10(B)(4)

Appleton™ FM7™ Conduit Bodies ①

Hub Size (Inches)	Max. Wire Fill	C		Max. Wire Fill	LB		Max. Wire Fill	LL	
		Grayloy-Iron	Aluminum ④		Grayloy-Iron	Aluminum ④		Grayloy-Iron	Aluminum ④
									
1/2	③	C17	C-17SA	③	LB17	LB-17SA	③	LL17	LL-17SA
3/4	(3) # 6	C27	C-27SA	(3) # 6	LB27	LB-27SA	(3) # 6	LL27	LL-27SA
1	(3) # 4	C37	C-37SA	(3) # 4	LB37	LB-37SA	(3) # 4	LL37	LL-37SA
1-1/4	(3) # 3	C47	C-47SA	(3) # 3	LB47	LB-47SA	(3) # 2	LL47	LL-47SA
1-1/2	(3) # 3	C57	C-57SA	(3) # 3	LB57	LB-57SA	(3) # 2	LL57	LL-57SA
2	(3) # 1/0	C67	C-67SA	(3) # 1/0	LB67	LB-67SA	(3) # 3/0	LL67	LL-67SA
2-1/2	(3) 2/0	C77	C-77SA	(3) 3/0	LB77	LB-77SA	(3) 250	LL77	LL-77SA
3	(3) 2/0	C87	C-87SA	(3) 2/0	LB87	LB-87SA	(3) 250	LL87	LL-87SA
3-1/2	—	—	—	(3) 300	LB97	LB-97SA	(3) 350	LL97	LL-97SA
4	—	—	—	(3) 350	LB107	LB-107SA	(3) 350	LL107	LL-107SA

Hub Size (Inches)	Max. Wire Fill	E		Max. Wire Fill	L ②		Max. Wire Fill	TA	
		Grayloy-Iron	Aluminum		Grayloy-Iron	Aluminum ④		Grayloy-Iron	Aluminum
									
1/2	③	E17	E-17SA	③	L17	—	③	TA17	—
3/4	(3) # 6	E27	E-27SA	(3) # 6	L27	—	(3) # 6	TA27	—
1	(3) # 4	E37	E-37SA	(3) # 4	L37	—	(3) # 4	TA37	—
1-1/4	—	—	—	(3) # 2	L47	—	(3) # 3	TA47	—
1-1/2	—	—	—	(3) # 2	L57	—	(3) # 2	TA57	—
2	—	—	—	(3) # 2	L67	—	(3) # 2	TA67	—



① Refer to following pages for Wiring Capacity Table.
② L Unilets have double opening and are furnished with one steel cover, assembled.
③ All 1/2" Max Wire Fill Calculations per the NEC - Annex C - Table C8.
④ PVC coating available on select aluminum bodies. Add suffix **-PVC** to catalog number.



FM7™ Conduit Outlet Bodies, Covers and Gaskets

For use with Rigid Steel, Rigid Aluminum and IMC Conduit.

NEC/CEC — Suitable for use in the following
Hazardous Locations:
Class I, Division 2 per NEC 501.10(B)(4)

Appleton™ FM7™ Conduit Bodies ①

Hub Size (Inches)	Max. Wire Fill	LR		Max. Wire Fill	T		
		Grayloy-Iron	Aluminum ③		Grayloy-Iron	Aluminum ③	
							
1/2	②	LR17	LR-17SA	②	T17	T-17SA	
3/4	(3) # 6	LR27	LR-27SA	(3) # 6	T27	T-27SA	
1	(3) # 4	LR37	LR-37SA	(3) # 4	T37	T-37SA	
1-1/4	(3) # 2	LR47	LR-47SA	(3) # 3	T47	T-47SA	
1-1/2	(3) # 2	LR57	LR-57SA	(3) # 3	T57	T-57SA	
2	(3) # 2	LR67	LR-67SA	(3) # 2	T67	T-67SA	
2-1/2	—	LR77	LR-77SA	(3) 1/0	T77	T-77SA	
3	(3) 250	LR87	LR-87SA	(3) 1/0	T87	T-87SA	
3-1/2	(3) 350	LR97	LR-97SA	(3) 3/0	T97	T-97SA	
4	(3) 350	LR107	LR-107SA	(3) 3/0	T107	T-107SA	

Hub Size (Inches)	Max. Wire Fill	TB		Max. Wire Fill	X		
		Grayloy-Iron	Aluminum ③		Grayloy-Iron	Aluminum ③	
							
1/2	②	TB17	TB-17SA	②	X17	X-17SA	
3/4	(3) # 6	TB27	TB-27SA	(3) # 6	X27	X-27SA	
1	(3) # 4	TB37	TB-37SA	(3) # 4	X37	X-37SA	
1-1/4	(3) # 3	TB47	TB-47SA	(3) # 3	X47	X-47SA	
1-1/2	(3) # 2	TB57	TB-57SA	(3) # 2	X57	X-57SA	
2	(3) # 2	TB67	TB-67SA	(3) # 2	X67	X-67SA	

① Refer to following pages for Wiring Capacity Table.

② All 1/2" Max Wire Fill Calculations per the NEC - Annex C - Table C8.



③ PVC coating available on select aluminum bodies. Add suffix **-PVC** to catalog number.

FM7™ Conduit Outlet Bodies, Covers and Gaskets

For use with Rigid Steel, Rigid Aluminum and IMC Conduit.

NEC/CEC — Suitable for use in the following
Hazardous Locations:
Class I, Division 2 per NEC 501.10(B)(4)

Wedge-Lok™ Clip Covers, Gaskets *(Covers furnished with stainless steel screws)*

Body Size(Inches)	Wedge-Lok Cast Cover		Wedge-Lok Stamped Cover		Solid Neoprene Gasket
	Grayloy-Iron	Aluminum	Steel	Aluminum ①	
					
1/2	170F	170F-SA	170	170-SA	GASK571
3/4	270F	270F-SA	270	270-SA	GASK572
1	370F	370F-SA	370	370-SA	GASK573
1-1/4	470F	470F-SA	470	470-SA	GASK574
1-1/2	570F	570F-SA	570	570-SA	GASK575
2	670F	670F-SA	670	670-SA	GASK576
2-1/2	870F	870F-SA	870	870-SA	GASK578
3	870F	870F-SA	870	870-SA	GASK578
3-1/2	970F	970F-SA	970	970-SA	GASK579
4	970F	970F-SA	970	970-SA	GASK579

① PVC coating available on select aluminum covers. Add suffix **-PVC** to catalog number.

FM7™ Conduit Outlet Bodies, Covers and Gaskets

For use with Rigid Steel, Rigid Aluminum and IMC Conduit.

NEC/CEC — Suitable for use in the following
Hazardous Locations:
Class I, Division 2 per NEC 501.10(B)(4)

Wiring Capacity: Combine Body and Cover Capacities for Total Usable Capacity per NEC 314.16(A)

Hub Size (Inches)	Capacity — dm ³ (in ³)									Stamped Cover	Cast Cover	
	C	E	LB	LL LR	L	T	TA	TB	X			
FM7™ Grayloy™-Iron Bodies and Covers: Threaded												
1/2	0.07 (4.00)	0.07 (4.00)	0.07 (4.00)	0.07 (4.00)	0.08 (5.00)	0.10 (6.00)	0.10 (6.00)	0.10 (6.00)	0.10 (6.00)	0.10 (6.00)	0.00 (0.30)	0.01 (0.40)
3/4	0.11 (7.00)	0.11 (7.00)	0.11 (7.00)	0.11 (7.00)	0.15 (9.00)	0.16 (10.00)	0.16 (10.00)	0.16 (10.00)	0.16 (10.00)	0.16 (10.00)	0.01 (0.50)	0.01 (0.80)
1	0.18 (11.00)	0.18 (11.00)	0.18 (11.00)	0.18 (11.00)	0.22 (13.50)	0.25 (15.50)	0.25 (15.50)	0.25 (15.50)	0.25 (15.50)	0.25 (15.50)	0.02 (1.30)	0.02 (1.30)
1-1/4	0.33 (20.00)	—	0.33 (20.00)	0.33 (20.00)	0.37 (22.50)	0.33 (20.00)	0.33 (20.00)	0.33 (20.00)	0.33 (20.00)	0.33 (20.00)	0.03 (1.80)	0.03 (2.00)
1-1/2	0.46 (28.00)	—	0.46 (28.00)	0.46 (28.00)	0.51 (31.00)	0.46 (28.00)	0.46 (28.00)	0.46 (28.00)	0.46 (28.00)	0.46 (28.00)	0.04 (2.30)	0.05 (3.00)
2	0.82 (50.00)	—	0.82 (50.00)	0.82 (50.00)	0.82 (50.00)	0.82 (50.00)	0.82 (50.00)	0.82 (50.00)	0.82 (50.00)	0.82 (50.00)	0.05 (2.80)	0.08 (4.80)
2-1/2	1.67 (102.00)	—	1.67 (102.00)	1.67 (102.00)	—	1.67 (102.00)	—	—	—	—	0.16 (9.80)	0.16 (9.70)
3	2.18 (133.00)	—	2.18 (133.00)	2.18 (133.00)	—	2.18 (133.00)	—	—	—	—	0.16 (9.80)	0.16 (9.70)
3-1/2	—	—	3.57 (218.00)	3.57 (218.00)	—	3.57 (218.00)	—	—	—	—	0.27 (16.50)	0.26 (16.00)
4	—	—	4.00 (244.00)	4.00 (244.00)	—	4.00 (244.00)	—	—	—	—	0.27 (16.50)	0.26 (16.00)
FM7™ Aluminum Bodies and Covers: Threaded												
1/2	0.07 (4.00)	0.07 (4.00)	0.07 (4.00)	0.07 (4.00)	—	0.10 (6.00)	—	0.10 (6.00)	0.10 (6.00)	0.10 (6.00)	0.005 (0.30)	0.007 (0.40)
3/4	0.11 (7.00)	0.11 (7.00)	0.11 (7.00)	0.11 (7.00)	—	0.16 (10.00)	—	0.16 (10.00)	0.16 (10.00)	0.16 (10.00)	0.008 (0.50)	0.01 (0.80)
1	0.18 (11.00)	0.18 (11.00)	0.18 (11.00)	0.18 (11.00)	—	0.25 (15.50)	—	0.25 (15.50)	0.25 (15.50)	0.25 (15.50)	0.02 (1.30)	0.02 (1.30)
1-1/4	0.33 (20.00)	—	0.33 (20.00)	0.33 (20.00)	—	0.33 (20.00)	—	0.33 (20.00)	0.33 (20.00)	0.33 (20.00)	0.03 (1.80)	0.03 (2.00)
1-1/2	0.46 (28.00)	—	0.46 (28.00)	0.46 (28.00)	—	0.46 (28.00)	—	0.46 (28.00)	0.46 (28.00)	0.46 (28.00)	0.04 (2.30)	0.05 (3.00)
2	0.82 (50.00)	—	0.82 (50.00)	0.82 (50.00)	—	0.82 (50.00)	—	0.82 (50.00)	0.82 (50.00)	0.82 (50.00)	0.05 (2.80)	0.08 (4.80)
2-1/2	1.67 (102.00)	—	1.67 (102.00)	1.67 (102.00)	—	1.67 (102.00)	—	—	—	—	0.16 (9.80)	0.16 (9.70)
3	2.18 (133.00)	—	2.18 (133.00)	2.18 (133.00)	—	2.18 (133.00)	—	—	—	—	0.16 (9.80)	0.16 (9.70)
3-1/2	—	—	3.57 (218.00)	3.57 (218.00)	—	3.57 (218.00)	—	—	—	—	0.27 (16.50)	0.26 (16.00)
4	—	—	4.00 (244.00)	4.00 (244.00)	—	4.00 (244.00)	—	—	—	—	0.27 (16.50)	0.26 (16.00)

FM7™ Conduit Outlet Bodies, Covers and Gaskets

FM7™ Covers with Integral Form-In-Place Gasket.

NEC/CEC:
Class I, Division 2
NEMA 3R

Applications

- Cover with integral gasket for FM7™ conduit bodies.
- Can be used as replacement covers for installed bodies or in new installations.

Features

- Benefit from superior sealing, reduced inventory parts and faster installation times.
- Captive pan-head screws.
- Wedge-Lok™ clips (FM7™ only) provide superior screwdriver torque and cover seating.
- High-strength, corrosion and weather resistant.
- Approved for wet locations.
- Fits all body configurations and sizes from 1/2" thru 4".
- Operating temperature: -54 °C to +150 °C (-65 °F to +302 °F).





Standard Materials

- Stamped steel
- Stamped aluminum
- Cast grayloy-iron
- Cast aluminum
- Gasket - Urethane

NEC/CEC Certifications and Compliances

- UL Listed: E2527
- CSA Certified: 65183, Class 4413-02

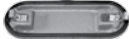

Hub Size (Inches)	Stamped Steel	Stamped Aluminum	Cast Grayloy-Iron	Cast Aluminum
				
1/2	APP170IG	APP170IGSA	APP170FIG	APP170FIGSA
3/4	APP270IG	APP270IGSA	APP270FIG	APP270FIGSA
1	APP370IG	APP370IGSA	APP370FIG	APP370FIGSA
1-1/4	APP470IG	APP470IGSA	APP470FIG	APP470FIGSA
1-1/2	APP570IG	APP570IGSA	APP570FIG	APP570FIGSA
2	APP670IG	APP670IGSA	APP670FIG	APP670FIGSA
2-1/2 and 3	APP870IG	APP870IGSA	APP870FIG	APP870FIGSA
3-1/2 and 4	APP970IG	APP970IGSA	APP970FIG	APP970FIGSA

FM7™ Conduit Outlet Bodies, Covers and Gaskets

For use with Rigid Steel, Rigid Aluminum and IMC Conduit.

NEC/CEC:
Class I, Division 2
NEMA 3R

Dimensions in Millimeters (Inches)

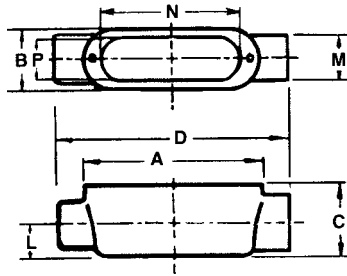

Type C

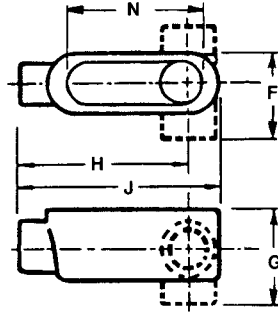

Type E, L, LB, LL, LR

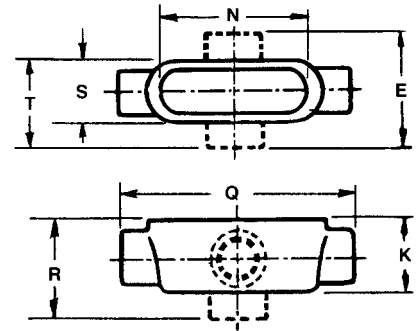

Type T, TA, TB, X

Hub Size (Inches)	Dimensions in Millimeters (Inches)																		
	A	B	C	D	E	F	G	H	J	K	L	M	N	P	Q	R	S	T	
1/2	92.2 (3.63)	35.1 (1.38)	35.1 (1.38)	136.7 (5.38)	84.1 (3.31)	57.2 (2.25)	57.2 (2.25)	100.1 (3.94)	115.8 (4.56)	44.5 (1.75)	16.0 (0.63)	31.8 (1.25)	81.0 (3.19)	23.9 (0.94)	143.0 (5.63)	66.8 (2.63)	39.6 (1.56)	62.0 (2.44)	
3/4	108.0 (4.25)	39.6 (1.56)	41.4 (1.63)	152.4 (6.00)	88.9 (3.50)	62.0 (2.44)	63.5 (2.50)	112.8 (4.44)	131.8 (5.19)	50.8 (2.00)	19.1 (0.75)	38.1 (1.50)	96.8 (3.81)	28.7 (1.13)	158.8 (6.25)	73.2 (2.88)	47.8 (1.88)	66.8 (2.63)	
1	127.0 (5.00)	44.5 (1.75)	47.8 (1.88)	177.8 (7.00)	98.6 (3.88)	69.9 (2.75)	73.2 (2.88)	131.8 (5.19)	152.4 (6.00)	57.2 (2.25)	22.4 (0.88)	44.5 (1.75)	114.3 (4.50)	35.1 (1.38)	184.2 (7.25)	82.6 (3.25)	50.8 (2.00)	76.2 (3.00)	
1-1/4	139.7 (5.50)	55.6 (2.19)	58.7 (2.31)	189.0 (7.44)	104.9 (4.13)	81.0 (3.19)	84.1 (3.31)	138.2 (5.44)	165.1 (6.50)	58.7 (2.31)	28.7 (1.13)	55.6 (2.19)	127.0 (5.00)	44.5 (1.75)	189.0 (7.44)	84.1 (3.31)	55.6 (2.19)	81.0 (3.19)	
1-1/2	152.4 (6.00)	62.0 (2.44)	65.0 (2.56)	208.0 (8.19)	117.6 (4.63)	88.9 (3.50)	93.7 (3.69)	150.9 (5.94)	181.1 (7.13)	65.0 (2.56)	31.8 (1.25)	62.0 (2.44)	138.2 (5.44)	49.3 (1.94)	208.0 (8.19)	92.2 (3.63)	62.0 (2.44)	90.4 (3.56)	
2	177.8 (7.00)	76.2 (3.00)	79.5 (3.13)	233.4 (9.19)	131.8 (5.19)	103.1 (4.06)	108.0 (4.25)	168.4 (6.63)	206.5 (8.13)	79.5 (3.13)	38.1 (1.50)	76.2 (3.00)	162.1 (6.38)	62.0 (2.44)	233.4 (9.19)	106.4 (4.19)	76.2 (3.00)	104.9 (4.13)	
2-1/2	228.6 (9.00)	108.0 (4.25)	92.2 (3.63)	304.8 (12.00)	—	146.1 (5.75)	130.3 (5.13)	222.3 (8.75)	266.7 (10.50)	92.2 (3.63)	44.5 (1.75)	88.9 (3.50)	212.9 (8.38)	90.4 (3.56)	304.8 (12.00)	—	108.0 (4.25)	146.1 (5.75)	
3	228.6 (9.00)	108.0 (4.25)	111.3 (4.38)	304.8 (12.00)	—	146.1 (5.75)	149.4 (5.88)	212.9 (8.38)	266.7 (10.50)	111.3 (4.38)	54.1 (2.13)	108.0 (4.25)	212.9 (8.38)	90.4 (3.56)	306.3 (12.06)	—	108.0 (4.25)	146.1 (5.75)	
3-1/2	279.4 (11.00)	133.4 (5.25)	124.0 (4.88)	—	—	176.3 (6.94)	166.6 (6.56)	260.4 (10.25)	322.3 (12.69)	124.0 (4.88)	60.5 (2.38)	120.7 (4.75)	260.4 (10.25)	114.3 (4.50)	363.5 (14.31)	—	133.4 (5.25)	176.3 (6.94)	
4	279.4 (11.00)	133.4 (5.25)	136.7 (5.38)	—	—	176.3 (6.94)	179.3 (7.06)	254.0 (10.00)	322.3 (12.69)	136.7 (5.38)	66.8 (2.63)	133.4 (5.25)	260.4 (10.25)	114.3 (4.50)	363.5 (14.31)	—	133.4 (5.25)	176.3 (6.94)	

Fraction/Decimal Equivalents (Inches)

Fraction	Decimal	Fraction	Decimal	Fraction	Decimal	Fraction	Decimal
1/16	0.06	5/16	0.31	9/16	0.56	13/16	0.81
1/8	0.13	3/8	0.38	5/8	0.63	7/8	0.88
3/16	0.19	7/16	0.44	11/16	0.69	15/16	0.94
1/4	0.25	1/2	0.50	3/4	0.75	1	1.00