

# ACCESSORIES



# GENUINE EUROBEX ACCESSORIES

Choose your Eurobex accessories

Visit  
www.  
eurobex  
.com  
for details.

Call us  
toll free  
1-800-363-  
2423



**Commercial  
Lock inserts**  
p.339



**Commercial  
Key & pad locks**  
p.340



**Commercial  
Door handles**  
p.340



**Commercial  
Lock accessories**  
p.340



**ESCH style  
Locks & inserts**  
p.341



**Industrial  
Lock inserts**  
p.343



**Industrial  
Key & pad locks**  
p.344



**Industrial  
Door handles**  
p.344



**Industrial  
Lock accessories**  
p.345



**Individual cams,  
Inserts & housings**  
p.345



**Stainless steel  
Lock inserts**  
p.347



**Stainless steel  
Key & pad locks**  
p.346



**Stainless steel  
Handles**  
p.346



**Cabinet  
Handles**  
p.348



**Electronic  
Lock devices**  
p.66



**Gear  
Boxes**  
p.350



**Mounting  
Feet & stands**  
p.351



**Cabinet  
Door**  
p.352

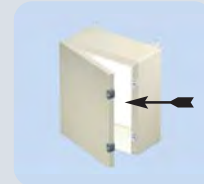

**Cabinet  
Panels**  
p.354

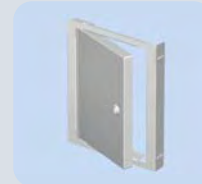

**Swing out  
Panels**  
p.358

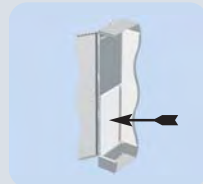

**Side  
Panels**  
p.359



**Lights and  
Accessories**  
p.360

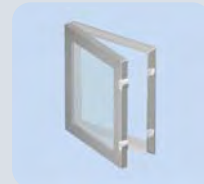

**Hinged & fixed  
Window kits**  
p.364



**Door stop  
Kits**  
p.365



**External  
Drip shields**  
p.365

# GENUINE EUROBEX ACCESSORIES

Choose your Eurobex accessories



**Folding Shelves**  
p.366



**Pole Mounting kits**  
p.366



**Inner panel Depth adjustor**  
p.366



**Print Pockets**  
p.367



**Castor Wheels**  
p.368



**Industrial Eye bolts**  
p.368



**Touch up Paint**  
p.368



**Grounding Accessories**  
p.369



**Hole Plugs**  
p.370



**Hardware Kits**  
p.371



**Gas spring Cylinders**  
p.371

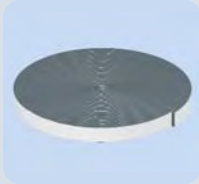

**Self-adhesive Gasket tape**  
p.371



**DIN rails and Accessories**  
p.374

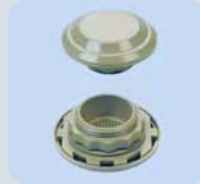

**Pressure Compensation**  
p.375



**Thermostats, Hygrostats**  
p.376

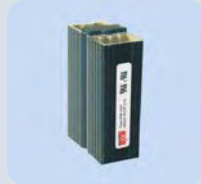

**Enclosure Heaters**  
p.378



**Louver plates, Filters**  
p.382



**Filter fans (Indoor use)**  
p.384



**Filter fans (Outdoor use)**  
p.395

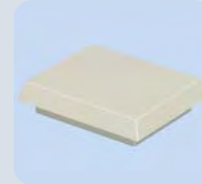

**Top mounted Exhaust filters**  
p.398



# ES SERIES DOOR LOCKS AND HANDLES

## Industrial door locks - 880 SCQ4 series

Visit  
[www.eurobex.com](http://www.eurobex.com)  
for details.

Call us  
toll free  
1-800-363-2423

The **880 SCQ4** series door accessories were designed to fit Eurobex 'ES' style industrial enclosures. A full range of accessories are available to accommodate a variety of applications.

These accessories include :  
- 14 types of lock inserts (p.343)  
- Key lock, padlock and combination lock provisions (p.344)  
- Operating handles (p.344)  
- ¼ turn lock dust cap (p.345)...

Locking mechanisms can be ordered as complete units or in parts. Parts include individual inserts, cams and housings.

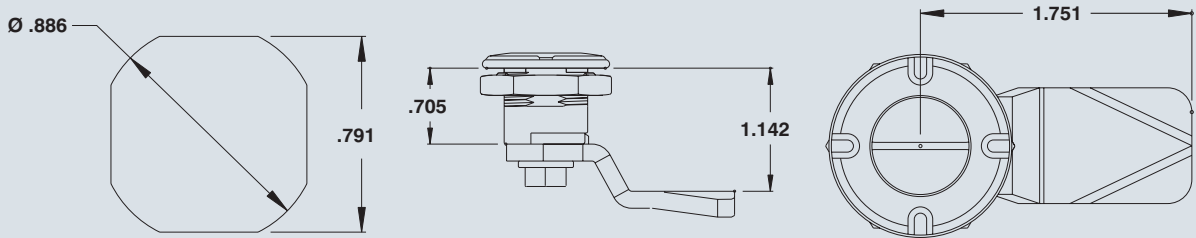

Available accessories, amongst others :



**Lock inserts**  
p.343



**Key locks**  
p.344



**Combination locks**  
p.344



**Padlocks**  
p.344



**'L' handles**  
p.344



**'T' handles**  
p.344



**Wing handles**  
p.344



**Wing padlock**  
p.344



**Interior handle**  
p.344



**Dust cap**  
p.345

The 880 SCQ4 accessories are to be used with these enclosure series, amongst others :



**5100 ES**  
**5412 ES**

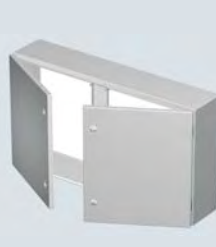

**5100 ESDD**  
**5412 ESDD**



**5412 DDS**



**9412**



**5412 ESA**

# ES SERIES DOOR LOCKS AND HANDLES

Tool operated locking mechanisms, industrial & standard

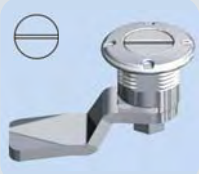

**Slot 2 X 4mm lock**  
**CATALOG # :** 880 SCQ4-SL  
**KEY NUMBER :** None  
**Key included? :** N/A  
**Material :** Steel/Zinc Cast  
**For use with :** ES series, 9412  
 ESA, 5412 ESDD...



**Square 6mm**  
**CATALOG # :** 880 SCQ4-SQ6  
**KEY NUMBER :** K-SQ6  
**Key included? :** No  
**Material :** Steel/Zinc Cast  
**For use with :** ES series, 9412  
 ESA, 5412 ESDD...



**Square 7mm**  
**CATALOG # :** 880 SCQ4-SQ7  
**KEY NUMBER :** K-SQ7  
**Key included? :** No  
**Material :** Steel/Zinc Cast  
**For use with :** ES series, 9412  
 ESA, 5412 ESDD...



**Square 8mm**  
**CATALOG # :** 880 SCQ4-SQ8  
**KEY NUMBER :** K-SQ8  
**Key included? :** No  
**Material :** Steel/Zinc Cast  
**For use with :** ES series, 9412  
 ESA, 5412 ESDD...



**Triangular 7mm**  
**CATALOG # :** 880 SCQ4-TR7  
**KEY NUMBER :** K-TR7  
**Key included? :** No  
**Material :** Steel/Zinc Cast  
**For use with :** ES series, 9412  
 ESA, 5412 ESDD...



**Triangular 8mm**  
**CATALOG # :** 880 SCQ4-TR8  
**KEY NUMBER :** K-TR8  
**Key included? :** No  
**Material :** Steel/Zinc Cast  
**For use with :** ES series, 9412  
 ESA, 5412 ESDD...



**Double bit 3mm**  
**CATALOG # :** 880 SCQ4-DB3  
**KEY NUMBER :** K-DB3  
**Key included? :** No  
**Material :** Steel/Zinc Cast  
**For use with :** ES series, 9412  
 ESA, 5412 ESDD...



**Double bit 5mm**  
**CATALOG # :** 880 SCQ4-DB5  
**KEY NUMBER :** K-DB5  
**Key included? :** No  
**Material :** Steel/Zinc Cast  
**For use with :** ES series, 9412  
 ESA, 5412 ESDD...



**Hexagon 10mm**  
**CATALOG # :** 880 SCQ4-HX  
**KEY NUMBER :** K-HX  
**Key included? :** No  
**Material :** Steel/Zinc Cast  
**For use with :** ES series, 9412  
 ESA, 5412 ESDD...



**Hexagon with pin**  
**CATALOG # :** 880 SCQ4-HXP  
**KEY NUMBER :** K-HXP  
**Key included? :** No  
**Material :** Steel/Zinc Cast  
**For use with :** ES series, 9412  
 ESA, 5412 ESDD...



**Slot 2 X 4mm coinproof**  
**CATALOG # :** 880 SCQ4-SLP  
**KEY NUMBER :** None  
**Key included? :** No  
**Material :** Steel/Zinc Cast  
**For use with :** ES series, 9412  
 ESA, 5412 ESDD...



**Crown type**  
**CATALOG # :** 880 SCQ4-CW  
**KEY NUMBER :** K-CW  
**Key included? :** No  
**Material :** Steel/Zinc Cast  
**For use with :** ES series, 9412  
 ESA, 5412 ESDD...



**Daimler Benz type**  
**CATALOG # :** 880 SCQ4-BZ  
**KEY NUMBER :** K-BZ  
**Key included? :** No  
**Material :** Steel/Zinc Cast  
**For use with :** ES series, 9412  
 ESA, 5412 ESDD...



**Anti-vibration double bit**  
**CATALOG # :** 880 SCQ4-AV  
**KEY NUMBER :** K-DB5  
**Key included? :** No  
**Material :** Steel/Zinc Cast  
**For use with :** ES series, 9412  
 ESA, 5412 ESDD...

Items listed above are complete units. Individual parts (inserts, cams, housings) can be ordered. See page 345.

Data subject to change without notice.

Visit  
www.  
eurobex  
.com  
for details.

Call us  
toll free  
1-800-363-  
2423

## ES SERIES DOOR LOCKS AND HANDLES

'ES' style key locks, pad locks and combination locks



### Key lock

CATALOG # : 880 SCQ4-K  
KEY NUMBER : K-KL1  
Key included? : Yes  
Material : Plated steel  
For use with : ES series, 9412  
ESA, 5412 ESDD...



### Combination lock

CATALOG # : 880 SCQ4-NL  
KEY NUMBER : None  
Key included? : No  
Material : Plated steel  
For use with : ES series, 9412  
ESA, 5412 ESDD...



### Padlock provisions

CATALOG # : 880 PLESQ375  
KEY NUMBER : Padlock  
Key included? : No  
Material : Stainless steel  
For use with : ES series, 9412  
ESA, 5412 ESDD...



### Weatherproof padlock 3/8"

CATALOG # : 880 PDLK375  
KEY NUMBER : K-KL1  
Key included? : Yes  
Material : Steel/Plastic  
For use with : 880 PLESQ38  
General purpose



### General purpose padlock

CATALOG # : 880 PL  
KEY NUMBER : Use padlock  
Key included? : No  
Material : Plated steel  
For use with : ES series, 9412  
ESA, 5412 ESDD...



### Stainless steel padlock

CATALOG # : 880 PLSS  
KEY NUMBER : Use padlock  
Key included? : No  
Material : Stainless steel  
For use with : ES series, 9412  
ESA, 5412 ESDD...

## Industrial door handles



### Key lock 'L' handle

1 point lock : 880 SCQ4-L  
3 point lock : 885 ESL2A  
KEY NUMBER : K-KL1  
Key included? : Yes  
Material : Zinc Cast  
For use with : ES series, 9412



### Key lock 'T' handle

CATALOG # : 880 SCQ4-T  
KEY NUMBER : K-T  
Key included? : Yes  
Material : Polyamide GF/Zinc  
For use with : ES series, 9412  
ESA, 5412 ESDD...



### Key lock wing handle

CATALOG # : 880 SCQ4-WN  
KEY NUMBER : K-WN  
Key included? : Yes  
Material : Polyamide GF/Zinc  
For use with : ES series, 9412  
ESA, 5412 ESDD...

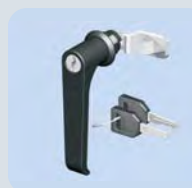

### Key lock straight handle

CATALOG # : 880 SCQ4-SH  
KEY NUMBER : K-SH  
Key included? : Yes  
Material : Polyamide GF/Zinc  
For use with : ES series, 9412  
ESA, 5412 ESDD...



### Wing knob

CATALOG # : 880 SCQ4-WNH  
KEY NUMBER : None  
Key included? : No  
Material : Polyamide GF/Zinc  
For use with : ES series, 9412  
ESA, 5412 ESDD...



### Star handle

CATALOG # : 880 SCQ4-STH  
KEY NUMBER : None  
Key included? : No  
Material : Polyamide GF/Zinc  
For use with : ES series, 9412  
ESA, 5412 ESDD...



### Interior handle

CATALOG # : 880 SCQ4-DIH  
KEY NUMBER : None  
\* Cannot be used with key lock.  
Material : Red polyamide  
For use with : ES series, 9412  
ESA, 5412 ESDD...



### Padlockable wing handle

CATALOG # : 880 SCQ4-WNP  
KEY NUMBER : Padlock  
Key included? : No  
Material : Polyamide GF/Zinc  
For use with : ES series, 9412  
ESA, 5412 ESDD...

# ES SERIES DOOR LOCKS AND HANDLES

## Industrial European styling 1/4 turn lock



European slot lock

CATALOG # : 880 SCQ4-DSL  
 KEY NUMBER : None  
 Key included? : No  
 Material : Polyamide GF/Zinc  
 For use with : ES series, 9412  
 ESA, 5412 ESDD...



European lock w/inserts

European style 1/4 turn locks are available with inserts upon request. These insert types are available :  
 Square      Triangular      Double bit  
 Hexagone      Coinproof      Crown  
 Daimler      East Europe      ...

## Accessories for industrial 1/4 turn locks



1/4 turn lock dust cap

CATALOG # : 880 DDC  
 KEY NUMBER : None  
 Key included? : No  
 Material : Polyamide GF  
 For use with : ES series, 9412  
 ESA, 5412 ESDD...



Finger pull for 1/4 turn lock

CATALOG # : 880 DFP  
 KEY NUMBER : None  
 Key included? : No  
 Material : Polyamide GF  
 For use with : ES series, 9412  
 ESA, 5412 ESDD...

## Parts for quarter turn locks - Cams, inserts, housings

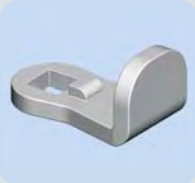

Commercial cam

CATALOG # : 880 SCQCOM-CAM  
 KEY NUMBER : None  
 Key included? : No  
 Material : Steel  
 For use with : Commercial and industrial boxes



Industrial cam ('ES' series)

CATALOG # : 880 SCQ4-CAM  
 KEY NUMBER : None  
 Key included? : No  
 Material : Steel  
 For use with : ES series, 9412  
 ESA, 5412 ESDD...



Cam for 1500 CH throughs

CATALOG # : 880 SCQ4-CAMCH  
 KEY NUMBER : None  
 Key included? : No  
 Material : Zinc Cast  
 For use with : 1500 CH throughs



Industrial cam ('ESW')

CATALOG # : 880 SCQ4-CAMW  
 KEY NUMBER : None  
 Key included? : No  
 Material : Zinc Cast  
 For use with : 5412 ESW  
 5412 ESSW

DESCRIPTION	CATALOG NUMBERS FOR INDIVIDUAL INSERTS AND HOUSINGS		
	CHROME PLATED ZINC CAST	STAINLESS STEEL TYPE 304	STAINLESS STEEL TYPE 316
Slot 2 X 4 mm insert	880 ISL	880 ISLSS4	880 ISLSS6
Slot 1,2 X 3 insert	880 ISL2	--	--
Square 6 mm insert	880 ISQ6	880 ISQ6SS4	--
Square 7 mm insert	880 ISQ7	880 ISQ7SS4	880 ISQ7SS6
Square 8 mm insert	880 ISQ8	880 ISQ8SS4	880 ISQ8SS6
Square 8 mm slotted	880 ISQS	--	--
Triangular 7 mm insert	880 ITR7	880 ITR7SS4	880 ITR7SS6
Triangular 8 mm insert	880 ITR8	880 ITR8SS4	880 ITR8SS6
Triangular 9 mm insert	880 ITR9	--	--
Triangular 10 mm insert	80 ITR10	--	--
Double bit 3 mm insert	880 IDB3	880 IDB3SS4	880 IDB3SS6
Double bit 5 mm insert	880 IDB5	880 IDB5SS4	880 IDB5SS6
Hexagon 10 mm insert	880 IHX	--	--
Hexagon insert with pin	880 IHXP	880 IHXPSS4	--
Slot 2 X 4 mm coinproof	880 ISLP	--	--
Crown type insert	880 ICW	--	--
Daimler Benz insert	880 IBZ	--	--
Eastern Europe Ø13	880 IEE	880 IEESS4	--
Fiat type insert	880 IFIAT	--	--
Lock housing	880 SCQH	880 SCQHSS	--

Other inserts, cams and housings available upon request. Call Eurobex at 1-800-363-2423 for more information.

Data subject to change without notice.

# CABINET HANDLES

## Cabinet handles

Visit  
www.  
eurobex  
.com  
for details.

Call us  
toll free  
1-800-363-  
2423

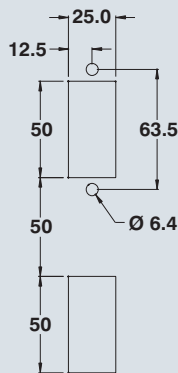

In addition to the standard slot and key lock, these inserts are available for the 885 ESL3 and 885 ESL4



Square 8mm



Square 7mm



Triangular 8mm



Triangular 7mm



Double bit 5mm



Double bit 3mm

Other inserts available upon request.



The **880 APH** automotive padlockable handle was designed to fit most type 4-12 enclosures. The handle is available with a key insert or spring loaded defeater, requiring a tool in order to operate the mechanism for disconnect requirements. A unique padlock trigger ensures positive closing. The handle can incorporate your company logo. Finish is textured black.

CATALOG NUMBER	DESCRIPTION	SHIP WGHT LBS.
880 APH-K	Key lock	2
880 APH-D	Slotted defeater	2

Note : Trigger is designed to fit 1/4" and 5/16" padlocks.



The **885 ESL3** seal type door handle was designed to fit most type 4-12 enclosures. The handle is available with a key insert, a standard slot screw driver insert or a variety of other inserts. The 885 ESL3 are used when there is a need for a swivel handle with a seal provision. A protective dust cap is provided. Locks are rated NEMA Type 4. Finish is textured black.

CATALOG NUMBER	DESCRIPTION	SHIP WGHT LBS.
885 ESL3K	Key lock	1
885 ESL3S	Screw driver slot	1
885 ESL3SQ7	Square 7mm	1
885 ESL3SQ8	Square 8mm	1
885 ESL3TR7	Triangular 7mm	1
885 ESL3TR8	Triangular 8mm	1
885 ESL3DB3	Double bit 3mm	1
885 ESL3DB5	Double bit 5mm	1
885 ESL3B	Blank	1



The **885 ESL4** seal type handle was designed to fit most type 4-12 enclosures. The handle is available with a key insert, a standard slot screw driver insert or a variety of other inserts. The 885 ESL4 are used when there is a need for a swivel handle with a padlock provision. This handle accommodates a 1/4" padlock. Locks are rated NEMA Type 4. Finish is textured black.

CATALOG NUMBER	DESCRIPTION	SHIP WGHT LBS.
885 ESL4K	Key lock	1
885 ESL4S	Screw driver slot	1
885 ESL4SQ7	Square 7mm	1
885 ESL4SQ8	Square 8mm	1
885 ESL4TR7	Triangular 7mm	1
885 ESL4TR8	Triangular 8mm	1
885 ESL4DB3	Double bit 3mm	1
885 ESL4DB5	Double bit 5mm	1
885 ESL4B	Blank	1

Data subject to change without notice.



# CABINET HANDLES, PULL DOWN HASPS



The **880 PH** padlockable handles are used for outdoor application. This sturdy handle is made of chrome plated steel or of stainless steel. Comes complete with installation hardware and gasket.

CATALOG NUMBER	DESCRIPTION	SHIP WGHT LBS.
880 PH	Chrome plated steel	1
880 PHSS	Stainless steel	1



The **886 ELKPX** electronic keypad system grants access to an enclosure upon entry of the correct code on the keypad. The handle can be used standalone, in electronic master-slave systems and remote access control systems.

*Please see page 66 for details.*

**For detailed information on the E.line electromechanical lock system, please see page 66.**



The **886 ELIT** transponder handle is opened using transponder devices. The handle can be used standalone, in electronic master-slave systems and remote access control systems.

*Please see page 66 for details.*

**For detailed information on the E.line electromechanical lock system, please see page 66.**

## Pull down hasps



### Pull down padlock hasp

CATALOG # : 883 CM1  
 KEY NUMBER : Use padlock  
 Key included? : No  
 Material : Plated steel  
 For use with : 1300 H,  
 1500 Lay-in ducts



### SS Pull down padlock hasp

CATALOG # : 883 CM1SS  
 KEY NUMBER : Use padlock  
 Key included? : No  
 Material : Stainless steel  
 For use with : 5412 ESFRQ,  
 1300 H, 1500 SS



### SS Pull down padlock hasp

CATALOG # : 883 CM2  
 KEY NUMBER : Use padlock  
 Key included? : No  
 Material : Stainless steel  
 For use with : 5300 ES

Data subject to change without notice.

# GEAR BOX AND LATCH RODS

## Gear boxes - Series 885 GBOX

Visit  
[www.eurobex.com](http://www.eurobex.com)  
for details.

Call us  
toll free  
1-800-363-2423

The **885 GBOX** gear boxes are used with Eurobex door locks as three point latch locking mechanisms. Three versions of 885 GBOX exist, each corresponding to a particular Eurobex door lock.



CATALOG NUMBER	FOR USE WITH	SHIP WGHT LBS.
885 GBOX1	880 PH series	1



CATALOG NUMBER	FOR USE WITH	SHIP WGHT LBS.
885 GBOX2	885 ESL2A, 880 APH	1



CATALOG NUMBER	FOR USE WITH	SHIP WGHT LBS.
885 GBOX3	885 ESL3, 885 ESL4	1

## Latching rods for 5500 and 9500 series

The **CBAR series** is used as part of a three point latching mechanism in the 5412, 5500 and 9500 series enclosures. The CBAR's can be used as replacement parts or to build a custom latching mechanism.

**881 CBAR** latching rods fit 5500 ESDD series cabinets and large 5412 ES cabinets (height  $\geq 42$ ").

**885 CBAR** latching rods fit 5500 DDS series cabinets.

**889 CBAR** latching rods fit 9500 series cabinets.



CATALOG NUMBER	FOR USE WITH	SHIP WGHT LBS.
881 CBAR24	24" height	1
881 CBAR30	30" height	1
881 CBAR36	36" height	2
881 CBAR42	42" height	3
881 CBAR48	48" height	3
881 CBAR54	54" height	3
881 CBAR60	60" height	3
881 CBAR72	72" height	3



CATALOG NUMBER	FOR USE WITH	SHIP WGHT LBS.
885 CBAR60	60" height	3
885 CBAR72	72" height	3

CATALOG NUMBER	FOR USE WITH	SHIP WGHT LBS.
889 CBAR60	60" height	3
889 CBAR72	72" height	3
889 CBAR84	84" height	3
889 CBAR90	90" height	3

Data subject to change without notice.

# MOUNTING FEET, FLOOR STANDS

## Mounting feet for small and medium-sized enclosures



**JIC Wall mounting feet**  
**CATALOG # :** 885 ESCHMF  
 Four mounting feet & hardware incl.  
 Mounted vertically or horizontally.  
**Material :** Zinc cast  
**For use with :** ESCH series,  
 1100, ESSC...



**'ESFR' Wall mounting feet**  
**CATALOG # :** 885 ESFRMF  
 Four mounting feet & hardware incl.  
 Mounted vertically or horizontally.  
**Material :** Plastic  
**For use with :** ESFRS, ESFRH,  
 ESFRQ



**'ES' Wall mounting feet**  
**CATALOG # :** 885 ESMF1  
 Four mounting feet & hardware incl.  
 Mounted vertically or horizontally.  
**Material :** Plated steel  
**For use with :** ES series, ESDD,  
 5300 MC, ESA, ESY



**SS Wall mounting feet**  
**CATALOG # :** 885 ESMF2  
 Four mounting feet & hardware incl.  
 Mounted vertically or horizontally.  
**Material :** Stainless steel  
**For use with :** ESS series, ESSDD  
 ESSA, ESSY...



**Offset mounting feet 0.5"**  
**CATALOG # :** 885 ESOMF1  
 Four mounting feet & hardware incl.  
 Mounted vertically or horizontally.  
**Material :** Plated steel  
**For use with :** ES series, ESDD,  
 5300 MC, ESA, ESY



**SS offset mounting feet 0.5"**  
**CATALOG # :** 885 ESOMF2  
 Four mounting feet & hardware incl.  
 Mounted vertically or horizontally.  
**Material :** Stainless steel  
**For use with :** ESS series, ESSDD  
 ESSA, ESSY...



**Offset mounting feet 1.5"**  
**CATALOG # :** 885 ESOMF1A  
 Four mounting feet & hardware incl.  
 Mounted vertically or horizontally.  
**Material :** Plated steel  
**For use with :** ES series, ESDD,  
 5300 MC, ESA, ESY



**SS offset mounting feet 1.5"**  
**CATALOG # :** 885 ESOMF2A  
 Four mounting feet & hardware incl.  
 Mounted vertically or horizontally.  
**Material :** Stainless steel  
**For use with :** ESS series, ESSDD  
 ESSA, ESSY...

## 5412 & 5500 series floor mounting stands

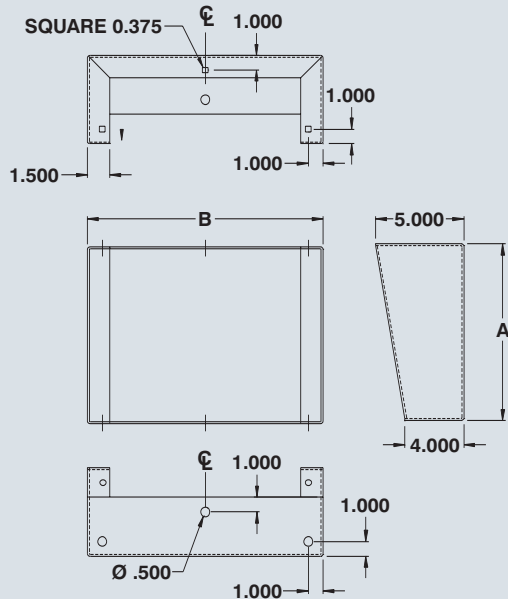

The 885 MF - Floor mounting feet are made from 14 GA steel, pre-drilled for fixation to the floor and to the bottom of the 5412 and 5500 series enclosures. Kits come complete with all necessary hardware. Mounting feet are finished with heat fused polyester powder, electrostatically applied on a phosphatized base. Finish is ANSI/ASA 61 gray.

CATALOG NUMBER	DIMENSIONS		SHIP WGT LBS.	CATALOG NUMBER	DIMENSIONS		SHIP WGT LBS.
	A	B			A	B	
885 MF0606	6	6	14	885 MF1516	15	16	37
885 MF0608	6	8	16	885 MF1520	15	20	44
885 MF0610	6	10	17	885 MF1524	15	24	45
885 MF0612	6	12	18	885 MF1806	18	6	28
885 MF0616	6	16	21	885 MF1808	18	8	32
885 MF0620	6	20	25	885 MF1810	18	10	36
885 MF0624	6	24	28	885 MF1812	18	12	41
885 MF1206	12	6	21	885 MF1816	18	16	47
885 MF1208	12	8	23	885 MF1820	18	20	49
885 MF1210	12	10	26	885 MF1824	18	24	51
885 MF1212	12	12	32	885 MF2406	24	6	38
885 MF1216	12	16	35	885 MF2408	24	8	40
885 MF1220	12	20	40	885 MF2410	24	10	45
885 MF1224	12	24	42	885 MF2412	24	12	50
885 MF1506	15	6	23	885 MF2416	24	16	58
885 MF1508	15	8	25	885 MF2420	24	20	65
885 MF1510	15	10	28	885 MF2424	24	24	70
885 MF1512	15	12	34	* Add suffix 'SS' for stainless.			

Data subject to change without notice.