

ACCESSORIES



GENUINE EUROBEX ACCESSORIES

Choose your Eurobex accessories

Visit
www.
eurobex
.com
for details.

Call us
toll free
1-800-363-
2423



**Commercial
Lock inserts**
p.339



**Commercial
Key & pad locks**
p.340



**Commercial
Door handles**
p.340



**Commercial
Lock accessories**
p.340



**ESCH style
Locks & inserts**
p.341



**Industrial
Lock inserts**
p.343



**Industrial
Key & pad locks**
p.344



**Industrial
Door handles**
p.344



**Industrial
Lock accessories**
p.345



**Individual cams,
Inserts & housings**
p.345



**Stainless steel
Lock inserts**
p.347



**Stainless steel
Key & pad locks**
p.346



**Stainless steel
Handles**
p.346



**Cabinet
Handles**
p.348



**Electronic
Lock devices**
p.66



**Gear
Boxes**
p.350



**Mounting
Feet & stands**
p.351



**Cabinet
Door**
p.352

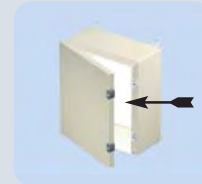

**Cabinet
Panels**
p.354

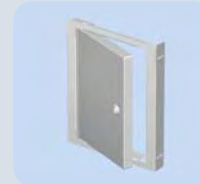

**Swing out
Panels**
p.358

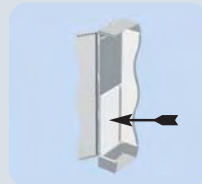

**Side
Panels**
p.359



**Lights and
Accessories**
p.360

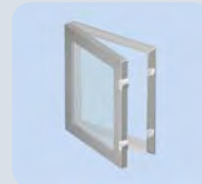

**Hinged & fixed
Window kits**
p.364



**Door stop
Kits**
p.365



**External
Drip shields**
p.365

GENUINE EUROBEX ACCESSORIES

Choose your Eurobex accessories



Folding Shelves
p.366



Pole Mounting kits
p.366



Inner panel Depth adjustor
p.366



Print Pockets
p.367



Castor Wheels
p.368



Industrial Eye bolts
p.368



Touch up Paint
p.368



Grounding Accessories
p.369



Hole Plugs
p.370

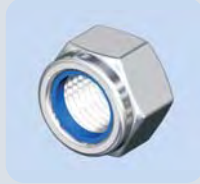

Hardware Kits
p.371



Gas spring Cylinders
p.371

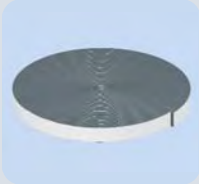

Self-adhesive Gasket tape
p.371



DIN rails and Accessories
p.374

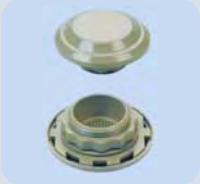

Pressure Compensation
p.375



Thermostats, Hygrostats
p.376

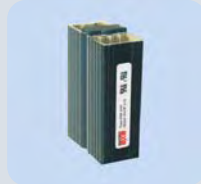

Enclosure Heaters
p.378



Louver plates, Filters
p.382



Filter fans (Indoor use)
p.384



Filter fans (Outdoor use)
p.395

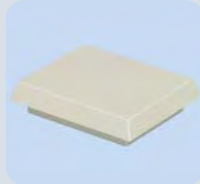

Top mounted Exhaust filters
p.398



Data subject to change without notice.

ES SERIES DOOR LOCKS AND HANDLES

Industrial door locks - 880 SCQ4 series

Visit www.eurobex.com for details.

Call us toll free 1-800-363-2423

The **880 SCQ4** series door accessories were designed to fit Eurobex 'ES' style industrial enclosures. A full range of accessories are available to accommodate a variety of applications.

These accessories include :
 - 14 types of lock inserts (p.343)
 - Key lock, padlock and combination lock provisions (p.344)
 - Operating handles (p.344)
 - ¼ turn lock dust cap (p.345)...

Locking mechanisms can be ordered as complete units or in parts. Parts include individual inserts, cams and housings.

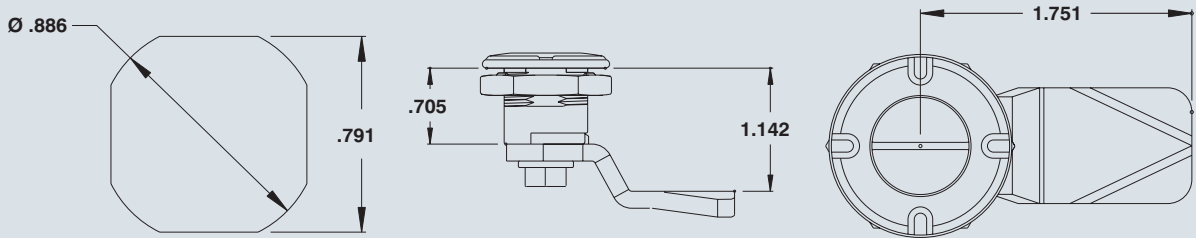

Available accessories, amongst others :



Lock inserts
p.343



Key locks
p.344



Combination locks
p.344



Padlocks
p.344



'L' handles
p.344



'T' handles
p.344



Wing handles
p.344



Wing padlock
p.344



Interior handle
p.344



Dust cap
p.345

The 880 SCQ4 accessories are to be used with these enclosure series, amongst others :



5100 ES
5412 ES



5100 ESDD
5412 ESDD



5412 DDS



9412



5412 ESA

Data subject to change without notice.

ES SERIES DOOR LOCKS AND HANDLES

Tool operated locking mechanisms, industrial & standard



Slot 2 X 4mm lock
CATALOG # : 880 SCQ4-SL
KEY NUMBER : None
Key included? : N/A
Material : Steel/Zinc Cast
For use with : ES series, 9412
 ESA, 5412 ESDD...



Square 6mm
CATALOG # : 880 SCQ4-SQ6
KEY NUMBER : K-SQ6
Key included? : No
Material : Steel/Zinc Cast
For use with : ES series, 9412
 ESA, 5412 ESDD...



Square 7mm
CATALOG # : 880 SCQ4-SQ7
KEY NUMBER : K-SQ7
Key included? : No
Material : Steel/Zinc Cast
For use with : ES series, 9412
 ESA, 5412 ESDD...



Square 8mm
CATALOG # : 880 SCQ4-SQ8
KEY NUMBER : K-SQ8
Key included? : No
Material : Steel/Zinc Cast
For use with : ES series, 9412
 ESA, 5412 ESDD...



Triangular 7mm
CATALOG # : 880 SCQ4-TR7
KEY NUMBER : K-TR7
Key included? : No
Material : Steel/Zinc Cast
For use with : ES series, 9412
 ESA, 5412 ESDD...



Triangular 8mm
CATALOG # : 880 SCQ4-TR8
KEY NUMBER : K-TR8
Key included? : No
Material : Steel/Zinc Cast
For use with : ES series, 9412
 ESA, 5412 ESDD...



Double bit 3mm
CATALOG # : 880 SCQ4-DB3
KEY NUMBER : K-DB3
Key included? : No
Material : Steel/Zinc Cast
For use with : ES series, 9412
 ESA, 5412 ESDD...



Double bit 5mm
CATALOG # : 880 SCQ4-DB5
KEY NUMBER : K-DB5
Key included? : No
Material : Steel/Zinc Cast
For use with : ES series, 9412
 ESA, 5412 ESDD...



Hexagon 10mm
CATALOG # : 880 SCQ4-HX
KEY NUMBER : K-HX
Key included? : No
Material : Steel/Zinc Cast
For use with : ES series, 9412
 ESA, 5412 ESDD...



Hexagon with pin
CATALOG # : 880 SCQ4-HXP
KEY NUMBER : K-HXP
Key included? : No
Material : Steel/Zinc Cast
For use with : ES series, 9412
 ESA, 5412 ESDD...



Slot 2 X 4mm coinproof
CATALOG # : 880 SCQ4-SLP
KEY NUMBER : None
Key included? : No
Material : Steel/Zinc Cast
For use with : ES series, 9412
 ESA, 5412 ESDD...



Crown type
CATALOG # : 880 SCQ4-CW
KEY NUMBER : K-CW
Key included? : No
Material : Steel/Zinc Cast
For use with : ES series, 9412
 ESA, 5412 ESDD...



Daimler Benz type
CATALOG # : 880 SCQ4-BZ
KEY NUMBER : K-BZ
Key included? : No
Material : Steel/Zinc Cast
For use with : ES series, 9412
 ESA, 5412 ESDD...



Anti-vibration double bit
CATALOG # : 880 SCQ4-AV
KEY NUMBER : K-DB5
Key included? : No
Material : Steel/Zinc Cast
For use with : ES series, 9412
 ESA, 5412 ESDD...

Items listed above are complete units. Individual parts (inserts, cams, housings) can be ordered. See page 345.

Data subject to change without notice.

Visit
www.
eurobex
.com
for details.

Call us
toll free
1-800-363-
2423

ES SERIES DOOR LOCKS AND HANDLES

'ES' style key locks, pad locks and combination locks



Key lock

CATALOG # : 880 SCQ4-K
KEY NUMBER : K-KL1
Key included? : Yes
Material : Plated steel
For use with : ES series, 9412
ESA, 5412 ESDD...



Combination lock

CATALOG # : 880 SCQ4-NL
KEY NUMBER : None
Key included? : No
Material : Plated steel
For use with : ES series, 9412
ESA, 5412 ESDD...



Padlock provisions

CATALOG # : 880 PLESQ375
KEY NUMBER : Padlock
Key included? : No
Material : Stainless steel
For use with : ES series, 9412
ESA, 5412 ESDD...



Weatherproof padlock 3/8"

CATALOG # : 880 PDLK375
KEY NUMBER : K-KL1
Key included? : Yes
Material : Steel/Plastic
For use with : 880 PLESQ38
General purpose



General purpose padlock

CATALOG # : 880 PL
KEY NUMBER : Use padlock
Key included? : No
Material : Plated steel
For use with : ES series, 9412
ESA, 5412 ESDD...



Stainless steel padlock

CATALOG # : 880 PLSS
KEY NUMBER : Use padlock
Key included? : No
Material : Stainless steel
For use with : ES series, 9412
ESA, 5412 ESDD...

Industrial door handles



Key lock 'L' handle

1 point lock : 880 SCQ4-L
3 point lock : 885 ESL2A
KEY NUMBER : K-KL1
Key included? : Yes
Material : Zinc Cast
For use with : ES series, 9412



Key lock 'T' handle

CATALOG # : 880 SCQ4-T
KEY NUMBER : K-T
Key included? : Yes
Material : Polyamide GF/Zinc
For use with : ES series, 9412
ESA, 5412 ESDD...



Key lock wing handle

CATALOG # : 880 SCQ4-WN
KEY NUMBER : K-WN
Key included? : Yes
Material : Polyamide GF/Zinc
For use with : ES series, 9412
ESA, 5412 ESDD...



Key lock straight handle

CATALOG # : 880 SCQ4-SH
KEY NUMBER : K-SH
Key included? : Yes
Material : Polyamide GF/Zinc
For use with : ES series, 9412
ESA, 5412 ESDD...



Wing knob

CATALOG # : 880 SCQ4-WNH
KEY NUMBER : None
Key included? : No
Material : Polyamide GF/Zinc
For use with : ES series, 9412
ESA, 5412 ESDD...



Star handle

CATALOG # : 880 SCQ4-STH
KEY NUMBER : None
Key included? : No
Material : Polyamide GF/Zinc
For use with : ES series, 9412
ESA, 5412 ESDD...



Interior handle

CATALOG # : 880 SCQ4-DIH
KEY NUMBER : None
* Cannot be used with key lock.
Material : Red polyamide
For use with : ES series, 9412
ESA, 5412 ESDD...



Padlockable wing handle

CATALOG # : 880 SCQ4-WNP
KEY NUMBER : Padlock
Key included? : No
Material : Polyamide GF/Zinc
For use with : ES series, 9412
ESA, 5412 ESDD...

ES SERIES DOOR LOCKS AND HANDLES

Industrial European styling 1/4 turn lock

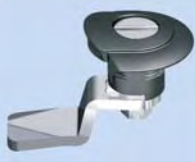

European slot lock

CATALOG # : 880 SCQ4-DSL
 KEY NUMBER : None
 Key included? : No
 Material : Polyamide GF/Zinc
 For use with : ES series, 9412
 ESA, 5412 ESDD...



European lock w/inserts

European style 1/4 turn locks are available with inserts upon request. These insert types are available :
 Square Triangular Double bit
 Hexagone Coinproof Crown
 Daimler East Europe ...

Accessories for industrial 1/4 turn locks



1/4 turn lock dust cap

CATALOG # : 880 DDC
 KEY NUMBER : None
 Key included? : No
 Material : Polyamide GF
 For use with : ES series, 9412
 ESA, 5412 ESDD...



Finger pull for 1/4 turn lock

CATALOG # : 880 DFP
 KEY NUMBER : None
 Key included? : No
 Material : Polyamide GF
 For use with : ES series, 9412
 ESA, 5412 ESDD...

Parts for quarter turn locks - Cams, inserts, housings

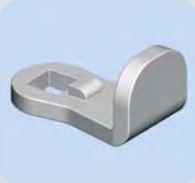

Commercial cam

CATALOG # : 880 SCQCOM-CAM
 KEY NUMBER : None
 Key included? : No
 Material : Steel
 For use with : Commercial and industrial boxes



Industrial cam ('ES' series)

CATALOG # : 880 SCQ4-CAM
 KEY NUMBER : None
 Key included? : No
 Material : Steel
 For use with : ES series, 9412
 ESA, 5412 ESDD...



Cam for 1500 CH throughs

CATALOG # : 880 SCQ4-CAMCH
 KEY NUMBER : None
 Key included? : No
 Material : Zinc Cast
 For use with : 1500 CH throughs



Industrial cam ('ESW')

CATALOG # : 880 SCQ4-CAMW
 KEY NUMBER : None
 Key included? : No
 Material : Zinc Cast
 For use with : 5412 ESW
 5412 ESSW

DESCRIPTION	CATALOG NUMBERS FOR INDIVIDUAL INSERTS AND HOUSINGS		
	CHROME PLATED ZINC CAST	STAINLESS STEEL TYPE 304	STAINLESS STEEL TYPE 316
Slot 2 X 4 mm insert	880 ISL	880 ISLSS4	880 ISLSS6
Slot 1,2 X 3 insert	880 ISL2	--	--
Square 6 mm insert	880 ISQ6	880 ISQ6SS4	--
Square 7 mm insert	880 ISQ7	880 ISQ7SS4	880 ISQ7SS6
Square 8 mm insert	880 ISQ8	880 ISQ8SS4	880 ISQ8SS6
Square 8 mm slotted	880 ISQS	--	--
Triangular 7 mm insert	880 ITR7	880 ITR7SS4	880 ITR7SS6
Triangular 8 mm insert	880 ITR8	880 ITR8SS4	880 ITR8SS6
Triangular 9 mm insert	880 ITR9	--	--
Triangular 10 mm insert	80 ITR10	--	--
Double bit 3 mm insert	880 IDB3	880 IDB3SS4	880 IDB3SS6
Double bit 5 mm insert	880 IDB5	880 IDB5SS4	880 IDB5SS6
Hexagon 10 mm insert	880 IHX	--	--
Hexagon insert with pin	880 IHXP	880 IHXPSS4	--
Slot 2 X 4 mm coinproof	880 ISLP	--	--
Crown type insert	880 ICW	--	--
Daimler Benz insert	880 IBZ	--	--
Eastern Europe Ø13	880 IEE	880 IEESS4	--
Fiat type insert	880 IFIAT	--	--
Lock housing	880 SCQH	880 SCQHSS	--

Other inserts, cams and housings available upon request. Call Eurobex at 1-800-363-2423 for more information.

Data subject to change without notice.

CABINET HANDLES

Cabinet handles

Visit
www.
eurobex
.com
for details.

Call us
toll free
1-800-363-
2423

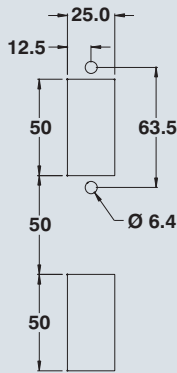

In addition to the standard slot and key lock, these inserts are available for the 885 ESL3 and 885 ESL4



Square 8mm



Square 7mm



Triangular 8mm



Triangular 7mm



Double bit 5mm



Double bit 3mm

Other inserts available upon request.



The **880 APH** automotive padlockable handle was designed to fit most type 4-12 enclosures. The handle is available with a key insert or spring loaded defeater, requiring a tool in order to operate the mechanism for disconnect requirements. A unique padlock trigger ensures positive closing. The handle can incorporate your company logo. Finish is textured black.

CATALOG NUMBER	DESCRIPTION	SHIP WGHT LBS.
880 APH-K	Key lock	2
880 APH-D	Slotted defeater	2

Note : Trigger is designed to fit 1/4" and 5/16" padlocks.



The **885 ESL3** seal type door handle was designed to fit most type 4-12 enclosures. The handle is available with a key insert, a standard slot screw driver insert or a variety of other inserts. The 885 ESL3 are used when there is a need for a swivel handle with a seal provision. A protective dust cap is provided. Locks are rated NEMA Type 4. Finish is textured black.

CATALOG NUMBER	DESCRIPTION	SHIP WGHT LBS.
885 ESL3K	Key lock	1
885 ESL3S	Screw driver slot	1
885 ESL3SQ7	Square 7mm	1
885 ESL3SQ8	Square 8mm	1
885 ESL3TR7	Triangular 7mm	1
885 ESL3TR8	Triangular 8mm	1
885 ESL3DB3	Double bit 3mm	1
885 ESL3DB5	Double bit 5mm	1
885 ESL3B	Blank	1



The **885 ESL4** seal type handle was designed to fit most type 4-12 enclosures. The handle is available with a key insert, a standard slot screw driver insert or a variety of other inserts. The 885 ESL4 are used when there is a need for a swivel handle with a padlock provision. This handle accommodates a 1/4" padlock. Locks are rated NEMA Type 4. Finish is textured black.

CATALOG NUMBER	DESCRIPTION	SHIP WGHT LBS.
885 ESL4K	Key lock	1
885 ESL4S	Screw driver slot	1
885 ESL4SQ7	Square 7mm	1
885 ESL4SQ8	Square 8mm	1
885 ESL4TR7	Triangular 7mm	1
885 ESL4TR8	Triangular 8mm	1
885 ESL4DB3	Double bit 3mm	1
885 ESL4DB5	Double bit 5mm	1
885 ESL4B	Blank	1

Data subject to change without notice.

CABINET HANDLES, PULL DOWN HASPS



The **880 PH** padlockable handles are used for outdoor application. This sturdy handle is made of chrome plated steel or of stainless steel. Comes complete with installation hardware and gasket.

CATALOG NUMBER	DESCRIPTION	SHIP WGHT LBS.
880 PH	Chrome plated steel	1
880 PHSS	Stainless steel	1



The **886 ELKPX** electronic keypad system grants access to an enclosure upon entry of the correct code on the keypad. The handle can be used standalone, in electronic master-slave systems and remote access control systems.

Please see page 66 for details.

For detailed information on the E.line electromechanical lock system, please see page 66.



The **886 ELIT** transponder handle is opened using transponder devices. The handle can be used standalone, in electronic master-slave systems and remote access control systems.

Please see page 66 for details.

For detailed information on the E.line electromechanical lock system, please see page 66.

Pull down hasps



Pull down padlock hasp

CATALOG # : 883 CM1
 KEY NUMBER : Use padlock
 Key included? : No
 Material : Plated steel
 For use with : 1300 H,
 1500 Lay-in ducts



SS Pull down padlock hasp

CATALOG # : 883 CM1SS
 KEY NUMBER : Use padlock
 Key included? : No
 Material : Stainless steel
 For use with : 5412 ESFRQ,
 1300 H, 1500 SS



SS Pull down padlock hasp

CATALOG # : 883 CM2
 KEY NUMBER : Use padlock
 Key included? : No
 Material : Stainless steel
 For use with : 5300 ES

Data subject to change without notice.

GEAR BOX AND LATCH RODS

Gear boxes - Series 885 GBOX

Visit
www.eurobex.com
for details.

Call us
toll free
1-800-363-2423

The **885 GBOX** gear boxes are used with Eurobex door locks as three point latch locking mechanisms. Three versions of 885 GBOX exist, each corresponding to a particular Eurobex door lock.



CATALOG NUMBER	FOR USE WITH	SHIP WGHT LBS.
885 GBOX1	880 PH series	1



CATALOG NUMBER	FOR USE WITH	SHIP WGHT LBS.
885 GBOX2	885 ESL2A, 880 APH	1



CATALOG NUMBER	FOR USE WITH	SHIP WGHT LBS.
885 GBOX3	885 ESL3, 885 ESL4	1

Latching rods for 5500 and 9500 series

The **CBAR series** is used as part of a three point latching mechanism in the 5412, 5500 and 9500 series enclosures. The CBAR's can be used as replacement parts or to build a custom latching mechanism.

881 CBAR latching rods fit 5500 ESDD series cabinets and large 5412 ES cabinets (height ≥ 42 ").

885 CBAR latching rods fit 5500 DDS series cabinets.

889 CBAR latching rods fit 9500 series cabinets.



CATALOG NUMBER	FOR USE WITH	SHIP WGHT LBS.
881 CBAR24	24" height	1
881 CBAR30	30" height	1
881 CBAR36	36" height	2
881 CBAR42	42" height	3
881 CBAR48	48" height	3
881 CBAR54	54" height	3
881 CBAR60	60" height	3
881 CBAR72	72" height	3



CATALOG NUMBER	FOR USE WITH	SHIP WGHT LBS.
885 CBAR60	60" height	3
885 CBAR72	72" height	3

CATALOG NUMBER	FOR USE WITH	SHIP WGHT LBS.
889 CBAR60	60" height	3
889 CBAR72	72" height	3
889 CBAR84	84" height	3
889 CBAR90	90" height	3

Data subject to change without notice.

MOUNTING FEET, FLOOR STANDS

Mounting feet for small and medium-sized enclosures



JIC Wall mounting feet
CATALOG # : 885 ESCHMF
 Four mounting feet & hardware incl.
 Mounted vertically or horizontally.
Material : Zinc cast
For use with : ESCH series,
 1100, ESSC...



'ESFR' Wall mounting feet
CATALOG # : 885 ESFRMF
 Four mounting feet & hardware incl.
 Mounted vertically or horizontally.
Material : Plastic
For use with : ESFRS, ESFRH,
 ESFRQ



'ES' Wall mounting feet
CATALOG # : 885 ESMF1
 Four mounting feet & hardware incl.
 Mounted vertically or horizontally.
Material : Plated steel
For use with : ES series, ESDD,
 5300 MC, ESA, ESY



SS Wall mounting feet
CATALOG # : 885 ESMF2
 Four mounting feet & hardware incl.
 Mounted vertically or horizontally.
Material : Stainless steel
For use with : ESS series, ESSDD
 ESSA, ESSY...



Offset mounting feet 0.5"
CATALOG # : 885 ESOMF1
 Four mounting feet & hardware incl.
 Mounted vertically or horizontally.
Material : Plated steel
For use with : ES series, ESDD,
 5300 MC, ESA, ESY



SS offset mounting feet 0.5"
CATALOG # : 885 ESOMF2
 Four mounting feet & hardware incl.
 Mounted vertically or horizontally.
Material : Stainless steel
For use with : ESS series, ESSDD
 ESSA, ESSY...



Offset mounting feet 1.5"
CATALOG # : 885 ESOMF1A
 Four mounting feet & hardware incl.
 Mounted vertically or horizontally.
Material : Plated steel
For use with : ES series, ESDD,
 5300 MC, ESA, ESY



SS offset mounting feet 1.5"
CATALOG # : 885 ESOMF2A
 Four mounting feet & hardware incl.
 Mounted vertically or horizontally.
Material : Stainless steel
For use with : ESS series, ESSDD
 ESSA, ESSY...

5412 & 5500 series floor mounting stands

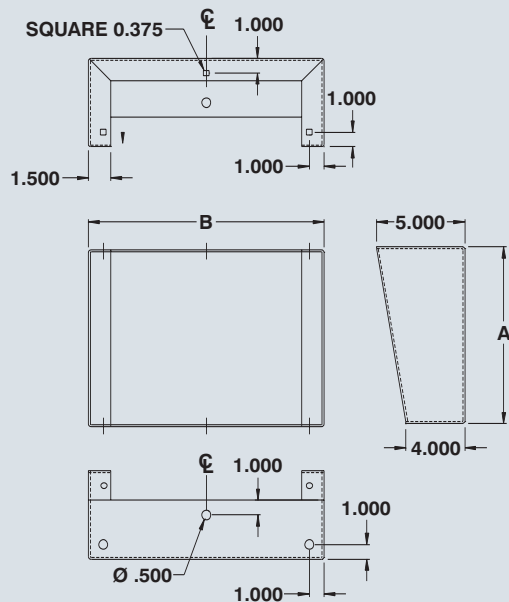

The 885 MF - Floor mounting feet are made from 14 GA steel, pre-drilled for fixation to the floor and to the bottom of the 5412 and 5500 series enclosures. Kits come complete with all necessary hardware. Mounting feet are finished with heat fused polyester powder, electrostatically applied on a phosphatized base. Finish is ANSI/ASA 61 gray.

CATALOG NUMBER	DIMENSIONS		SHIP WGT LBS.	CATALOG NUMBER	DIMENSIONS		SHIP WGT LBS.
	A	B			A	B	
885 MF0606	6	6	14	885 MF1516	15	16	37
885 MF0608	6	8	16	885 MF1520	15	20	44
885 MF0610	6	10	17	885 MF1524	15	24	45
885 MF0612	6	12	18	885 MF1806	18	6	28
885 MF0616	6	16	21	885 MF1808	18	8	32
885 MF0620	6	20	25	885 MF1810	18	10	36
885 MF0624	6	24	28	885 MF1812	18	12	41
885 MF1206	12	6	21	885 MF1816	18	16	47
885 MF1208	12	8	23	885 MF1820	18	20	49
885 MF1210	12	10	26	885 MF1824	18	24	51
885 MF1212	12	12	32	885 MF2406	24	6	38
885 MF1216	12	16	35	885 MF2408	24	8	40
885 MF1220	12	20	40	885 MF2410	24	10	45
885 MF1224	12	24	42	885 MF2412	24	12	50
885 MF1506	15	6	23	885 MF2416	24	16	58
885 MF1508	15	8	25	885 MF2420	24	20	65
885 MF1510	15	10	28	885 MF2424	24	24	70
885 MF1512	15	12	34				

* Add suffix 'SS' for stainless.

Data subject to change without notice.