

*Here's a plug that will give you a*  
*real connection* — **PLUG CAPS and**  
**CORD CONNECTORS FROM ERICSON**



The originator  
of  
**BACK-WIRED**  
plug caps and  
cord connectors

**THE ERICSON MANUFACTURING COMPANY**

1660 Hayden Avenue, Cleveland, Ohio 44112 • (216) 451-2030

**Original 1950's Advertisement**



**24/7 Emergency Assistance Hotline**  
**1-877-OSCAR99 (672-2799)**

## Ericson Manufacturing Company offers a wide variety of plugs and connectors to fit your needs.

### PERMA-LINK®



- Two-screw cable clamp secures cord and provides superior strain-relief
- Withstand high impact, corrosion, oils, greases, solvents and other chemicals across -20 °C to + 100°C
- Individual wire pockets help prevent flashovers
- Rubberized outer housing for superior grip and impact resistance
- Flexibility of reverse-cover design creates weather-resistant connections by interchanging covers
- Internal cord seals keep out water/mud/dust
- Available in all black

### PERMA-GRIP™



- Quick field assembly with cord grip nut
- Superior water/mud/dust resistance provided by safety compression cord grips
- Withstand high impact, corrosion, oils, greases, solvents and other chemicals across -20 °C to + 100°C
- Flexibility of reverse-cover design (straight blade devices) creates weather-resistant connections by interchanging covers
- Custom marking available on cord grip nut
- Available in all black

### PERMA-TITE® 2



- Tongue & groove sealing system provides extreme environmental protection of:
  - NEMA Type 4, 4X, 6, 6P & IP67
- Devices resist high-pressure hose down of 1,500 psi.
- Withstand high impact, corrosion, oils, greases, solvents and other chemicals across -20 °C to + 100°C
- Removable/replaceable self-retained sealing cap provided with connector to keep out contaminants when not in use (plug cap also available)
- Custom marking available on cord grip nut
- Available in all black

### 50 Amp Devices



- Rugged nylon construction resists impact, corrosion and jobsite oils/chemicals
- Quick field assembly, with color coded markings
- Nickel plated blades and stainless steel screws provide optimum corrosion resistance
- Boots can be threaded together with the optional sealing collar system to provide maximum environmental protection
- Available in plugs, connectors, inlets and receptacles
- Rubberized grey "Twist-Grip" for ease of connection

### Commercial Grade



- Translucent body allows device to glow from power on lamp (EL Models)
- Wide open "suitcase" style construction makes wiring easy
- Fits 10/3 to 18/3 cord diameters
- Rugged design withstands abuse on the jobsite
- Color coded termination screws for ground, hot and neutral
- Combo screw heads speed up installation
- Rubberized "grip" cushions and surrounds device
- Economy priced

## Smart Monitor



**NEW!**

### Features of All Smart Monitor Plugs & Connectors:

- Super bright 2-color LED technology
- Smart Monitor Module
- Easy to wire
- Clear internal wiring cover
- Multiple cord grommets included
- Makes OSHA safety compliance easy and cost effective

### 24/7 Monitoring of These 7 Events

- No Ground
- Loss of Ground In Cord
- Hot/Neutral Swap
- Reverse Polarity
- Hot on Ground
- Open Neutral

### 3 Styles to Pick From:

- Perma-Link®
- Perma-Grip™
- Perma-Tite® 2

## Smart Cords



**NEW!**

New From Ericson... Industrial application SmartCords factory built to last and last. Models with Smart Connector (Economy Safe) and both Smart Plug and connector are available. 24/7 monitoring with Assured Grounding Compliance to NEC and OSHA standards. Built with the highest quality materials to withstand your environment.

**NEW!**

## FS Series Single Receptacles & Male Inlets Under All Weather Flip Covers



- Weather resistant boot seals around Ericson Perma-Tite plug to provide weather resistant protection
- Spring-loaded flip-lid covers receptacle when not in use
- Includes cover plate, rubber boot, stainless steel mounting plate/mounting screws
- Impact, chemical & corrosion resistant construction stands up to demanding environments
- Mounts easily to 6200 or 6300 series FS/FD boxes and any flat surface
- Collar plug seals and grips all types of round plugs or connectors

## Double Outlet Receptacle with Cover Plates - PWDX Series

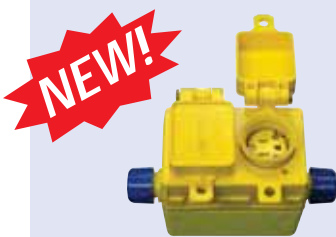

**NEW!**

- Weather resistant boot seals around Ericson Perma-Tite plug to provide weather resistant protection
- Spring-loaded flip-lid covers the receptacle when not in use
- Two independent fully rated receptacles in one easy to install assembly
- Impact, chemical & corrosion resistant construction stands up to demanding environments
- Mounts easily to 6200 series FS/FD boxes and any flat surface

## Adapters



### NEMA Change Adapters

Now make quick, secure connections between straight-blade and locking plugs and connectors with Ericson's NEMA configuration adapters.

- Heavy-duty non-conducting housing and using heavy gauge solid brass blades
- Compact size makes them easy to use and transport
- Available in molded style or short cords







# Ericson NEMA Chart

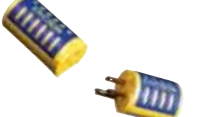

Face View	NEMA	Electrical Ratings		PERMA-TITE® 2		PERMA-GRIP™	
	Configuration	Amps	Volts	Plugs	Connectors	Plugs	Connectors
<b>2-pole, 3-Wire Grounding</b>							
	5-15	15	125	1510-PW6P	1610-CW6P	1510-PG	1610-CG
	5-20	20	125	1512-PW6P	1612-CW6P	1512-PG	1612-CG
	6-15	15	250	1514-PW6P	1614-CW6P	1514-PG	1614-CG
	6-20	20	250	1516-PW6P	1616-CW6P	1516-PG	1616-CG
	L5-15	15	125	1520-PW6P	1620-CW6P	1520-PG	1620-CG
	L6-15	15	250	1522-PW6P	1622-CW6P	1522-PG	1622-CG
	L7-15	15	277	1524-PW6P	1624-CW6P	1524-PG	1624-CG
	L5-20	20	125	2310-PW6P	2410-CW6P	2310-PG	2410-CG
	L6-20	20	250	2312-PW6P	2412-CW6P	2312-PG	2412-CG
	L7-20	20	277	2314-PW6P	2414-CW6P	2314-PG	2414-CG
<b>3-Pole, 3-Wire Non-Grounding</b>							
	Non-NEMA	20	125/250	2316-PW6P	2416-CW6P	2316-PG	2416-CG
	Non-NEMA	20/10	205/600	2317-PW6P	2417-CW6P	2317-PG	2417-GC
	Non-NEMA	15A/10A	125V/250V	1507-PW6P	1607-CW6P	1507-PG	1607-CG
<b>3-Pole, 4-Wire Grounding</b>							
	L14-20	20	125/250	2320-PW6P	2420-CW6P		
	L15-20	20	250, 3Ø	2322-PW6P	2422-CW6P		
	L16-20	20	480, 3Ø	2324-PW6P	2424-CW6P		
<b>2-Pole, 3-Wire Grounding</b>							
	L5-30	30	125	2510-PW6P	2610-CW6P	2510-PG	2610-CG
	L6-30	30	250	2512-PW6P	2612-CW6P	2512-PG	2612-GC
	L7-30	30	277	2514-PW6P	2614-CW6P	2514-PG	2614-CG
<b>3-Pole, 3-Wire Non-Grounding</b>							
	Non-NEMA	30	125/250	2516-PW6P	2616-CW6P		
<b>3-Pole, 4-Wire Grounding</b>							
	L14-30	30	125/250 3Ø	2520-PW6P	2620-CW6P		
	L15-30	30	250, 3Ø	2522-PW6P	2622-CW6P		
	L16-30	30	480, 3Ø	2524-PW6P	2624-CW6P		
	L17-30	30	600, 3Ø	2526-PW6P	2626-CW6P		
<b>4-Pole, 4-Wire</b>							
	L18-30	30	120/208 3Ø wye	2530-PW6P	2630-CW6P		
<b>4-Pole, 4-Wire Non-Grounding</b>							
	Non-NEMA	30	120/208 3Ø wye	2528-PW6P	2628-CW6P		

WIRING DEVICES

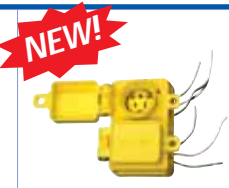
# NEMA Chart

	 <b>BETTER</b>		 <b>GOOD</b>		 <b>SMART</b>				
	PERMA-LINK®		Economy Grade*		Smart Monitor*		Single Outlet	Male Inlets	Dual Recept (PWDX)
Face View	Plugs	Connectors	Plugs	Connectors	Plugs	Connectors	FS Cover Plates		Receptacle with Cover
<b>2-pole, 3-Wire Grounding</b>									
	1510-P	1610-C	5266-E	5269-E	1510-PXX	1610-CXX	2715-FS10	2705-15/A	1610-PWDX
	1512-P	1612-C			1512-PXX	1612-CXX	2715-FS12	2705-20/A	1612-PWDX
	1514-P	1614-C	<b>Note:</b> Lighted power-on glow models also: 5266-EL & 5269-EL				2715-FS14		1614-PWDX
	1516-P	1616-C					2715-FS16		1616-PWDX
	1520-P	1620-C					2715-FS20	2705-L15/A	1620-PWDX
	1522-P	1622-C					2715-FS22		1622-PWDX
	1524-P	1624-C					2715-FS24		1624-PWDX
	2310-P	2410-C			2310-PXX	2410-CXX	2820-FS10	2705-L20	<b>6200 Series Boxes For FS Series &amp; PWDX Series</b> <ul style="list-style-type: none"> <li>• Rubberized</li> <li>• Fully Enclosed</li> <li>• Single and Double Sided</li> <li>• Standard and Deep</li> </ul> 
	2312-P	2412-C					2820-FS12		
	2314-P	2414-C					2820-FS14		
<b>3-Pole, 3-Wire Non-Grounding</b>									
	2316-P	2416-C					2820-FS16		
	2317-P	2417-C					2820-FS17		
	1507-P	1607-C					2715-FS07		
<b>3-Pole, 4-Wire Grounding</b>									
	2320-P	2420-C					2920-FS20	2705-L142	
	2322-P	2422-C					2920-FS22		
	2324-P	2424-C					2920-FS24	2705-L162	
<b>2-Pole, 3-Wire Grounding</b>									
	2510-P	2610-C					2830-FS10	2705-L30	
	2512-P	2612-C					2830-FS12		
	2514-P	2614-C					2830-FS14		
<b>3-Pole, 3-Wire Non-Grounding</b>									
	2516-P	2616-C					2830-FS16		
<b>3-Pole, 4-Wire Grounding</b>									
	2520-P	2620-C					2930-FS20	2705-L143	
	2522-P	2622-C					2930-FS22		
	2524-P	2624-C					2930-FS24	2705-L163	
	2526-P	2626-C					2930-FS26	2705-L173	
<b>4-Pole, 4-Wire</b>									
	2530-P	2630-C					2930-FS30		
<b>4-Pole, 4-Wire Non-Grounding</b>									
	2528-P	2628-C					2930-FS28		

↑

**\*Part Number Note for Smart Monitors:**

**PLUGS (-PXX)**

**PML**  
Perma-Link® Style

**PMGL**  
Perma-Grip™ Style

**PW6PL**  
Perma-Tite®2 Style

**CONNECTORS (-CXX)**

**CML**  
Perma-Link® Style

**CMGL**  
Perma-Grip™ Style

**CW6PL**  
Perma-Tite®2 Style



**Yes we can.** Ericson can customize our offering of wiring devices to meet your individual needs. The custom solution can be as simple as the popular printing on the back of the cord grip nut to fully custom colored and labeled product. Minimum order sizes will apply and well as some setup fees. Contact us to discuss your needs and custom design details.

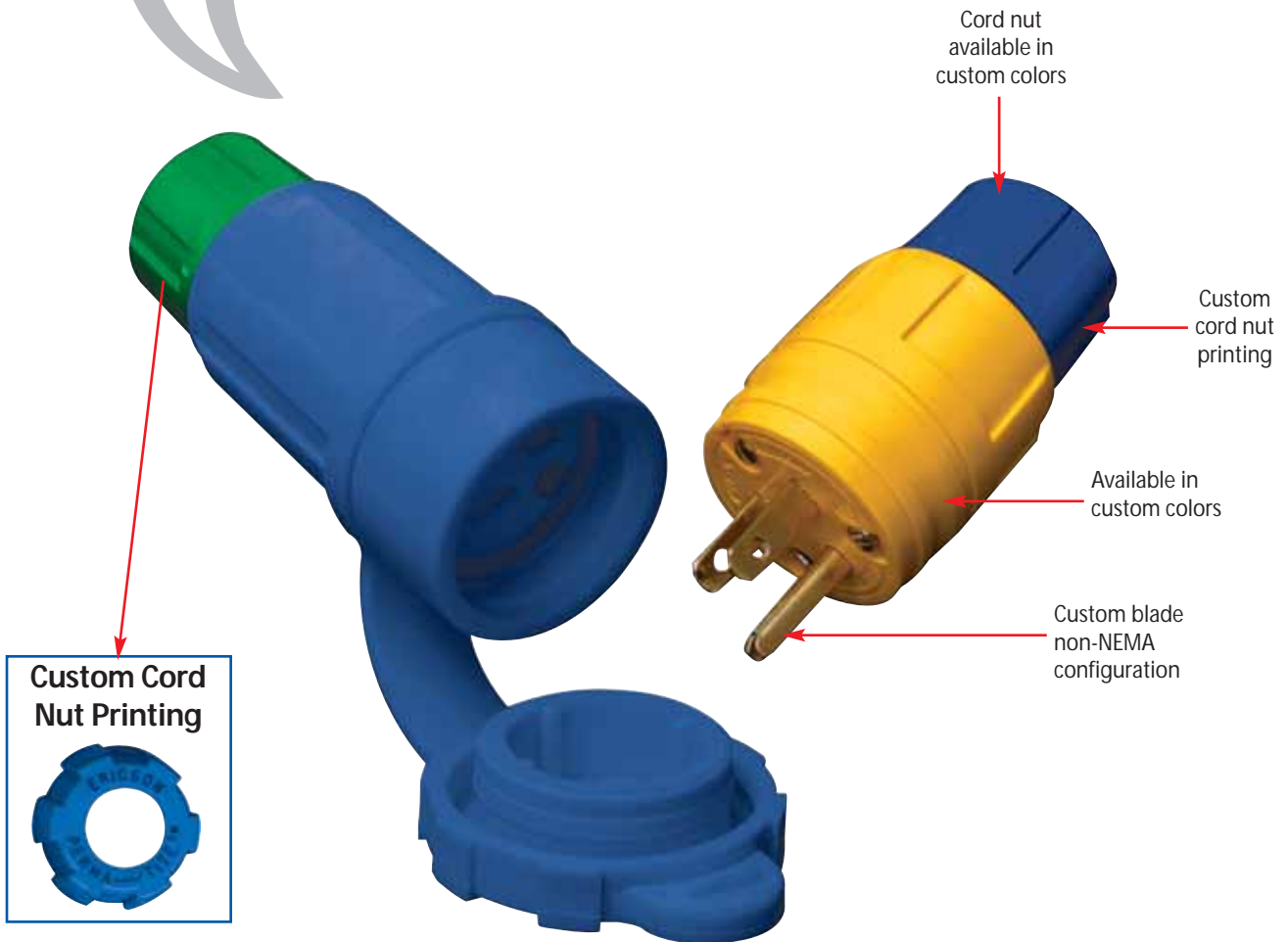

**Notes:**

1. Some customization can void certain agency safety listings or warranty.
2. Minimum quantities will apply. Other design and tooling fees may apply.

**How to order:** Contact you local Ericson Factory Representative or call us at 1-800-Ericson (374-2766)

## Commercial Grade Plugs & Connectors

The Ericson 5266 and 5269 Series of Commercial Grade plugs offer the latest in design innovation and quality in an economy grade wiring device. The demands of today's electrical industry are met with this new design with features never before seen in a commercial device. Designed to provide years of trouble free service in demanding industrial, construction and rental environments. Available in 2 styles, with and without the power on "glow" module to light up the entire device.

- 2 styles – with and without internal lamp module (see chart)
- Translucent body allows device to glow from power on lamp
- Tough, soft feel, rubber overmold grip
- Wide open "suitcase" style construction makes wiring easy
- Two captive screw body clamp design is easy to assemble
- Cord diameter matching inserts fit a wide range of cord sizes
- Solid brass blades for optimum electrical contact
- Fits 10/3 to 18/3 cord diameters\*
- Rugged design withstands abuse on the jobsite
- Clear internal conductor cover allows visual inspection
- Color coded termination screws for ground, hot and neutral
- Combo screw head

**Exclusive!** Tough, soft feel, rubber overmold grip

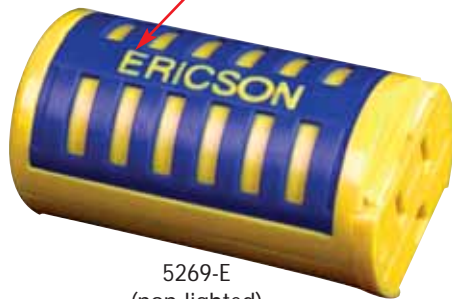

Tough nylon translucent body allows glow module to illuminate entire device<sup>1</sup>

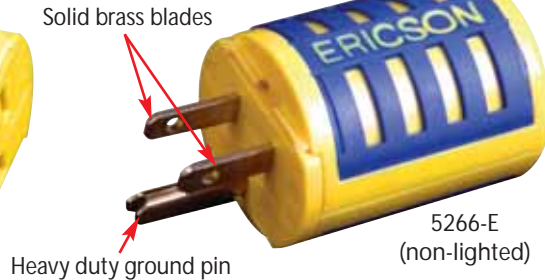

5266-EL Lighted



### 1 Piece Design - EZ To Wire

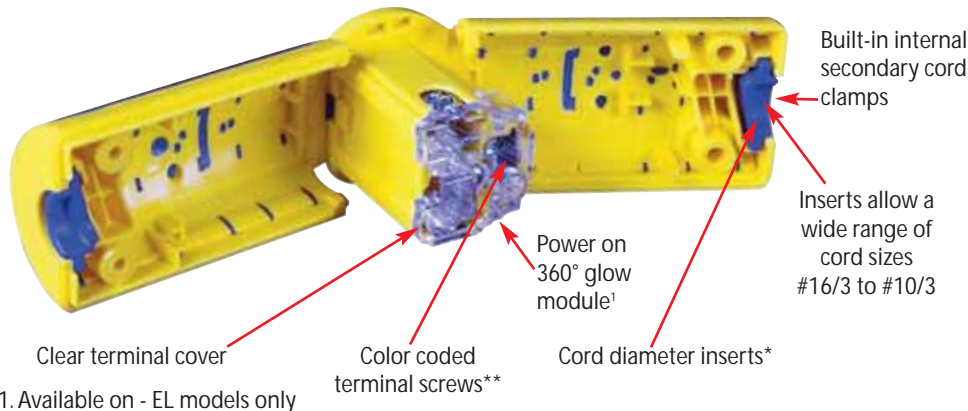

**EL Models Translucent Body "Glow"**

## Devices Selection Guide

Face View	NEMA Configuration	Electrical Ratings		With Internal Glow Light		Without Internal Glow Light	
		Amps	Volts	Plugs	Connectors	Plugs	Connectors
<b>Straight Blade, 2-pole, 3-wire Grounding Devices</b>							
	5-15	15	125				
				5266-EL	5269-EL	5266-E	5269-E

Notes:  
\*Cord diameters - .3 to .6 inch  
\*\*Slot - Phillips



## PERMA-LINK® Plugs and Connectors

United States patent number 4,021,092 was assigned to today's Perma-Link® plugs and connectors which are classified among the most rugged and safest wiring devices available. They incorporate many of the same features as Ericson Perma-Tite® 2 and Perma-Grip™ devices and utilize a two-screw cable clamp. Perma-Link® plugs and connectors are designed to provide many years of trouble-free service in the most demanding industrial and construction environments.



- UL Listed and CSA Certified
- Two-screw cable clamp secures wire and provides strain-relief
- Solid brass blades for optimum electrical and mechanical performance
- Keyed body and cover for easy alignment/assembly
- Molded-in non-slip finger-grips makes devices easy to assemble and handle
- Withstand high impact, corrosion, oils, greases, solvents and other chemicals across -20 °C to 100 °C
- Individual wire pockets help prevent flashovers
- Transparent back plate speeds wiring inspection
- Selected models available with Ground Continuity Monitor
- Available individually or on factory assembled cord sets
- Flexibility of reverse-cover design creates weather-resistant connections by interchanging covers
- Ericson's exclusive Brilliant Blue and Radiant Yellow High Visibility Dual Color Safety System

All Black Available

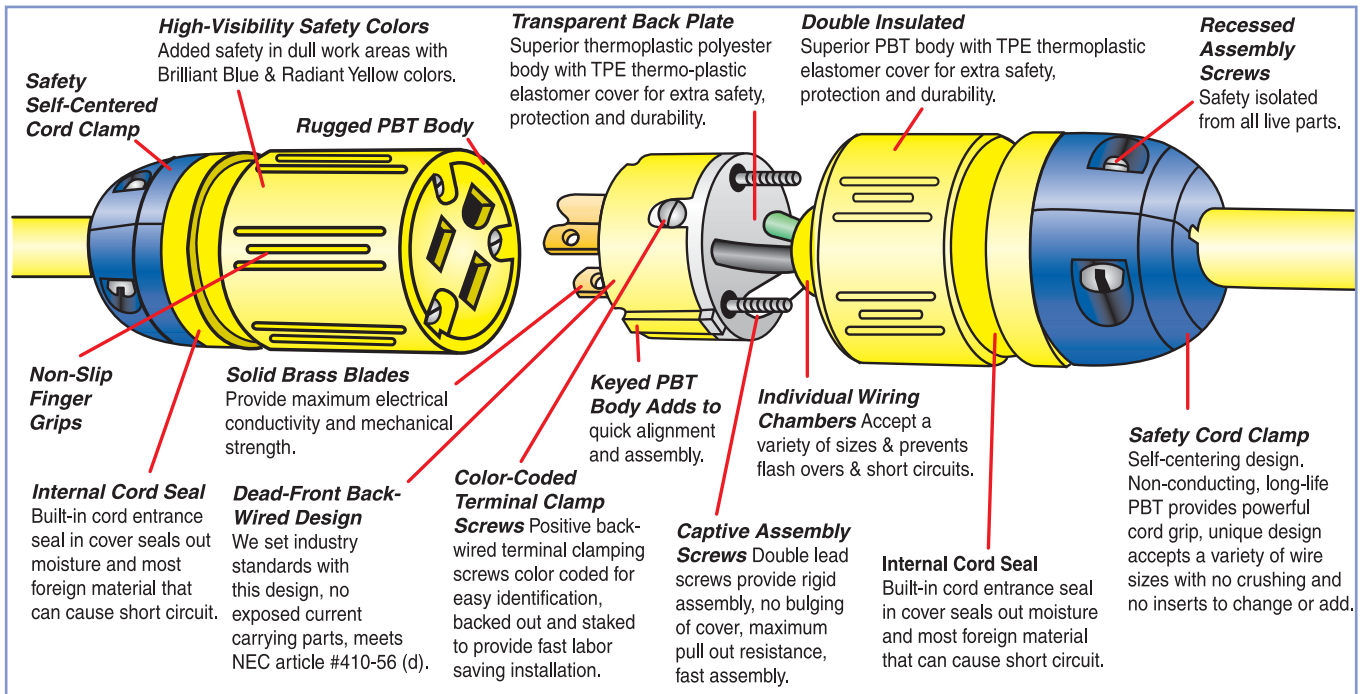
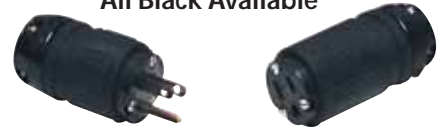

Note: Add - BLK for all black as available.

## Versatile Weather-Resistant Field Conversion

Our Perma-Link® plugs and connectors (straight blade only) are designed so they can easily be converted to create weather-resistant connections by interchanging the internal assemblies. Insert the plug body into the connector cover, and the connector body into the plug cover. There are no extra parts to purchase.

### Step 1:

Disassemble The Plug & Connector As Shown

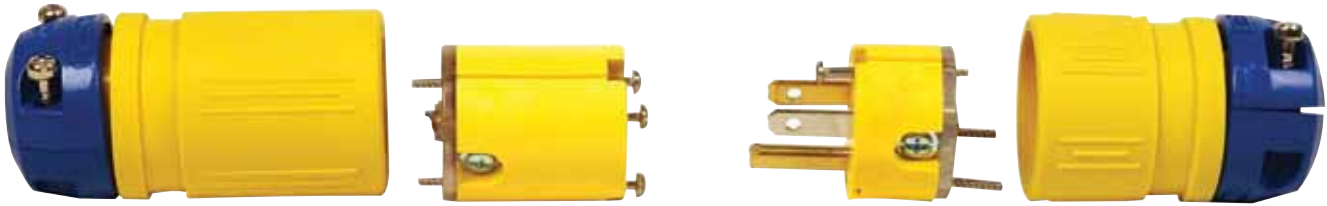

### Step 2:

Swap Plug & Connector Assemblies

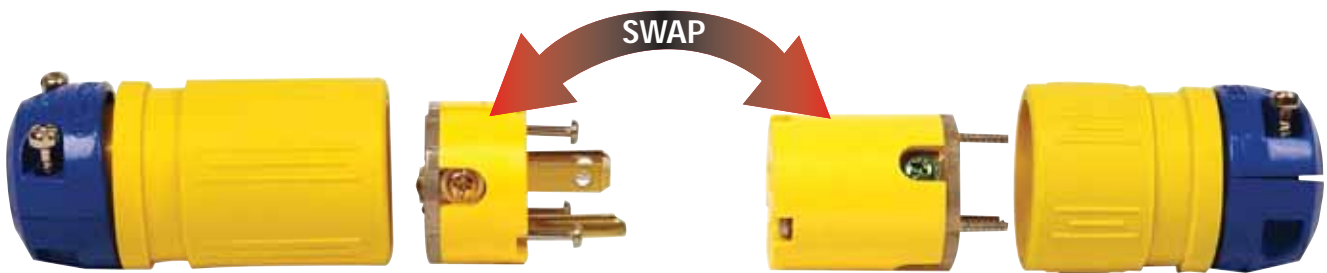

### Step 3:

Assemble Cords Per Bag Instructions

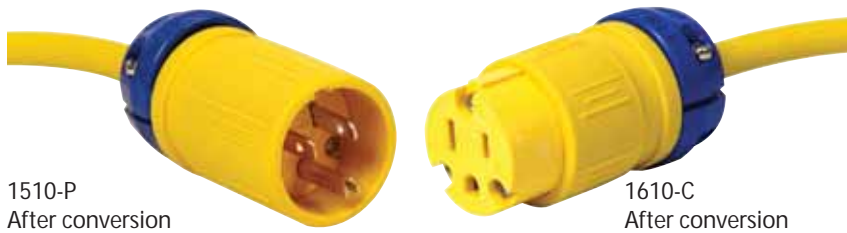

Now Your Perma-Link® Plugs & Connectors  
Are More Weather Resistant!



**ERICSON EXCLUSIVE**

**PERMA-GRIP™ Plugs and Connectors**

Ericson's industry exclusive design combines the Perma-Tite® cord grip with the industry proven design of its Perma-Link® devices to provide a line of **incredibly tough plugs and connectors** that stand up to the most demanding industrial and construction environments.



- UL Listed and CSA Certified, some ETL Listed
- Quick field assembly, no cable clamp screws to tighten, simply twist on the cord grip nut
- Water/mud/dust resistance provided by safety compression cord grips
- Keyed body and cover for easy alignment/assembly
- Color coded rubber cord-seal bushings accommodate a wide range of cable diameters
- Molded-in non-slip fingers grips makes devices easy to assemble and handle
- Withstand high impact, corrosion, oils, greases, solvents and other chemicals across -20 °C - +65 °C
- Nickel plated brass blades and ground pin stops corrosion and keeps solid electrical contact

- Individual wire pockets help prevent flashovers
- Transparent back plate speeds wiring inspection
- Selected models available with Ground Continuity Monitor
- Available individually or on factory assembled cord sets
- Flexibility of reverse-cover design (straight blade devices) creates weather-resistant connections by interchanging covers
- Ericson's exclusive Brilliant Blue and Radiant Yellow High Visibility Dual Color Safety System



All Black Available



Complete Kit as Shown

**FEATURE**

**Safety Compression Cord Grip**  
Non-conductive, long life rugged PBT, powerful cord grip, unique design accepts all AWG wire range sizes from #18 through #12 with no crushing and no inserts to change or add

**High-Visibility Safety Colors**  
Added safety in dull work areas With Brilliant Blue and Radiant Yellow colors.

**Transparent Back Plate**  
Clear polycarbonate permits visual wiring inspection without disassembly

**Keyed PBT Body**  
Adds to quick alignment and assembly.

**Double Insulated**  
Superior PBT body with TPE thermoplastic elastomer cover for extra safety, protection and durability.

**FEATURE! Internal Cord Seal**  
Built-in cord entrance seal in cover seals out moisture and most foreign material that can cause short circuit.

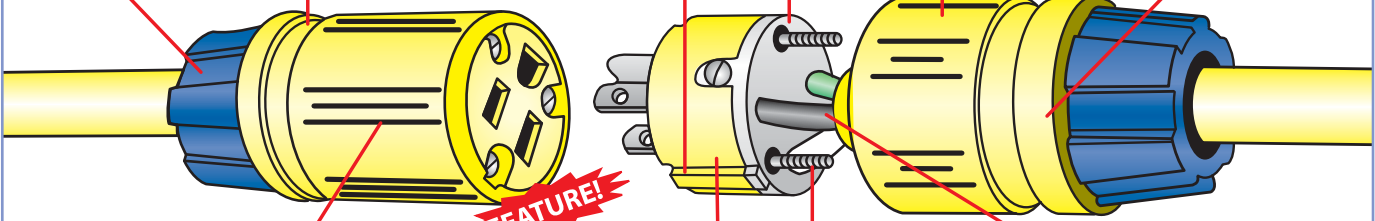

**Non-Slip Finger Grips**

**FEATURE!**

Blades nickel plated to prevent corrosion

**Captive Assembly Screws**  
Double lead screws provide rigid assembly, no bulging of cover, maximum pull out resistance, fast assembly.

**Individual Wire Chambers**  
Accepts up to #12 AWG conductors and prevents flash overs and short circuits.

**EXTRA GROMMETS** Color coded rubber cord sealer grommets supplied for a variety of diameters.



**Dead-Front Back-Wired Design**  
We set industry standards with this design, no exposed current carrying parts, meets NEC article #410-56 (d).

Note: Add - BLK for all black as available.

## PERMA-TITE® 2 Plugs and Connectors

Perma-Tite®2 plugs and connectors are engineered and manufactured to the highest quality standards to provide the ultimate in electrical service and protection. They are designed and proven to do their best under the worst conditions in a broad array of the most severe food processing, industrial, marine, construction and petro-chemical work environments.

- UL Listed & CSA Certified, some ETL Listed
- Tongue & groove sealing system provides environmental protection of:
  - NEMA Type 4, 4X, 6, 6P & IP67
- Devices resist high-pressure hose down of 1,500 psi.
- Plug & Connector bodies made with PBT chosen for its high resistance to moisture absorption, high voltage arcing and carbon tracking
- Keyed body and cover for easy alignment/assembly
- Color coded sealing bushings are provided to fit a variety of cord diameters
- Removable/replaceable self-retained sealing cap provided with connector to keep out contaminants when not in use
- Nickel plated blades for corrosion resistance
- Transparent back-plate makes for quick visual wiring checks
- Ericson's new brilliant Blue and Radiant Yellow High Visibility Dual Color Safety System symbolizes that legendary Ericson Quality



All Black Available

**NEMA TYPE**  
4, 4X, 6, 6P & IP67

- Excels in demanding outdoor & in-plant environments
- Resists hose directed water, the entry of water during prolonged submersion at a limited depth & damage from external ice formation

### Typical Applications

- Food processing
- Pulp and paper mills
- Refineries and Petro Chem Facilities
- Ship yards
- Utilities
- Marine



16CW

Connector Cover Available

15PW

Plug Cover Available

## PERMA-TITE® 2

**EXTRA GROMMETS** Color coded rubber cord sealer grommets supplied for a variety of diameters.

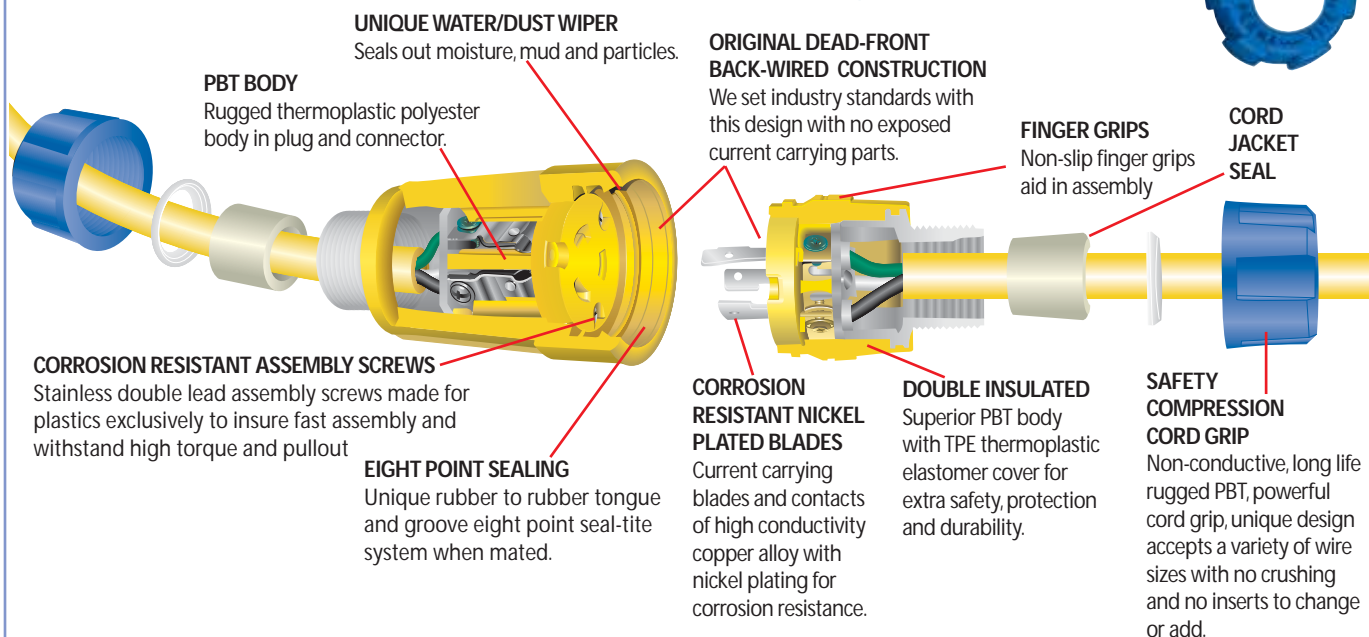

Note: Add - BLK for all black as available.



## Smart Monitor Plugs & Connectors Constantly Monitor These Conditions:

- No Ground
- Loss of Ground In Cord
- Hot/Neutral Swap
- Reverse Polarity
- Hot on Ground
- Open Neutral

### Features Of All Smart Monitor Plugs & Connectors:

- Super Bright LED Technology
- Smart Monitor Module
- Keyed body and cover
- Easy to wire
- Clear internal wiring cover
- Non-slip finger grips
- Color coded terminal screws
- Multiple cord grommets included
- Rubberized outer body
- Safety Yellow and Blue body

### ERICSON EXCLUSIVE

"LIKE HAVING A METER IN EVERY PLUG..."

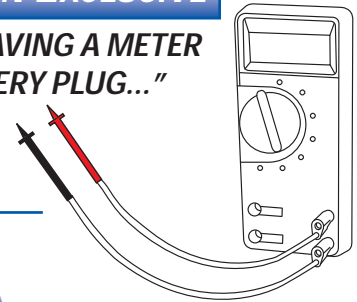

- No Ground
- Loss of Ground In Cord
- Hot/Neutral Swap
- Reverse Polarity
- Hot on Ground
- Open Neutral

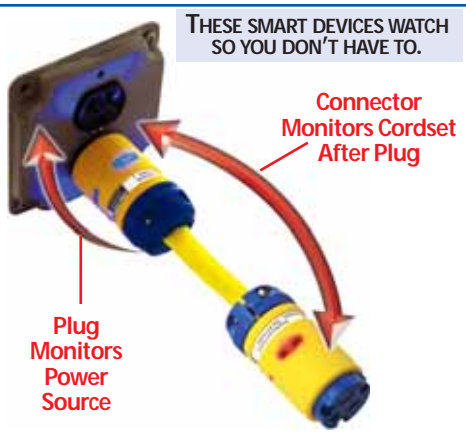

**BLUE**  
OK TO USE

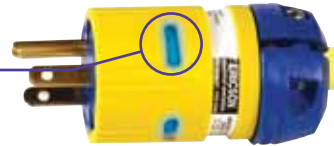

LEDs light up to let you know power is O.K.



24/7  
Monitoring



**RED**  
STOP, CALL AN  
ELECTRICIAN!

LEDs light up to let you know there is a problem

## How It Works - Diagnostic Safety Cords

### Economy Safe Cords



**Cordset is OK to Use**

- Safety earth ground is OK
- power polarity is OK

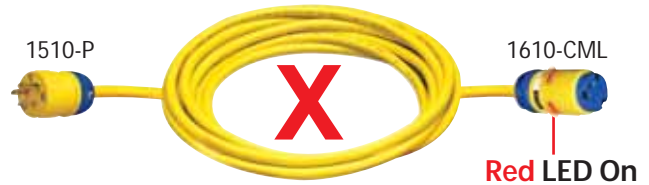

**Do Not Use**

- Check power source for proper wiring and ground
- Check cord for cuts, nicks etc.
- Check plug wiring
- Check connector wiring

### Full Diagnostic Safety Cords\*



**Do Not Use**

- Source power is OK
- Check cord for cuts, nicks etc.
- Check connector wiring



**Do Not Use**

- Check power source for wiring or missing earth ground

**Using Smart Monitor with Tool Cords**

**Blue OK to use tool\*\***

**Red STOP!**

- Check power source for wiring or missing earth ground
- Check for miswired receptacle

\* Full diagnostic safety cords give easy-to-understand indications which saves time tracking down electrical safety issues.

\*\*This device does not diagnose any tool internal issues. This device is an indication that the power and safety earth ground are present.

# Smart Monitor Series

## Cord Clamp Style



### Perma-Link™ Cord Clamp Style Features:

- Internal cord seal
- Dual screw self-centering clamp
- Rubberized outer body

XXXX-PML

## Cord Grip Style



### Perma-Grip™ Cord Grip Nut Style Features:

- Nickel plated solid brass blades
- Super sealing cord grip nut design



XXXX-PMGL

## Water Tight Style



### Perma-Tite2™ All Weather Cord Grip Nut Style features:

- All weather - NEMA 6P rated
- Super sealing rings
- Nickel plated solid brass blades
- Super sealing cord grip nut design
- Connector includes cover
- 360° indication

XXXX-CW6PL

## Plug & Connector Selection Guide

Face View	NEMA Configuration	Electrical Ratings		Perma-Link®		Perma-Grip®		Perma-Tite® 2	
		Amps	Volts	Plugs	Connectors	Plugs	Connectors	Plugs	Connectors
<b>Straight Blade, 2-pole, 3-wire Grounding Devices</b>									
	5-15	15	125	1510-PML	1610-CML	1510-PMGL	1610-CMGL	1510-PW6PL	1610-CW6PL
	5-20	20	125	1512-PML	1612-CML	1512-PMGL	1612-CMGL	1512-PW6PL	1612-CW6PL
<b>Locking, 2-pole, 3-wire Grounding</b>									
	L5-20	20	125	2310-PML	2410-CML	2310-PMGL	2410-CMGL	2310PW6PL	2410-CW6PL
	L5-15	15	125	1520-PML	1620-CML	1520-PMGL	1620-CMGL	1520-PW6PL	1620-CW6PL

**New From Ericson...** Industrial application SmartCords factory built to last and last. Models with Smart Connector (Economy Safe) and both Smart Plug and Connector are available. 24/7 monitoring with Assured Grounding Compliance to NEC and OSHA standards. Built with the highest quality materials to withstand your environment.



1510PML123A shown

### Cord

Tough 600V rated SOW cordage for long lasting wear

### Smart Monitor Connector

Checks entire cordset from the plug to the connector

## Cordset Selection Guide

Economy Safe SmartCords P/N*	Length	Non-smart PLUG	Smart Connector	Cord Size	Rating
1610XXX143	A = 25ft B= 50ft D=100ft	1510-__	1610-__L	#14/3 SOW	15A
1610XXX123		1510-__	1610-__L	#12/3 SOW	15A
1612XXX123		1510-__	1610-__L	#12/3 SOW	20A
2410XXX123		2310-__	2410-__L	#12/3 SOW	20A
Note: plug and connector type will be based on selection made of the master cordset part number - style will match					
Full Diagnostic Safety SmartCords P/N**	Length	Smart PLUG	Smart Connector	Cord Size	Rating
1510XXX143	A = 25ft B= 50ft D=100ft	1510-__L	1610-__L	#14/3 SOW	15A
1510XXX123		1510-__L	1610-__L	#12/3 SOW	15A
1512XXX123		1512-__L	1610-__L	#12/3 SOW	20A
2310XXX123		2310-__L	2410-__L	#12/3 SOW	20A
Note: plug and connector type will be based on selection made of the master cordset part number					

\* Replace XXX with: (Economy Cordsets Only)

CML = PermaLink Style Light Industrial Wiring Devices ( non-smart Plug and Smart Connector installed)

CMGL = PermaGrip Style Industrial Wiring Devices with nickel plated blades (non-smart Plug and Smart Connector installed)

CW6PL = PermaTite Style Industrial All-Weather Wiring Devices (non-smart Plug and Smart Connector installed)

\*\* Replace XXX with: (Full Diag Cordsets Only)

PML = PermaLink Style Light Industrial Wiring Devices (Smart Plug and Smart Connector installed)

PMGL = PermaGrip Style Industrial Wiring Devices with nickel plated blades (Smart Plug and Smart Connector installed)

PW6PL = PermaTite Style Industrial All-Weather Wiring Devices (Smart Plug and Smart Connector installed)



# "Crowsfoot" Devices - Non-NEMA

This Non-NEMA configuration, commonly called the "crowsfoot", is widely used in critical applications that require equipment to be plugged into a specific electrical system to ensure proper function or to prevent equipment damage.

## Typical Applications

- Low-voltage hand lamps and matching transformers
- Data acquisition/logging equipment to detect level and flow measurements on tanks and valves
- Sensitive electronic equipment that must be used on voltage regulated circuits

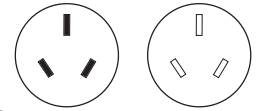

## Features Guide

- Plug and connector bodies made with PBT chosen for its high resistance to moisture absorption, high voltage arcing and carbon tracking.
- Transparent back-plate makes for quick visual wiring checks.
- Keyed body and cover for easy alignment/assembly.
- Color-coded sealing bushings are provided to fit a variety of cord diameters.
- Perma-Tite® 2 devices have the eight-point rubber tongue and groove sealing system to provide environmental protection.
- Rubber sealing cap provided with Perma-Tite® 2 connector to keep out contaminants when not in use.
- Optional plug cover available - order catalog number 15PW.
- Ericson's exclusive Brilliant Blue and Radiant Yellow High Visibility Dual Color Safety System.
- Perma-Tite® 2 devices rated NEMA 4, 4X, 6, 6P & IP67.

**PERMA-GRIP™** plug and connector with industry exclusive cord grip nut for rapid field assembly



1607-CG

1507-PG



1507-PW6P



1607-CW6P

Perma-Grip™ & Perma-Tite®2 plugs & connectors come with color coded rubber cord seal bushings for a variety of cable diameters.

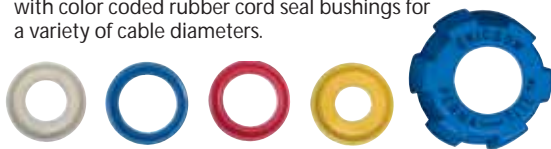

**PERMA-TITE® 2** plug and connector

Face View	NEMA Config.	Electrical Ratings		Perma-Grip™		Perma-Tite® 2	
	Non-NEMA	15A	125V	1507-PG	1607-CG	1507-PW6P	1607-CW6P
		10A	250V				



Original 1980's Advertisement





WHEN USED WITH PERMA-TITE®2 PLUG

## All Weather Heavy Duty Double Outlet Receptacle with Cover Plates - PWDX

- Weather resistant boot seals around plug to provide weather resistant protection\*
- Spring-loaded flip-lid covers receptacle when not in use
- Impact, chemical & corrosion resistant construction stands up to demanding environments
- Mounts easily to 6200 series FS/FD/FT boxes and any flat panel surface
- Also mounts to permanent FS boxes for outdoor power
- Spring loaded flip covers with SS hardware
- Lock out tabs

\* Use Ericson Perma-Tite® 2 plugs for the ultimate in weather resistance



See the Video

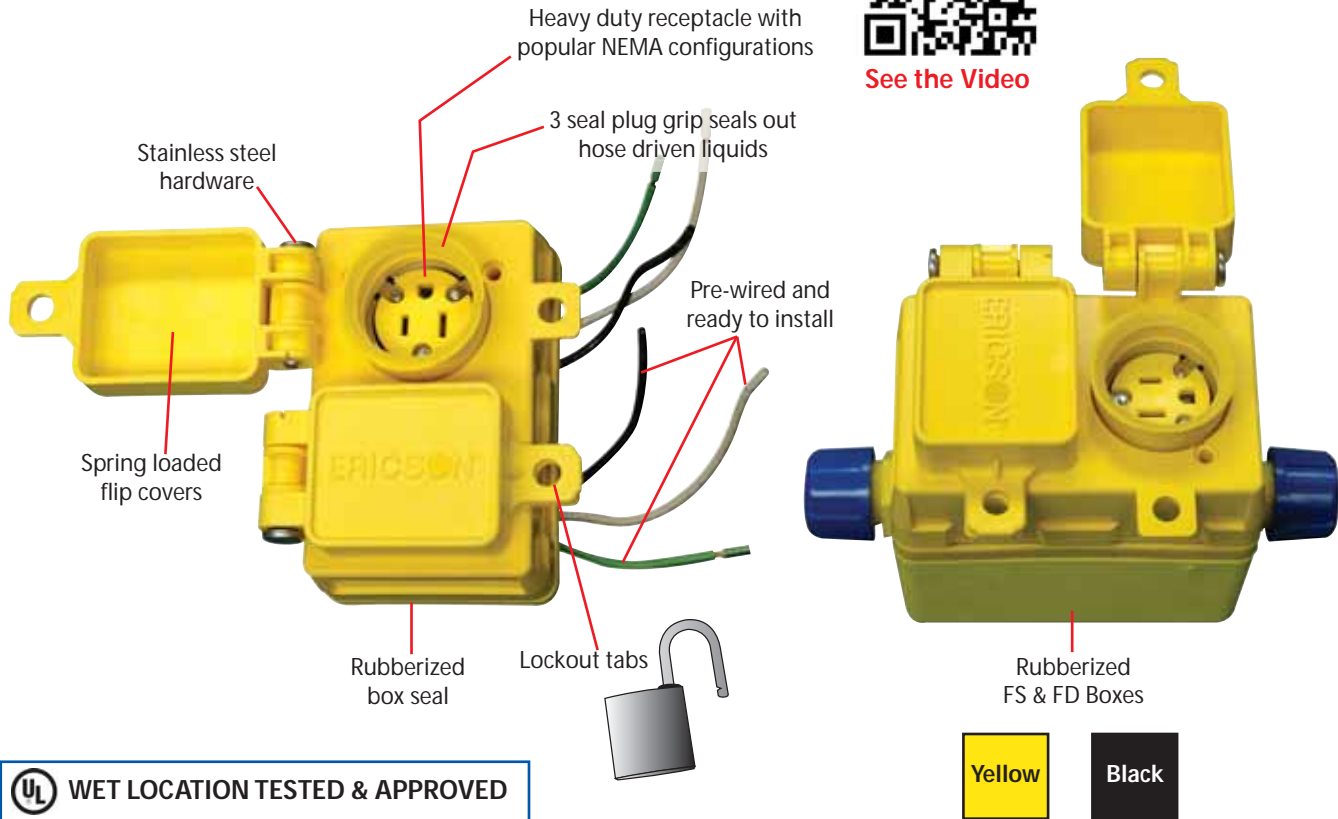

WET LOCATION TESTED & APPROVED



GREAT FOR OUTDOOR POWER!

- Features**
- All weather/heavy duty
  - Spring loaded covers
  - 3 lip built-in seal
  - Hose down
  - Heavy duty receptacles
  - Lockout/tag out

- Applications**
- Food processing
  - Pendant cord ceiling drop power
  - Wall mounted outdoor power
  - Outdoor lighting landscape power
  - Venue landscape power
  - 3 Phase cordsets
  - Convention and trade show power taps

**Mates with Ericson Perma-Tite®2 Series Plugs**

**For the Ultimate in Weather Proof Sealing**



WIRING DEVICES

# PWDX Series - Applications

The PWDX Series is designed for hanging pendant power where splash and hose-down are used. The PWDX spring-loaded flip covers are extra deep and internally sealed to guard against splash and hose directed liquids. The non-metallic design is perfect for food and liquid processing where metal and glass fragments are not acceptable. The non-metallic cord grip assembly (an Ericson Exclusive Feature), is tested to hold the PWDX assembly for years of worry free service.

- Single PWDX or Double Receptacle Assemblies
- Each connection covered with spring loaded flip cover
- SS spring and pin hinge assembly
- Great for outdoor or hose down areas
- Lockout/Tagout tabs on each receptacle
- Use wall mount kit to secure (sold separately)

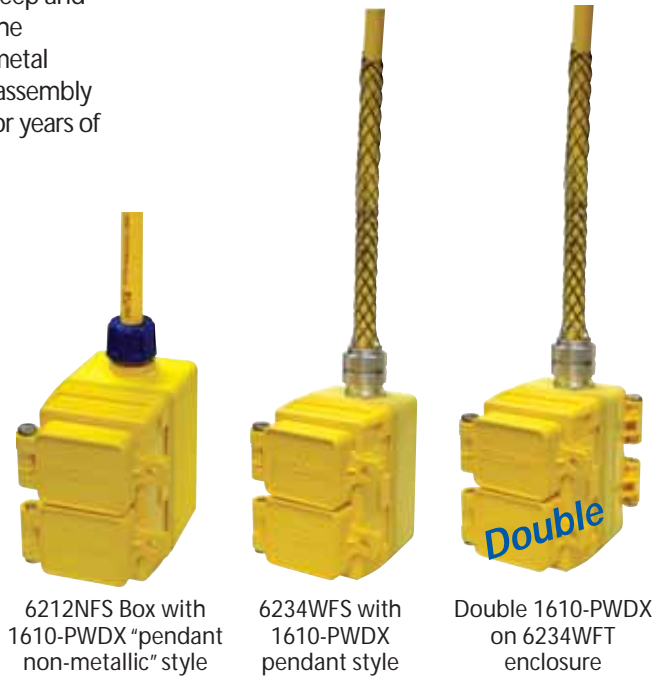

## Power "Stringer" Application

The versatile PWDX assemblies can be used to build a superior outdoor rated power distribution "stringer" cordset. Use the "feed-thru" models to link the PWDX assemblies along cord for the ultimate in outdoor sealed power drops. Mate the Ericson Brand Perma-Tite2 plugs with the PWDX to get the highest level of dust, rain, hose, spray or snow/ice protection. Great for local carnivals and fairs where compliance is mandatory and non-metallic enclosures are dangerous or not allowed\*.

- "Bathtub" enclosure design restricts water and rain entry
- Use for compliant power stringers
- Mate with Perma-Tite2 plugs for the ultimate in weather tight sealing

\*The NEC restricts the use of metallic "job" boxes for use in temporary relocateable power cords. Only use non-metallic enclosures designed and tested to meet compliance.

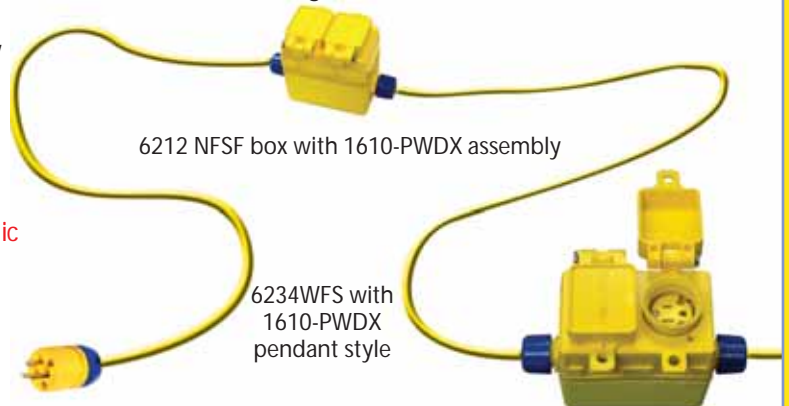





## Outdoor Landscape Power

Perfect for outdoor power taps at home, business or outdoor venues, the PWDX is designed to mate with any metallic FS box for a solid all-weather seal. Use the black versions for more discrete hiding of power taps. GFCI protection is recommended at the service panel with a GFCI circuit breaker to protect the service line, metal conduit /enclosure and PWDX receptacles.

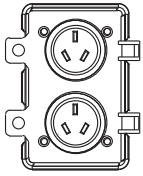
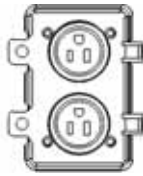
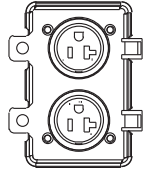
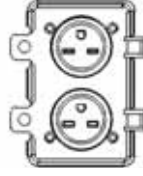
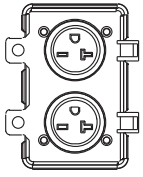
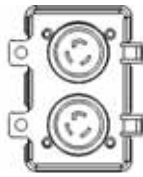
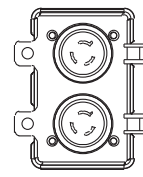
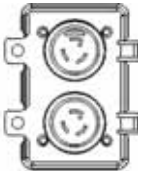
- Perfect for holiday or street lighting in cities
- Much heavier duty than standard clear rain covers
- Mates will all standard metallic FS enclosures



<b>1607-PWDX</b> 	<b>1610-PWDX</b> NEMA 5-15 	<b>1612-PWDX</b> NEMA 5-20 	<b>1614-PWDX</b> NEMA 
<b>1616-PWDX</b> NEMA 	<b>1620-PWDX</b> NEMA 	<b>1622-PWDX</b> NEMA 	<b>1624-PWDX</b> NEMA 

<b>6212FS</b> 	<b>6234FD</b> 	<b>6234FT</b> 	<b>6234WFS</b> 
<b>6212NFS</b> 	<b>6212NFD</b> 	<b>6212NFT</b> 	<b>6210WFD</b> 
<b>6234NFS</b> 	<b>6234NFD</b> 	<b>6234NFT</b> 	<b>6234WFT</b> 

<b>(NM) Non Metallic Bushing Kits</b>			<b>Wire Mesh Grips</b>	<b>Wall/Post Mount Kit 6260WK</b>
<b>82005 - 1/2"</b>	<b>82034 - 3/4"</b>	<b>82010 - 1"</b>		
 Kit			 82005W = 1/2" 82034W = 3/4" 82010W = 1"	



Part Number	Description	Color	Strain Relief	NEMA Config	Amps	Volts
<b>PWDX Dual Receptacle &amp; Cover Assembly/ Prewired</b>						
<b>Straight</b>						
1607-PWDX						
1610-PWDX	Receptacle & Flip Cover, Duplex, All Weather, 5-15	Yellow	n/a	5-15	15	125
1612-PWDX	Receptacle & Flip Cover, Duplex, All Weather, 5-20	Yellow	n/a	5-20	20	125
1614-PWDX	Receptacle & Flip Cover, Duplex, All Weather, 6-15	Yellow	n/a	6-15	15	250
1616-PWDX	Receptacle & Flip Cover, Duplex, All Weather, 6-20	Yellow	n/a	6-20	20	250
1610-PWDX-BLK	Receptacle & Flip Cover, Duplex, All Weather, 5-15, Blk	Black	n/a	5-15	15	125
1612-PWDX-BLK	Receptacle & Flip Cover, Duplex, All Weather, 5-20, Blk	Black	n/a	5-20	20	125
<b>Locking</b>						
1620-PWDX	Receptacle & Flip Cover, Duplex, All Weather, L5-15	Yellow	n/a	L5-15	15	125
1622-PWDX	Receptacle & Flip Cover, Duplex, All Weather, L6-15	Yellow	n/a	L6-15	15	250
1624-PWDX	Receptacle & Flip Cover, Duplex, All Weather, L7-15	Yellow	n/a	L7-15	15	277
<b>Boxes for PWDX - Punched - No Bushing Kit</b>						
6212FS	Box, Std Depth, PWDX, No bushing, 1/2" NPT	Yellow				
6234FS	Box, Std Depth, PWDX, No bushing, 3/4" NPT	Yellow				
6210FS	Box, Std Depth, PWDX, No bushing, 1" NPT	Yellow				
6212FD	Box, Deep, PWDX, No bushing, 1/2" NPT	Yellow				
6234FD	Box, Deep, PWDX, No bushing, 3/4" NPT	Yellow				
6210FD	Box, Deep, PWDX, No bushing, 1" NPT	Yellow				
6212FT	Box, OPEN, PWDX, No bushing, 1/2" NPT	Yellow				
6234FT	Box, OPEN, PWDX, No bushing, 3/4" NPT	Yellow				
6210FT	Box, OPEN, PWDX, No bushing, 1" NPT	Yellow				
6212FSF	Box, Std Depth, PWDX, No Bushing, Feed thru, 1/2" NPT	Yellow				
6234FSF	Box, Std Depth, PWDX, No Bushing, Feed thru, 3/4" NPT	Yellow				
6210FSF	Box, Std Depth, PWDX, No Bushing, Feed thru, 1" NPT	Yellow				
6212FDF	Box, Deep, PWDX, No Bushing, Feed thru, 1/2" NPT	Yellow				
6234FDF	Box, Deep, PWDX, No Bushing, Feed thru, 3/4" NPT	Yellow				
6210FDF	Box, Deep, PWDX, No Bushing, Feed thru, 1" NPT	Yellow				
6212FTF	Box, OPEN, PWDX, No Bushing, Feed thru, 1/2" NPT	Yellow				
6234FTF	Box, OPEN, PWDX, No Bushing, Feed thru, 3/4" NPT	Yellow				
6210FTF	Box, OPEN, PWDX, No Bushing, Feed thru, 1" NPT	Yellow				
<b>ALL BLACK - add -BLK to part number for all black</b>						
<b>Boxes for PWDX - 1/2" NPT Bushing Installed (N = Non Metallic W = Wire Mesh)</b>						
6212NFS	Box, Std Depth, PWDX, NM Bushing, 1/2" NPT	Yellow				
6212NFD	Box, Deep, PWDX, NM Bushing, 1/2" NPT	Yellow				
6212NFT	Box, OPEN, PWDX, NM Bushing, 1/2" NPT	Yellow				
6212NFSF	Box, Std Depth, PWDX, NM Bushing, Feed thru, 1/2" NPT	Yellow				
6212NFDF	Box, Deep, PWDX, NM Bushing, Feed thru, 1/2" NPT	Yellow				
6212NFTF	Box, OPEN, PWDX, NM Bushing, Feed thru, 1/2" NPT	Yellow				
6212WFS	Box, Std Depth, PWDX, WireMesh Bushing, 1/2" NPT	Yellow				
6212WFD	Box, Deep, PWDX, WireMesh Bushing, 1/2" NPT	Yellow				
6212WFT	Box, OPEN, PWDX, WireMesh Bushing, 1/2" NPT	Yellow				
6212WFSF	Box, Std Depth, PWDX, WireMesh Bushing, Feed thru, 1/2" NPT	Yellow				
6212WFDF	Box, Deep, PWDX, WireMesh Bushing, Feed thru, 1/2" NPT	Yellow				
6212WFTF	Box, OPEN, PWDX, WireMesh Bushing, Feed thru, 1/2" NPT	Yellow				
<b>ALL BLACK - add -BLK to part number for all black</b>						
<b>Boxes for PWDX - 3/4" NPT Bushing Installed (N = Non Metallic W = Wire Mesh)</b>						
6234NFS	Box, Std Depth, PWDX, NM Bushing, 3/4" NPT	Yellow				
6234NFD	Box, Deep, PWDX, NM Bushing, 3/4" NPT	Yellow				
6234NFT	Box, OPEN, PWDX, NM Bushing, 3/4" NPT	Yellow				
6234NFSF	Box, Std Depth, PWDX, NM Bushing, Feed thru, 3/4" NPT	Yellow				
6234NFDF	Box, Deep, PWDX, NM Bushing, Feed thru, 3/4" NPT	Yellow				
6234NFTF	Box, OPEN, PWDX, NM Bushing, Feed thru, 3/4" NPT	Yellow				
6234WFS	Box, Std Depth, PWDX, WireMesh Bushing, 3/4" NPT	Yellow				
6234WFD	Box, Deep, PWDX, WireMesh Bushing, 3/4" NPT	Yellow				
6234WFT	Box, OPEN, PWDX, WireMesh Bushing, 3/4" NPT	Yellow				
6234WFSF	Box, Std Depth, PWDX, WireMesh Bushing, Feed thru, 3/4" NPT	Yellow				
6234WFDF	Box, Deep, PWDX, WireMesh Bushing, Feed thru, 3/4" NPT	Yellow				
6234WFTF	Box, OPEN, PWDX, WireMesh Bushing, Feed thru, 3/4" NPT	Yellow				
<b>ALL BLACK - add -BLK to part number for all black</b>						
<b>Boxes for PWDX - 1" NPT Bushing Installed (N = Non Metallic W = Wire Mesh)</b>						
6210NFS	Box, Std Depth, PWDX, NM Bushing, 1" NPT	Yellow				
6210NFD	Box, Deep, PWDX, NM Bushing, 1" NPT	Yellow				
6210NFT	Box, OPEN, PWDX, NM Bushing, 1" NPT	Yellow				
6210NFSF	Box, Std Depth, PWDX, NM Bushing, Feed thru, 1" NPT	Yellow				
6210NFDF	Box, Deep, PWDX, NM Bushing, Feed thru, 1" NPT	Yellow				
6210NFTF	Box, OPEN, PWDX, NM Bushing, Feed thru, 1" NPT	Yellow				
6210WFS	Box, Std Depth, PWDX, WireMesh Bushing, 1" NPT	Yellow				
6210WFD	Box, Deep, PWDX, WireMesh Bushing, 1" NPT	Yellow				
6210WFT	Box, OPEN, PWDX, WireMesh Bushing, 1" NPT	Yellow				
6210WFSF	Box, Std Depth, PWDX, WireMesh Bushing, Feed thru, 1" NPT	Yellow				
6210WFDF	Box, Deep, PWDX, WireMesh Bushing, Feed thru, 1" NPT	Yellow				
6210WFTF	Box, OPEN, PWDX, WireMesh Bushing, Feed thru, 1" NPT	Yellow				
<b>ALL BLACK - add -BLK to part number for all black</b>						

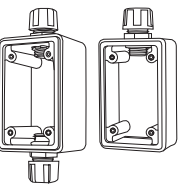
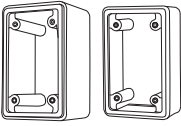
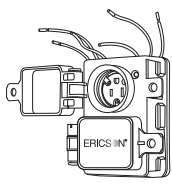

## PERMA-TITE®2 Single Outlet Receptacle with Cover Plates - FS Series

- Weather resistant boot seals around Ericson Perma-Tite plug to provide weather resistant protection
- Spring-loaded flip-lid covers receptacle when not in use
- Includes cover plate, rubber boot, stainless steel mounting plate/mounting screws
- Impact, chemical & corrosion resistant construction stands up to demanding environments
- Mounts easily to any FS and FD boxes and any flat surface

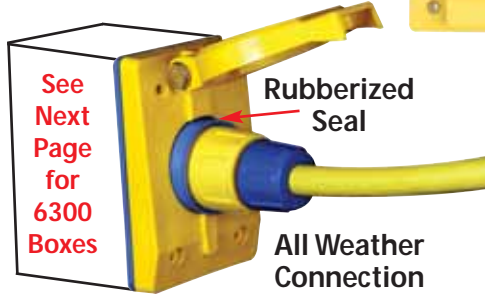
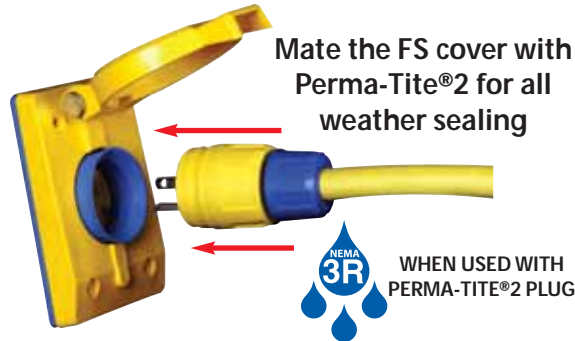

- Also Available in:
- Green
  - Black
  - Sand



## PERMA-TITE®2 Single Outlet Cover Plates - FS Series

Face View	NEMA Configuration	Electrical Ratings		FS Female Receptacle	2705 Male Inlet Std Opening	2705 Male Inlet Large Opening
		Amps	Volts			
<b>15A Straight Blade &amp; Locking 20A Straight Blade</b>						
Flip Seal Cover w/ weatherproof boot only				<b>2700-FS<sup>(1)</sup></b>	1 1/16" Dia.	2" Dia.
	Non-NEMA	10/15 Amp	125/250 Volt	<b>2715FS07</b>		
	5-15	15 Amp	125 Volt	<b>2715-FS10</b>	2705-15	2705-15A
	5-20	20 Amp	125 Volt	<b>2715-FS12</b>	2705-20	2705-20A
	6-15	15 Amp	250 Volt	<b>2715-FS14</b>		
	6-20	20 Amp	250 Volt	<b>2715-FS16</b>		
	L5-15	15 Amp	125 Volt	<b>2715-FS20</b>	2705-L15	2705-L15A
	L6-15	15 Amp	250 Volt	<b>2715-FS22</b>		
	L7-15	15 Amp	277 Volt	<b>2715-FS24</b>		
<b>20A &amp; 30A Locking, 3-Wire</b>						
Flip Seal Cover w/ weatherproof boot only				<b>2800-FS<sup>(1)</sup></b>	2 1/8" Dia.	
	L5-20	20 Amp	125 Volt	<b>2820-FS10</b>	2705-L20	
	L6-20	20 Amp	250 Volt	<b>2820-FS12</b>		
	L7-20	20 Amp	277 Volt	<b>2820-FS14</b>		
	Non-NEMA	20 Amp	125/250 Volt	<b>2820-FS16</b>		
	Non-NEMA	20 Amp/10 Amp	250 Volt/600 Volt	<b>2820-FS17</b>		
	L5-30	30 Amp	125 Volt	<b>2830-FS10</b>		
	L6-30	30 Amp	250 Volt	<b>2830-FS12</b>		
	L7-30	30 Amp	277 Volt	<b>2830-FS14</b>		
	Non-NEMA	30 Amp	125/250 Volt	<b>2830-FS16</b>		
<b>20A &amp; 30A Locking, 4-Wire</b>						
Flip Seal Cover w/ weatherproof boot only				<b>2900-FS<sup>(1)</sup></b>	2 1/8" Dia.	
	L14-20	20 Amp	125/250 Volt	<b>2920-FS20</b>	2705-L142	
	L15-20	20 Amp	250 Volt, 3 ø	<b>2920-FS22</b>		
	L16-20	20 Amp	480 Volt, 3 ø	<b>2920-FS24</b>	2705-L162	
	L14-30	30 Amp	125/250 Volt	<b>2930-FS20</b>		
	L15-30	30 Amp	250 Volt, 3 ø	<b>2930-FS22</b>		
	L16-30	30 Amp	480 Volt, 3 ø	<b>2930-FS24</b>		
	L17-30	30 Amp	600 Volt, 3 ø	<b>2930-FS26</b>		
	L18-30	30 Amp	120/208 Volt, 3 ø wye	<b>2930-FS30</b>		
	Non-NEMA	30 Amp	120/208 Volt, 3 ø wye	<b>2930-FS28</b>		

**NOTES:**

1. Does not include receptacle. Use with standard receptacles of same electrical ratings.

## Single Male Inlet Assemblies with Cover Plates - 2705 FS Series

- Weather resistant boot seals around the connector to provide weather resistant protection
- Spring-loaded flip-lid covers inlet when not in use
- Includes cover plate, rubber boot, stainless steel mounting plate/mounting screws
- Impact, chemical & corrosion resistant construction stands up to demanding environments
- Mounts easily to any 6300 series FS/FD boxes and any flat surface
- Spring Loaded SS hardware flip cover



### Application Notes:

The 2705 series of male inlets is designed for all weather power inlet on a variety of applications. The heavy duty flip cover assembly and superior round sealing collar provides a superior seal against the elements. Use for inlet power only. Never use these devices for power output or receptacle. These devices must be wired dead and cannot be accidentally energized without a connector in place.

- Power inlet for powered food trolley carts
- Power inlet for machines in tough environments
- Power charging inlet for fire trucks, ambulances and electric service vehicles
- Power inlet for portable temporary power panels
- Power charging port for electric battery cars or golf carts



Also available in all black or customized - call Ericson for details



## 6300 Series Boxes for FS Series Mounting

Part Number	Description	Color
6312FS	Box, Std Depth, 6300, No bushing, 1/2" NPT	Yellow
6334FS	Box, Std Depth, 6300, No bushing, 3/4" NPT	Yellow
6310FS	Box, Std Depth, 6300, No bushing, 1" NPT	Yellow
6312FD	Box, Deep, 6300, No bushing, 1/2" NPT	Yellow
6334FD	Box, Deep, 6300, No bushing, 3/4" NPT	Yellow
6310FD	Box, Deep, 6300, No bushing, 1" NPT	Yellow
<b>** ALL BLACK: add -BLK to part number for all black</b>		
<b>Boxes for 2705 - 1/2" NPT Bushing Installed (N=Non Metallic W = Wire Mesh)</b>		
6312NFS	Box, Std Depth, 6300, NM Bushing, 1/2" NPT	Yellow
6312NFD	Box, Deep, 6300, NM Bushing, 1/2" NPT	Yellow
6312WFS	Box, Std Depth, 6300, WireMesh Bushing, 1/2" NPT	Yellow
6312WFD	Box, Deep, 6300, WireMesh Bushing, 1/2" NPT	Yellow
<b>Boxes for 2705 - 3/4" NPT Bushing Installed (N=Non Metallic W = Wire Mesh)</b>		
6334NFS	Box, Std Depth, 6300, NM Bushing, 3/4" NPT	Yellow
6334NFD	Box, Deep, 6300, NM Bushing, 3/4" NPT	Yellow
6334WFS	Box, Std Depth, 6300, WireMesh Bushing, 3/4" NPT	Yellow
6334WFD	Box, Deep, 6300, WireMesh Bushing, 3/4" NPT	Yellow
<b>Boxes for 2705 - 1" NPT Bushing Installed (N=Non Metallic W = Wire Mesh)</b>		
6310NFS	Box, Std Depth, 6300, NM Bushing, 1" NPT	Yellow
6310NFD	Box, Deep, 6300, NM Bushing, 1" NPT	Yellow
6310NFT	Box, OPEN, 6300, NM Bushing, 1" NPT	Yellow
6310WFS	Box, Std Depth, 6300, WireMesh Bushing, 1" NPT	Yellow
6310WFD	Box, Deep, 6300, WireMesh Bushing, 1" NPT	Yellow
6310WFT	Box, OPEN, 6300, WireMesh Bushing, 1" NPT	Yellow
<b>** ALL BLACK: add -BLK to part number for all black</b>		

(NM) Non Metallic Bushing Kits			Wire Mesh Grips	Wall/Post Mount Kit 6260 WK
82005 - 1/2"	82034 - 3/4"	82010 - 1"		
<p>Kit</p>			<p>82005W = 1/2" 82034W = 3/4" 82010W = 1"</p>	<p>Fits 6300 Series Boxes</p>

FT Feed Thru Box

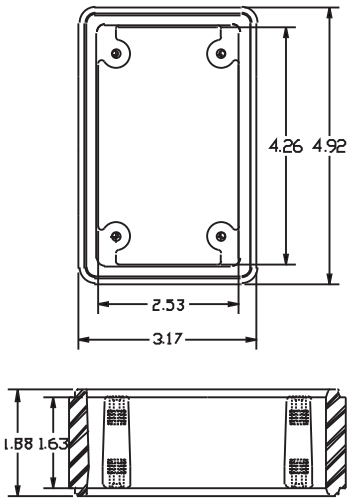

FD Deep Box

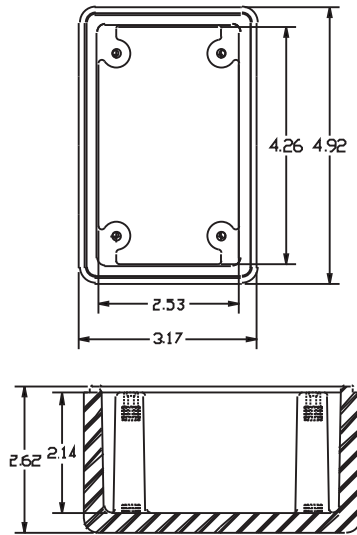

FS Standard Box

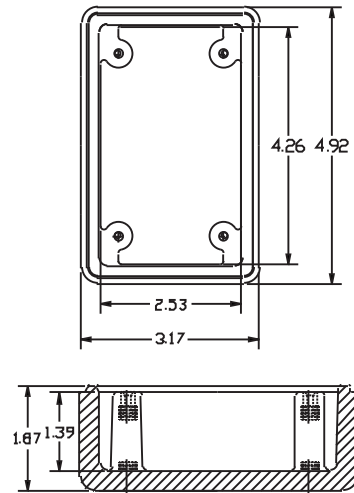

Mounting Templates

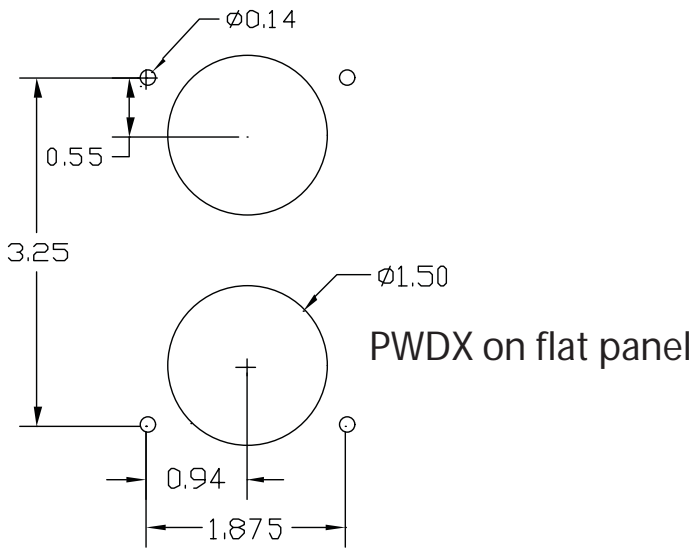

6260 WK Wall Kit

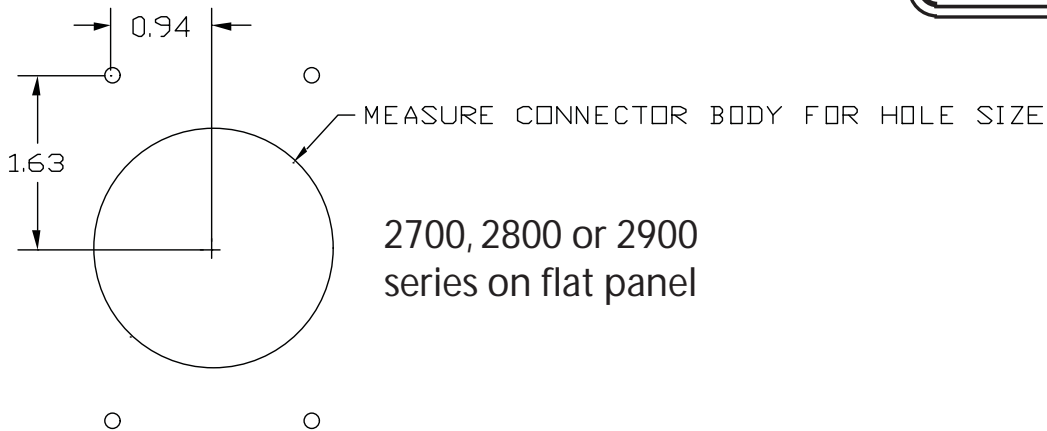
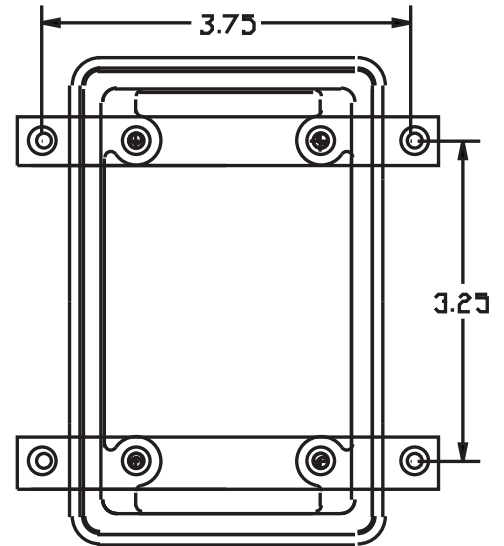



## NEMA Configuration Adapters

Now make quick, secure connections between straight-blade and locking plugs and connectors with Ericson's NEMA configuration adapters.

- Heavy-duty non-conducting housing and using heavy gauge solid brass blades
- Compact size makes them easy to use and transport
- Available in four of the most popular models

## NEMA Configuration Adapters Selection Guide



Catalog Number	NEMA Configuration		Description
	Male	Female	
1705			Male 15A, 125V twist (L5-15P) to 20A, 125V straight (5-20R)
1712			Male 15A, 125V straight (5-15P) to 15A, 125V twist (L5-15R)
1740			Male 20A, 125V twist (L5-20P) to 20A, 125V straight (5-20R)
1744			Male 15A, 125V straight (5-15P) to 20A, 125V twist (L5-20R)
123-20P15C			Male 20A, 125V twist (L5-20P) to 15A, 125V straight (5-15R)
123-15P20C			Male 15A, 125V straight (5-15P) to 20A, 125V twist (L5-20R)

## PERMA-TITE® 2 Plug Cover

- Use with Ericson's Perma-Tite® plugs to seal out water, dust and other contaminants and to protect blades from damage when plug is not in-use
- Eight-point rubber tongue and groove sealing system provides environmental protection
- Additional protection provided by a unique internal water/dust wiper
- Easy to assemble
- Ericson's Radiant Yellow for High Visibility on job sites



15PW with 1510-PW6P Plug

## PERMA-TITE® 2 Plug Cover Selection Guide

Catalog Number	Description
15PW	Male closure cap, for use with 15A Straight Blade & Locking devices and 20A Straight Blade devices.
16CW	Female replacement cover for CW6P connectors
24CW	Female Large replacement cover for CW6P connectors
26CW	Female 30 Amp Large replacement cover for CW6P connectors



16CW - Fits 16XXCW6P Connectors



24CW - Fits 24XXCW6P Connectors  
26CW - Fits 26XXCW6P Connectors





## Hospital Grade Perma-Link® Plugs and Connectors

The same rugged internal construction as our standard Perma-Link line is found in these units, and in addition they meet UL Hospital Grade standards. Designed for reliable long life, built to withstand exceptional abuse, these dead-front, back-wired devices save installation time, provide maximum protection and can be used for straight blade installations in hospitals, schools, and extended care facilities. Constructed of rugged polybutylene terephthalate (PBT) and a high-tech thermoplastic elastomer (TPE), they have passed tests for ground pin retention, ground resistance, face impact, ground temperature contact, fault current, line blade retention and abrupt removal.

### INSULATED/INSTITUTION GRAY RUBBER COVER

White and light "institution" gray colors identify this style which provides superior insulation. They are clearly marked "Hospital Grade" and clearly marked with a green dot to signify UL Hospital Grade. Non-conductive cord clamp to accommodate cord sizes #16/3 SJ through #12/3 SO.

### FAST WIRING CHECK THROUGH CLEAR COVER

White PBT and transparent polycarbonate housing identify this type which permits visual inspection of wiring terminations without disassembly. Impact resistance, and non-conductive. Cord clamp has removable insert to accommodate #16/3 SJTW through #12/3 SO cord sizes.

## PERMA-LINK® Hospital Grade Selection Guide

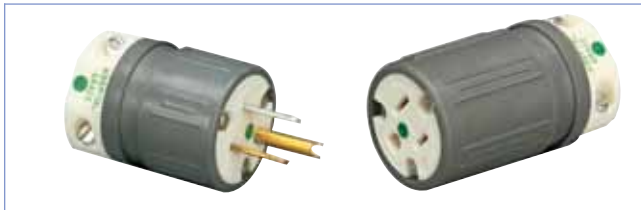

Hospital Grade Devices with Gray Covers

Face View	NEMA Configuration	Electrical Ratings		Perma-Link	
		Amps	Volts	Plugs	Connectors
	5-15	15	125	1530-PH	1630-CH
	5-20	20	125	1532-PH	1632-CH

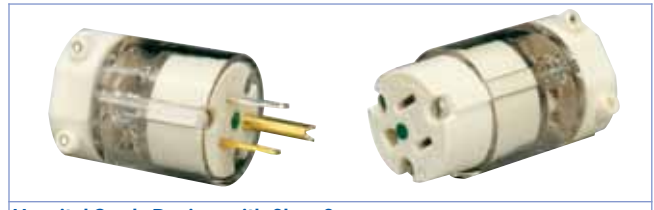

Hospital Grade Devices with Clear Covers  
Straight Blade, 2-pole, 3-wire Grounding

Face View	NEMA Configuration	Electrical Ratings		Perma-Link	
		Amps	Volts	Plugs	Connectors
	5-15	15	125	1530-PHC	1630-CHC
	5-20	20	125	1532-PHC	1632-CHC

## EML520R & EML630R

Ericson offers our same heavy duty receptacles that we use in our own Temporary Power Panels. These wiring devices are primarily used in our OSCAR series and can be used as replacement parts for those products. Features such as color coded screw terminals with combo heads for ease of wiring makes these superior devices the best choice.



L6-30

EML630R



L5-20

EML520R

## PERMA-LINK® 50Amp Locking Plugs and Connectors

Ericson's 50 Amp plugs and connectors incorporate the latest technologies to provide wiring devices that are safer, faster to wire, lighter and easier to identify. These devices are available as plugs, connectors, inlets and receptacles and are available in 3 and 4 wire configurations.



- UL Listed, CSA Certified, CETLUS Listed
- Rugged nylon construction resists impact, corrosion and jobsite oils/chemicals
- Quick field assembly, no need to disassemble the entire device
- Nickel plated blades and stainless steel screws provide optimum corrosion resistance
- Optional heavy-duty weather-proof boots are available and provide added environmental protection and UV resistance
- Boots can be threaded together with the optional sealing collar system to provide maximum environmental protection
- Available in plugs, connectors, inlets and receptacles

### 50-Amp Devices Selection Guide



Face View	NEMA	Electrical Ratings		Perma-Link®		Receptacles	Flanged Inlets	Inlet with Flip Cover
	Configuration	Amps	Volts	Plugs	Connectors			
<b>Locking, 2-pole, 3-wire Grounding</b>								
	Non-NEMA	50	250VDC, 600VAC	3763-P	3762-C	3771	3777	
<b>Locking, 3-pole, 4-wire Grounding</b>								
	Non-NEMA	50	250VDC, 600VAC	3765-P	3764-C	3769	3775	
			250VDC, 600VAC	7765-P(1)	7764-C(1)	7379	7958	
<b>Locking, California Style, 2-pole, 3-wire Grounding</b>								
	Non-NEMA	50	250	CS8265-P	CS8264-C	CS8269	CS8275	
			480	CS8465-P	CS8464-C	CS8469	CS8475	
<b>Locking, California Style, 3-pole, 4-wire Grounding</b>								
	Non-NEMA	50	125/250	CS6365-P	CS6364-C	CS6369	CS6375	CS6375-F
			250, 3ø	CS8365-P	CS8364-C	CS8369	CS8375	
			480, 3ø	CS8165-P	CS8164-C	CS8169	CS8175	

**Notes:**

1. For replacement use only, not recommended for new installations
2. Contact factory for custom assemblies

Plug into Oscar™

Perma-Link® 50-Amp Accessories	Cat. Number
Weatherproof boot for plug or connector	7717
Sealing Collar for weatherproof boots	510-RR
Weatherproof receptacle cover	7788-CR



7788-CR



7717 Provides A Superior Seal With Our SR-50 Receptacle



7717

510-RR

7717

SR50

### Sealing Collar System

Our exclusive sealing collar system is available to provide maximum moisture protection between cordsets. The two boots are securely sealed together with threaded polycarbonate rings.

Commercial Grade



Commercial Grade

Insert Used	Cord Diameter
Both	Less than .220 - .450"
None	Over .460 - .650"

PERMA-LINK®

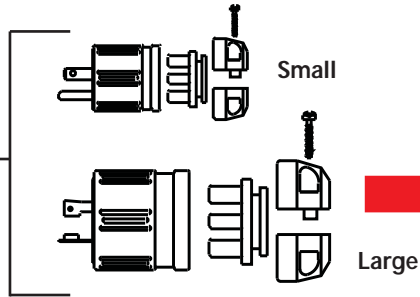

PERMA-LINK® Devices

Self centering cord clamp accommodates cord diameters	
Small	.335 - .720"
Med/Large	.360 - 1.0"

PERMA-GRIP™

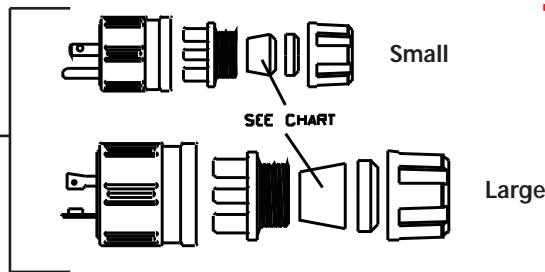

For Grommet Sizing

See Chart Next Page

PERMA-TITE® 2

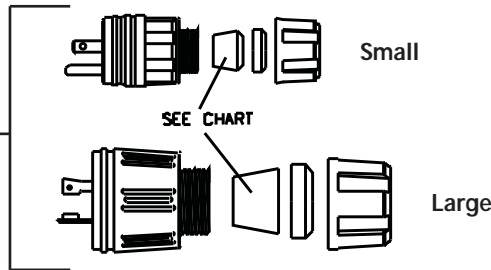

Strip Lengths

Dimensions in inches  
Round Cord Only

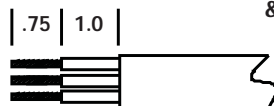
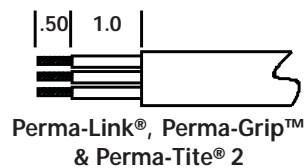
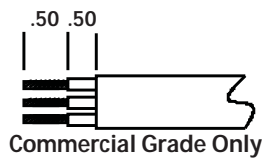
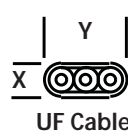

# Grommet Sizes

		B10200XX						B10220XX										
		Sm White OVAL # 24	Sm Orange OVAL # 25	Sm Yellow # 21	Sm White # 20	Sm Red # 16	Sm Blue # 18	Lg White # 91	Lg Yellow # 90	Lg Black # 89	Lg Blue # 88	Lg Gray # 87	Lg Red # 86	Lg Orange # 85				
MAX CORD DIA. (inch)		OVAL (UF) .160 x .360	OVAL (UF) .230 x .440	0.370	0.450	0.560	0.610	0.450	0.560	0.630	0.690	0.750	0.830	0.900	WIRE			
		Plug	Connector		Yellow	White*	Red	Blue	White*	Yellow	Black	Blue	Gray	Red	Orange	3	4	3Ø
1510	1610	✓ Optional**	✓ Optional**	✓	✓	✓	✓								X			
1512	1612			✓	✓	✓	✓									X		
1514	1614			✓	✓	✓	✓									X		
1516	1616			✓	✓	✓	✓									X		
1520	1620			✓	✓	✓	✓									X		
1522	1622			✓	✓	✓	✓									X		
1524	1624			✓	✓	✓	✓									X		
2310	2410							✓	✓	✓	✓				X			
2312	2412							✓	✓	✓	✓				X			
2314	2414							✓	✓	✓	✓				X			
2316	2416							✓	✓	✓	✓				X		X	
2317	2417							✓	✓	✓	✓				X			
2320	2420								✓	✓	✓	✓				X		
2322	2422								✓	✓	✓	✓				X	X	
2324	2424								✓	✓	✓	✓				X	X	
2510	2610							✓	✓	✓	✓				X			
2512	2612							✓	✓	✓	✓				X			
2514	2614							✓	✓	✓	✓				X			
2516	2616							✓	✓	✓	✓				X		X	
2520	2620										✓	✓	✓	✓		X		
2522	2622										✓	✓	✓	✓		X	X	
2524	2624										✓	✓	✓	✓		X	X	
2526	2626										✓	✓	✓	✓		X	X	
2528	2628										✓	✓	✓	✓		X	X	
2530	2630										✓	✓	✓	✓		X	X	

\* May also appear as light tan

\*\* May be ordered separately - Call Ericson for details

✓ = Included in package

## Diameter Ranges of Portable Electrical Cord In Accordance with UL 62

Type	AWG Size	2 Conductors	3 Conductors	4 Conductors
SJ, SJE, SJOO, SJO, SJEO, SJT, SJTO, SJTOO	18	0.280-0.315	0.300-0.335	0.325-0.365
	16	0.305-0.340	0.325-0.360	0.350-0.395
	14	0.335-0.375	0.360-0.395	0.390-0.435
	12	0.405-0.455	0.425-0.475	0.465-0.520
	10	0.540-0.605	0.565-0.635	0.625-0.700
S, SE, SOO, SO SEO, ST, STOO, STO	18	0.340-0.385	0.360-0.400	0.385-0.430
	16	0.365-0.410	0.385-0.430	0.410-0.460
	14	0.495-0.550	0.520-0.575	0.560-0.620
	12	0.565-0.625	0.590-0.655	0.640-0.710
	10	0.615-0.685	0.650-0.720	0.700-0.775
	8	0.780-0.880	0.830-0.930	0.925-1.050
	6	0.920-1.050	0.970-1.100	1.050-1.200
	4	1.060-1.210	1.130-1.280	1.250-1.450
2	1.210-1.400	1.300-1.500	1.450-1.650	