

IRWIN®

Fastener Drive & Screwdriving



www.irwin.com

Tools Manufactured for Strength and Value

Industry-Specific Screwdriver Bits

Fastener heads are often designed for the particular needs of specific applications and industries. The table below identifies the most common fastener styles used in each industry. All IRWIN fastener drive bits are manufactured to meet ANSI standards.

Features

- Made of high-grade S2 tool steel.
- Wide variety of point sizes to fit many different applications.
- On the Rockwell hardness scale, IRWIN bits are between 58-62.

INDUSTRY	PROFILE	Phillips®	Slotted	Square Recess	TORX®	Tamper Resistant TORX®	Hex	POZIDRIV®	TORQ-SET®	TRI-WING®	Spanner	Frearson	Clutch G	Clutch A
Appliance		•	•	•	•			•						
Automotive		•	•		•		•	•						
Aviation		•	•						•	•		•		
Cabinetry				•								•		
Construction		•	•					•						
Control Panels						•					•			
Decking		•	•	•				•						
Drywall		•		•										
Electronics		•	•		•	•	•	•	•	•				
Furniture		•	•	•			•							
Hobby		•	•			•						•	•	•
HVACR		•	•	•										
Machine Tools/Metal						•								
Manufactured Housing													•	•
Marine		•	•									•		
Recreation		•	•			•	•					•	•	•
Security				•	•	•		•	•	•	•			
Subfloor		•		•										

®TRI-WING, POZIDRIV, TORQ-SET, and Phillips are registered trademarks of the Phillips Screw Company.

®TORX is a registered trademark of Acument Intellectual Properties, LLC.

Phillips Bit Selection

The chart below shows the proper Phillips bit to use for driving each type of fastener.

Find the screw type and size you are driving. The column at the far left lists the proper point size to use.

Screw Type:	APPLICATION					
	Wood			Sheet Metal	Machine	
	Flat, Oval	Round	Flat, Oval, Binding	Flat, Oval, Round, Stove, Binding	Round Fillister	Truss Brazier Button
Phillips Bit Point Size	Size			Size	Size	
0	0, 1	0, 1	0, 1	0, 1	0, 1	0, 1
1	2, 3, 4	2, 3, 4	2, 3, 4	2, 3, 4	2, 3, 4	2, 3, 4, 5
2	5, 6, 7, 8, 9	5, 6, 7, 8, 9, 10	5, 6, 7, 8, 9, 10	5, 6, 7, 8, 9, 10	5, 6, 7, 8, 9, 10	6, 8, 10
3	10, 12, 14, 16	12, 14, 16	12, 14	12, 14	12, 1/4", 5/16"	12, 1/4"
4	18, 20, 24	18, 20, 24	5/16", 3/8", 7/16", 1/2"	—	3/8", 7/16", 1/2"	5/16", 3/8", 7/16", 1/2"

Impact Performance Series™ Screwdriving Bits are Built for Impact Drivers.

While most screwdriving bits are simply compatible with impact drills and drivers, IRWIN® Impact Performance Series™ fastener drive bits are engineered for maximum durability and long life with impact drivers. These bits are forged* rather than milled, so they fit fasteners more precisely, which reduces stripping and increases the life of the bit itself – IRWIN's Impact Performance Series bits have three times longer life than traditional bits. Manufactured with heavy-duty, cold-forged, high-grade steel, they'll withstand extremely high torque output. Plus, a black oxide finish resists corrosion and increases the life of the bit.

IMPACT SCREWDRIVING BIT FEATURES

1. Built for maximum durability and long life with impact drivers.
2. Forged* bit (vs. milled) for superior fitment, which reduces stripping and increases life of bit 3X.**
3. Manufactured with heavy-duty, cold-forged, high-grade steel to withstand high torque output.
4. Black oxide finish resists corrosion and increases life of bit.



3X
BIT LIFE**

IMPACT™ PERFORMANCE SERIES

Bit Life Comparison Chart*

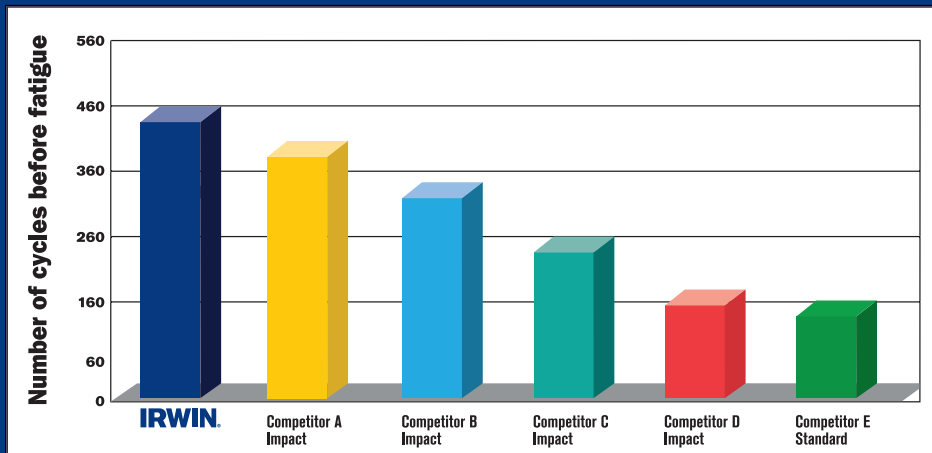

*Based on average life performance of Phillips, Square and Torx Impact Performance Series™ bits



FASTENER DRIVE

*Square and Phillips bits only
**vs. standard screwdriver bits

Fastener Drive & Screwdriving

Impact Screwdriving Bits



Phillips® Bits

Phillips Impact Insert Bits



1837327

Point Size	Shank Diameter	Overall Length	Carded Item # (2-pc)	Carded Item # (5-pc)	Bagged Item # (10-pc)	PRO-PAK™ (20-pc)	Item #*	Bulk Item # (25-pc)**
Phillips Insert Bits								
#1	1/4"	1"	1837324	—	—	—	1838481 (25-pc)	1837325
#2	1/4"	1"	1837327	1837328	1837329	1837377	1838482 (25-pc)	1837330
#2	1/4"	1"	—	—	—	—	1838483 (100-pc)	—
#2	1/4"	1"	—	—	—	—	1838484 (250-pc)	—
#3	1/4"	1"	1837375	—	—	—	1838485 (25-pc)	1837376

Point Size	Shank Diameter	Overall Length	Carded Item # (1-pc)	Carded Item # (5-pc)	Bagged Item # (10-pc)	PRO-PAK™ (20-pc)	Item #*	Bulk Item # (25-pc)**
Phillips Drywall Insert Bits								
#2	1/4"	1"	1837371	1837372	1837373	1837378	—	1837374

Phillips Impact Power Bits

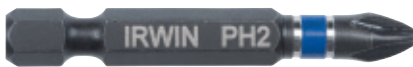

1837453

FASTENER DRIVE

Point Size	Shank Diameter	Overall Length	Carded Item # (1-pc)	Carded Item # (2-pc)	Carded Item # (5-pc)	Item #*	Bulk Item # (10-pc)**
#1	1/4"	2"	—	1837435	—	—	1837436
#1	1/4"	3"	1837437	—	—	—	1837438
#1	1/4"	4"	1837439	—	—	—	1837440
#1	1/4"	6"	1837451	—	—	—	1837452
#2	1/4"	2"	—	1837453	1837454	1838486 (10-pc)	1837455
#2	1/4"	2"	—	—	—	1838487 (100-pc)	—
#2	1/4"	2"	—	—	—	1838488 (250-pc)	—
#2	1/4"	3"	1837456	—	—	1838489 (10-pc)	1837457
#2	1/4"	3"	—	—	—	1838490 (100-pc)	—
#2	1/4"	4"	1837458	—	—	—	1837459
#2	1/4"	6"	1837460	—	—	1838491 (10-pc)	1837461
#2	1/4"	6"	—	—	—	1838492 (100-pc)	—
#3	1/4"	2"	—	1837433	—	1838493 (10-pc)	1837434
#3	1/4"	2"	—	—	—	1838494 (100-pc)	—
#3	1/4"	3"	1837462	—	—	1838495 (10-pc)	1837463
#3	1/4"	4"	1837464	—	—	—	1837465
#3	1/4"	6"	1837466	—	—	—	1837467



Square Recess Bits

Square Recess Impact Insert Bits



1837381

Point Size	Shank Diameter	Overall Length	Carded Item # (2-pc)	Carded Item # (5-pc)	Bagged Item # (10-pc)	PRO-PAK™ (20-pc)	Item #*	Bulk Item # (25-pc)**
#1	1/4"	1"	1837379	—	—	—	1838496 (25-pc)	1837380
#2	1/4"	1"	1837381	1837382	1837383	1837387	1838497 (25-pc)	1837384
#3	1/4"	1"	1837385	—	—	—	—	1837386

*One unit equals one bag of bits containing listed quantity of individual bits. For example, order **one unit** to receive one bag of 25 bits.

One unit equals one individual bit. For example, order **25 units to receive one bag of 25 bits.

Square Recess Impact Power Bits



1837476

Point Size	Shank Diameter	Overall Length	Carded Item # (1-pc)	Carded Item # (2-pc)	Carded Item # (5 -pc)	Item #*	Bulk Item # (10-pc)**
#1	1/4"	2"	—	1837468	—	—	1837469
#1	1/4"	3"	1837470	—	—	—	1837471
#1	1/4"	4"	1837472	—	—	—	1837473
#1	1/4"	6"	1837474	—	—	—	1837475
#2	1/4"	2"	—	1837476	1837478	1838498 (10-pc)	1837477
#2	1/4"	3"	1837479	—	—	—	1837480
#2	1/4"	4"	1837481	—	—	—	1837482
#2	1/4"	6"	1837483	—	—	—	1837484
#3	1/4"	2"	—	1837485	—	—	1837486
#3	1/4"	3"	1837487	—	—	—	1837488
#3	1/4"	4"	1837489	—	—	—	1837490
#3	1/4"	6"	1837491	—	—	—	1837492



TORX® Bits

TORX Impact Insert Bits



1837404

Point Size	Shank Diameter	Overall Length	Carded Item # (1-pc)	Carded Item # (5-pc)	Bagged Item # (10-pc)	Item #*	Bulk Item # (25-pc)**
T6	1/4"	1"	1837390	—	—	—	1837391
T7	1/4"	1"	1837392	—	—	—	1837393
T8	1/4"	1"	1837394	—	—	1838499 (25-pc)	1837395
T9	1/4"	1"	1837396	—	—	1838500 (25-pc)	1837397
T10	1/4"	1"	1837398	—	—	—	1837399
T15	1/4"	1"	1837400	—	—	1838501 (25-pc)	1837401
T20	1/4"	1"	1837402	—	—	1838502 (25-pc)	1837403
T20	1/4"	1"	—	—	—	1838503 (250-pc)	—
T25	1/4"	1"	1837404	1837406	1837407	1838504 (25-pc)	1837405
T25	1/4"	1"	—	—	—	1838505 (250-pc)	—
T27	1/4"	1"	1837408	—	—	1838506 (25-pc)	1837409
T30	1/4"	1"	1837410	—	—	1838507 (25-pc)	1837411
T30	1/4"	1"	—	—	—	1838508 (250-pc)	—
T40	1/4"	1"	1837412	—	—	1838509 (25-pc)	1837413
TORX Impact Insert Bit Sets							
T10 & T15	1/4"	1"	1837388	—	—	—	—
T20 & T25	1/4"	1"	1837389	—	—	—	—



Tamper-Resistant TORX Bits

TORX Tamper-Resistant Impact Insert Bits



1837425

Point Size	Shank Diameter	Overall Length	Carded Item # (1-pc)	Item #*	Bulk Item # (25-pc)**
T7	1/4"	1"	1837415	1838529 (25-pc)	—
T8	1/4"	1"	1837416	1838530 (25-pc)	—
T9	1/4"	1"	1837417	1838531 (25-pc)	1837418
T10	1/4"	1"	1837419	1838532 (25-pc)	1837420
T15	1/4"	1"	1837421	1838533 (25-pc)	1837422
T20	1/4"	1"	1837423	1838534 (25-pc)	1837424
T20	1/4"	1"	—	1838535 (100-pc)	—
T25	1/4"	1"	1837425	1838536 (25-pc)	1837426
T25	1/4"	1"	—	1838537 (100-pc)	—
T27	1/4"	1"	1837427	1838538 (25-pc)	1837428
T30	1/4"	1"	1837429	1838539 (25-pc)	1837430
T30	1/4"	1"	—	1838540 (100-pc)	—
T40	1/4"	1"	1837431	1838541 (25-pc)	—
TORX Tamper-Resistant Impact Insert Bit Sets					
T10, T15, T20, T25, T27 & T30	1/4"	1"	1837414	—	—

*One unit equals one bag of bits containing listed quantity of individual bits. For example, order **one unit** to receive one bag of 25 bits.

One unit equals one individual bit. For example, order **25 units to receive one bag of 25 bits.

Fastener Drive & Screwdriving

Impact Screwdriving Bits and Socket Adapters



TORX® Bits

TORX Impact Power Bits



1837500

FASTENER DRIVE

Point Size	Shank Diameter	Overall Length	Carded Item # (1-pc)	Carded Item # (5-pc)	Item #*	Bulk Item # (10-pc)**
T10	1/4"	2"	1837494	—	1838510 (10-pc)	1837495
T10	1/4"	6"	1837522	—	1838511 (10-pc)	1837523
T15	1/4"	2"	1837496	—	1838512 (10-pc)	1837497
T15	1/4"	2-3/4"	1837510	—	—	1837511
T15	1/4"	3-1/2"	1837516	—	1838513 (10-pc)	1837517
T15	1/4"	6"	1837524	—	1838514 (10-pc)	1837525
T20	1/4"	2"	1837498	—	1838515 (10-pc)	1837499
T20	1/4"	2"	—	—	1838516 (100-pc)	—
T20	1/4"	2-3/4"	1837512	—	1838517 (10-pc)	1837513
T20	1/4"	3-1/2"	1837518	—	1838518 (10-pc)	1837519
T20	1/4"	6"	1837526	—	1838519 (10-pc)	1837527
T25	1/4"	2"	1837500	1837501	1838520 (10-pc)	1837502
T25	1/4"	2"	—	—	1838521 (100-pc)	—
T25	1/4"	2-3/4"	1837514	—	1838522 (10-pc)	1837515
T25	1/4"	3-1/2"	1837520	—	1838523 (10-pc)	1837521
T25	1/4"	6"	1837528	—	1838524 (10-pc)	1837529
T27	1/4"	2"	1837503	—	1838525 (10-pc)	1837504
T27	1/4"	2-3/4"	1837622	—	—	1837623
T27	1/4"	3-1/2"	1837626	—	—	1837627
T27	1/4"	6"	1837630	—	—	1837631
T30	1/4"	2"	1837505	1837506	1838526 (10-pc)	1837507
T30	1/4"	2"	—	—	1838527 (100-pc)	—
T30	1/4"	2-3/4"	1837624	—	—	1837625
T30	1/4"	3-1/2"	1837628	—	—	1837629
T30	1/4"	6"	1837632	—	—	1837633
T40	1/4"	2"	1837508	—	1838528 (10-pc)	1837509
TORX Impact Power Bit Sets						
T15, T20 & T25	1/4"	2"	1837493	—	—	—

Impact Socket Adapters



1837573

- Ball retention design for quick-change applications.
- Forged socket body

Square Drive	Lock Type	Overall Length	Carded Item # (1-pc)	Item # (5-pc)*	Bulk Item # (10-pc)**
1/4"	Ball	2"	1837571	1838557	1837574
3/8"	Ball	2"	1837572	1838558	1837575
1/2"	Ball	2"	1837573	1838559	1837576

— magnetic

*One unit equals one bag of bits containing listed quantity of individual bits. For example, order **one unit** to receive one bag of 25 bits.

One unit equals one individual bit. For example, order **25 units to receive one bag of 25 bits.



Nutsetters

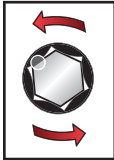

Lobular Design

IRWIN® Impact Performance Series™ lobular nutsetters are built for maximum durability, performance, and long life with impact tools. They are designed to drive the fastener from the side, rather than forcing the corners to turn, maintaining the true shape of the fastener and dramatically reducing breakage and damage from stripping. The lobular design also provides more clearance on the corners of the fastener where paint build-up often occurs. They are available with or without powerful rare earth magnets that hold fasteners securely in place. They have a black oxide finish that resists corrosion and increases the life of the nutsetter. Plus, with a 1/4" quick-change shank, they're designed to work with all types of impact and rotary drivers.

Impact Nutsetters - Lobular



1837533

Hex Drive	Socket Body Dia.	Shank Diameter	Overall Length	Carded Item # (1-pc)	Bagged Item # (3-pc)	Item # (5-pc)*	Bulk Item # (10-pc)**
1/4"	7/16"	1/4"	1-7/8"	1837533	1837534	1838542	1837535
5/16"	1/2"	1/4"	1-7/8"	1837536	1837537	1838544	1837538
3/8"	9/16"	1/4"	1-7/8"	1837539	1837540	1838543	1837541
7/16"	5/8"	1/4"	1-7/8"	1837542	1837543	—	1837544
1/4"	7/16"	1/4"	2-9/16"	1837545	1837964	1838547	1837546
5/16"	1/2"	1/4"	2-9/16"	1837547	1837548	1838549	1837549
3/8"	9/16"	1/4"	2-9/16"	1837550	1837551	1838548	1837552
7/16"	5/8"	1/4"	2-9/16"	1837553	1837554	1838550	1837555
1/4"	7/16"	1/4"	4"	1837556	—	1838551	1837557
5/16"	1/2"	1/4"	4"	1837558	—	1838553	1837559
3/8"	9/16"	1/4"	4"	1837560	—	1838552	1837561
1/4"	7/16"	1/4"	6"	1837562	—	1838554	1837563
5/16"	1/2"	1/4"	6"	1837564	—	1838556	1837565
3/8"	9/16"	1/4"	6"	1837566	—	1838555	1837567
1/4"	7/16"	1/4"	12"	1837568	—	—	—
5/16"	1/2"	1/4"	12"	1837569	—	1838545	—
3/8"	9/16"	1/4"	12"	1837570	—	—	—
Impact Nutsetter Sets							
1/4", 5/16", 3/8", 7/16"	1/4"	1-7/8"	1837530	—	—	—	
1/4", 5/16", 3/8"	1/4"	1-7/8"	1837531	—	—	—	
1/4", 5/16", 3/8"	1/4"	2-9/16"	1837532	—	—	—	

Impact Bit Holders



1837579

- C-ring design has internal clip that fits into the retaining ring notch of the insert bit to hold bit securely in place.
- Rare earth magnet holds fastener securely. Magnet is four times more powerful than standard magnets.

Type	Magnetic	Overall Length	Carded Item # (1-pc)	Item # (5-pc)*	Bulk Item # (10-pc)**
Standard with C-Ring	Yes	2-1/4"	1837577	1838560	1837578
Standard with C-Ring	Yes	3"	1837579	1838561	1837580

20-piece IRWIN® Impact PRO-PAK™



1837377

— magnetic

Contents	Quantity	PRO-PAK™ Item #
Insert Bit Impact #2 Phillips® X 1" OAL 2	20	1837377
Insert Bit Impact #2 Phillips-Drywall X 1" OAL	20	1837378
Insert Bit Impact #2 Square Recess X 1" OAL	20	1837387

*One unit equals one bag of bits containing listed quantity of individual bits. For example, order **one unit** to receive one bag of 25 bits.

One unit equals one individual bit. For example, order **25 units to receive one bag of 25 bits.

FASTENER DRIVE

Fastener Drive & Screwdriving

Impact Sets / Pro Sets

6-Piece Impact Quick-Change Set



1840313

Contents	Quantity	Item # 1840313
Impact Power Bit #1 Phillips® X 2" OAL	1	1837436
Impact Power Bit #2 Phillips X 2" OAL	2	1837455
Impact Power Bit #1 Square Recess X 2" OAL	1	1837469
Impact Power Bit #2 Square Recess X 2" OAL	1	1837477
1/4" Quick-Change Extension 2.5" OAL	1	4935703

14-Piece Impact Drive Guide Set



1840314

Contents	Quantity	Item # 1840314
Impact Insert Bit #1 Phillips X 1" OAL	2	1837325
Impact Insert Bit #2 Phillips X 1" OAL	4	1837330
Impact Insert Bit #1 Square Recess X 1" OAL	2	1837380
Impact Insert Bit #2 Square Recess X 1" OAL	4	1837384
Impact Bit Holder Magnetic with C-Ring X 2-1/4" OAL	1	1837578
Compact Magnetic Screw Guide - 3-1/16"	1	93551

Impact Pro Set Cases

IRWIN® professional fastener drive sets have convenient molded plastic cases that hold up anything the jobsite can throw at them.

FASTENER DRIVE

Pro Set Cases

FEATURES

1. Two-step easy in / out bit storage holds bits securely in place until ready for use.
2. Molded plastic case holds up to rigors of daily use.
3. Full-length metal pin in hinge for added durability and life.

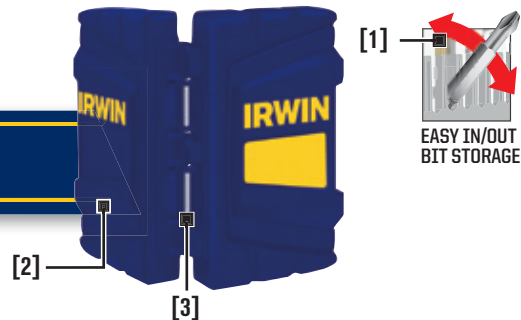

33-Piece Impact Fastener Drive Set



1840315

Contents	Quantity	Item # 1840315
Impact Insert Bit #1 Phillips X 1" OAL	2	1837325
Impact Insert Bit #2 Phillips X 1" OAL	3	1837330
Impact Insert Bit #3 Phillips X 1" OAL	2	1837376
Impact Insert Bit #1 Square Recess X 1" OAL	2	1837380
Impact Insert Bit #2 Square Recess X 1" OAL	3	1837384
Impact Insert Bit #3 Square Recess X 1" OAL	2	1837386
Impact Insert Bit T10 X 1" OAL	1	1837398
Impact Insert Bit T15 X 1" OAL	1	1837401
Impact Insert Bit T20 X 1" OAL	1	1837403
Impact Insert Bit T25 X 1" OAL	1	1837405
Impact Insert Bit T27 X 1" OAL	1	1837409
Impact Insert Bit T30 X 1" OAL	1	1837411
Impact Insert Bit T40 X 1" OAL	1	1837412
Impact Power Bit #2 Phillips X 2" OAL	2	1837455
Impact Power Bit #2 Square Recess X 2" OAL	1	1837477
Impact Power Bit T20 X 2" OAL	1	1837499
Impact Power Bit T25 X 2" OAL	1	1837502
Impact Power Bit T30 X 2" OAL	1	1837507
Impact Nutsetter Lobular Magnetic 1/4" X 3" OAL	1	1837546
Impact Nutsetter Lobular Magnetic 5/16" X 3" OAL	1	1837549
Impact Nutsetter Lobular Magnetic 3/8" X 3" OAL	1	1837552
Compact Magnetic Screw Guide - 3-1/16"	1	93551
Impact Socket Adapter 1/4" To 3/8" X 2" OAL	1	1837575
Impact Bit Holder Magnetic with C-Ring X 2-1/4" OAL	1	1837578

19-Piece Impact Drill/Drive Set



1840316

Contents	Quantity	Item # 1840316
1/16" Hex Shank Drill Bit	1	4935632
3/32" Hex Shank Drill Bit	1	4935634
1/8" Hex Shank Drill Bit	2	4935636
5/32" Hex Shank Drill Bit	1	4935638
3/16" Hex Shank Drill Bit	1	4935639
1/4" Hex Shank Drill Bit	1	4935641
Impact Insert Bit #1 Phillips X 1" OAL	1	1837325
Impact Insert Bit #2 Phillips X 1" OAL	2	1837330
Impact Insert Bit #3 Phillips X 1" OAL	1	1837376
Impact Insert Bit #2 Square Recess X 1" OAL	1	1837380
Impact Insert Bit #2 Square Recess X 1" OAL	1	1837384
Impact Insert Bit #3 Square Recess X 1" OAL	1	1837386
Impact Bit Holder Magnetic with C-Ring X 3" OAL	1	1837580
Impact Nutsetter Lobular Magnetic 1/4" X 3" OAL	1	1837546
Impact Nutsetter Lobular Magnetic 5/16" X 3" OAL	1	1837549
Impact Nutsetter Lobular Magnetic 3/8" X 3" OAL	1	1837552
Compact Magnetic Screw Guide - 3-1/16"	1	93551

32-Piece Impact Fastener Drive Set



1840317

Contents	Quantity	Item # 1840317
Impact Insert Bit #1 Phillips X 1" OAL	2	1837325
Impact Insert Bit #2 Phillips X 1" OAL	3	1837330
Impact Insert Bit #3 Phillips X 1" OAL	2	1837376
Impact Insert Bit #1 Square Recess X 1" OAL	2	1837380
Impact Insert Bit #2 Square Recess X 1" OAL	3	1837384
Impact Insert Bit #3 Square Recess X 1" OAL	2	1837386
Impact Insert Bit T10 X 1" OAL	1	1837398
Impact Insert Bit T15 X 1" OAL	1	1837401
Impact Insert Bit T20 X 1" OAL	1	1837403
Impact Insert Bit T25 X 1" OAL	2	1837405
Impact Insert Bit T27 X 1" OAL	1	1837409
Impact Insert Bit T30 X 1" OAL	1	1837411
Impact Power Bit #1 Phillips X 2" OAL	1	1837436
Impact Power Bit #2 Phillips X 2" OAL	2	1837455
Impact Power Bit #3 Phillips X 2" OAL	1	1837477
Impact Power Bit #1 Square Recess X 2" OAL	1	1837469
Impact Power Bit #2 Square Recess X 2" OAL	1	1837477
Impact Power Bit #3 Square Recess X 2" OAL	1	1837486
Impact Power Bit T20 X 2" OAL	1	1837499
Impact Power Bit T25 X 2" OAL	1	1837502
Impact Power Bit T30 X 2" OAL	1	1837507
Impact Bit Holder Magnetic with C-Ring X 3" OAL	1	1837580

33-Piece Impact Drill/Drive Set



1840318

Contents	Quantity	Item # 1840318
1/16" Hex Shank Drill Bit	1	4935632
5/64" Hex Shank Drill Bit	1	4935633
3/32" Hex Shank Drill Bit	1	4935634
7/64" Hex Shank Drill Bit	1	4935635
1/8" Hex Shank Drill Bit	2	4935636
9/64" Hex Shank Drill Bit	1	4935637
5/32" Hex Shank Drill Bit	1	4935638
3/16" Hex Shank Drill Bit	1	4935639
7/32" Hex Shank Drill Bit	1	4935640
1/4" Hex Shank Drill Bit	1	4935641
Impact Insert Bit #1 Phillips X 1" OAL	2	1837325
Impact Insert Bit #2 Phillips X 1" OAL	3	1837330
Impact Insert Bit #3 Phillips X 1" OAL	2	1837376
Impact Insert Bit #1 Square Recess X 1" OAL	2	1837380
Impact Insert Bit #2 Square Recess X 1" OAL	3	1837384
Impact Insert Bit #3 Square Recess X 1" OAL	2	1837386
Impact Insert Bit T10 X 1" OAL	1	1837398
Impact Insert Bit T15 X 1" OAL	1	1837401
Impact Insert Bit T20 X 1" OAL	1	1837403
Impact Insert Bit T25 X 1" OAL	2	1837405
Impact Insert Bit T27 X 1" OAL	1	1837409
Impact Insert Bit T30 X 1" OAL	1	1837411
Impact Bit Holder Magnetic with C-Ring X 3" OAL	1	1837580

Fastener Drive & Screwdriving

Impact Pro Sets

32-Piece Impact Drill/Drive Set



1840319

Contents	Quantity	Item # 1840319
1/16" Hex Shank Drill Bit	1	4935632
5/64" Hex Shank Drill Bit	1	4935633
3/32" Hex Shank Drill Bit	1	4935634
7/64" Hex Shank Drill Bit	1	4935635
1/8" Hex Shank Drill Bit	2	4935636
9/64" Hex Shank Drill Bit	1	4935637
5/32" Hex Shank Drill Bit	1	4935638
3/16" Hex Shank Drill Bit	1	4935639
7/32" Hex Shank Drill Bit	1	4935640
1/4" Hex Shank Drill Bit	1	4935641
Impact Insert Bit #2 Phillips X 1" OAL 20/Tic Tac	1	1837377
1/4" Quick-Change Extension 2.5" OAL	1	4935703

47-Piece Impact Screwdriver Bit Set



1840392

Contents	Quantity	Item # 1840392
Impact Insert Bit #1 Phillips X 1" OAL	3	1837325
Impact Insert Bit #2 Phillips X 1" OAL	7	1837330
Impact Insert Bit #3 Phillips X 1" OAL	4	1837376
Impact Insert Bit #2 Square Recess X 1" OAL	3	1837380
Impact Insert Bit #2 Square Recess X 1" OAL	7	1837384
Impact Insert Bit #3 Square Recess X 1" OAL	4	1837386
Impact Insert Bit T15 X 1" OAL	1	1837401
Impact Insert Bit T20 X 1" OAL	1	1837403
Impact Insert Bit T25 X 1" OAL	3	1837405
Impact Insert Bit T27 X 1" OAL	1	1837409
Impact Insert Bit T30 X 1" OAL	1	1837411
Impact Power Bit #2 Phillips X 2" OAL	4	1837455
Impact Power Bit #2 Square Recess X 2" OAL	2	1837477
Impact Power Bit T20 X 2" OAL	1	1837499
Impact Power Bit T25 X 2" OAL	1	1837502
Compact Magnetic Screw Guide - 3-1/16"	1	93551
Impact Nutsetter Lobular Magnetic 1/4" X 2-9/16" OAL	1	1837546
Impact Nutsetter Lobular Magnetic 5/16" X 2-9/16" OAL	1	1837549
Impact Nutsetter Lobular Magnetic 3/8" X 2-9/16" OAL	1	1837552

26-Piece Impact Screwdriver Bit Set



1840393

Contents	Quantity	Item # 1840393
Impact Insert Bit #2 Phillips X 1" OAL	4	1837330
Impact Insert Bit #2 Square Recess X 1" OAL	3	1837384
Impact Power Bit #1 Phillips X 2" OAL	1	1837436
Impact Power Bit #2 Phillips X 2" OAL	2	1837455
Impact Power Bit #3 Phillips X 2" OAL	1	1837477
Impact Power Bit #2 Square Recess X 2" OAL	1	1837469
Impact Power Bit #2 Square Recess X 2" OAL	3	1837477
Impact Power Bit #3 Square Recess X 2" OAL	1	1837486
Impact Power Bit #2 Phillips X 4" OAL	1	1837459
Impact Power Bit #2 Square Recess X 4" OAL	1	1837482
Impact Power Bit T20 X 2" OAL	1	1837499
Impact Power Bit T25 X 2" OAL	1	1837502
Impact Power Bit T30 X 2" OAL	1	1837507
Compact Magnetic Screw Guide - 3-1/16"	1	93551
Impact Nutsetter Lobular Magnetic 1/4" X 2-9/16" OAL	1	1837546
Impact Nutsetter Lobular Magnetic 5/16" X 2-9/16" OAL	1	1837549
Impact Nutsetter Lobular Magnetic 3/8" X 2-9/16" OAL	1	1837552
1/4" Quick-Change Extension 2.5" OAL	1	4935703

FASTENER DRIVE

16-Piece Impact Automotive Set



1840320

Contents	Quantity	Item # 1840320
Impact Power Bit #1 Phillips X 6" OAL	1	1837452
Impact Power Bit #2 Phillips X 3" OAL	1	1837457
Impact Power Bit #2 Phillips X 6" OAL	1	1837461
Impact Power Bit #3 Phillips X 3" OAL	1	1837463
Impact Power Bit T15 X 3" OAL	1	1837511
Impact Power Bit T20 X 3" OAL	1	1837513
Impact Power Bit T20 X 6" OAL	1	1837527
Impact Power Bit T25 X 6" OAL	1	1837529
Impact Power Bit T27 X 3" OAL	1	1837623
Impact Power Bit T27 X 6" OAL	1	1837631
Impact Power Bit T30 X 6" OAL	1	1837633
Impact Nutsetter Lobular Magnetic 5/16" X 2" OAL	1	1837538
Impact Socket Adapter 1/4" To 1/4" X 3" OAL	1	1837574
Impact Socket Adapter 1/4" To 3/8" X 2" OAL	1	1837575
1/4" Impact Extension 2.5" OAL	1	1857571
1/4" Impact Extension 6" OAL	1	1857572

34-Piece Impact Automotive Set



1840391

Contents	Quantity	Item # 1840391
Impact Power Bit #1 Phillips X 2" OAL	1	1837436
Impact Power Bit #2 Phillips X 2" OAL	1	1837455
Impact Power Bit #3 Phillips X 2" OAL	1	1837434
Impact Power Bit T10 X 2" OAL	1	1837495
Impact Power Bit T15 X 2" OAL	1	1837497
Impact Power Bit T20 X 2" OAL	1	1837499
Impact Power Bit T27 X 2" OAL	1	1837504
Impact Power Bit T30 X 2" OAL	1	1837507
Impact Power Bit T40 X 2" OAL	1	1837509
Impact Power Bit #1 Phillips X 3" OAL	1	1837438
Impact Power Bit #2 Phillips X 3" OAL	1	1837457
Impact Power Bit #3 Phillips X 3" OAL	1	1837463
Impact Power Bit T15 X 3-1/2" OAL	1	1837517
Impact Power Bit T20 X 3-1/2" OAL	1	1837519
Impact Power Bit T25 X 3-1/2" OAL	1	1837521
Impact Power Bit T27 X 3-1/2" OAL	1	1837627
Impact Power Bit T30 X 3-1/2" OAL	1	1837629
Impact Power Bit #1 Phillips X 6" OAL	1	1837452
Impact Power Bit #2 Phillips X 6" OAL	1	1837461
Impact Power Bit #3 Phillips X 6" OAL	1	1837467
Impact Power Bit T15 X 6" OAL	1	1837525
Impact Power Bit T20 X 6" OAL	1	1837527
Impact Power Bit T25 X 6" OAL	1	1837529
Impact Power Bit T27 X 6" OAL	2	1837631
Impact Power Bit T30 X 6" OAL	1	1837633
Impact Socket Adapter 1/4" To 1/4" X 3" OAL	1	1837574
Impact Socket Adapter 1/4" To 3/8" X 2" OAL	1	1837575
Impact Socket Adapter 1/4" To 1/2" X 2" OAL	1	1837576
Impact Nutsetter Lobular Magnetic 1/4" X 2" OAL	1	1837535
Impact Nutsetter Lobular Magnetic 5/16" X 2" OAL	1	1837538
Impact Nutsetter Lobular Magnetic 3/8" X 2" OAL	1	1837541
1/4" Impact Extension 2.5" OAL	1	1857571
1/4" Impact Extension 6" OAL	1	1857572

FASTENER DRIVE

Screwdriving Bits

IRWIN® offers a full line of screwdriving bits designed for just about any application imaginable. All are manufactured with industrial-grade S2 steel for maximum life and durability.



Phillips Insert Bits



92011

Point Size	Shank Diameter	Overall Length	Carded Item #	Bagged Item #	PRO-PAK™ (20-pc)	Bulk Item # (25-pc)
#0	1/4"	1"	3053008 (2-pc)	—	—	92001
#1	1/4"	1"	3510052C (2-pc)	—	—	92005
#1	1/4"	1-1/2"	—	—	—	92025
#1	5/16"	1-1/4"	—	—	—	92073
#2	1/4"	1"	3510112C (2-pc)	3510115B (5-pc)	357320	92011
#2	1/4"	1"	3510115C (5-pc)	351011XB (10-pc)	—	—
#2	1/4"	1"	351011XC (10-pc)	35101125 (25-pc)	—	—
#2	1/4"	1-1/2"	—	—	—	92027
#2	5/16"	1-1/4"	—	—	—	92075ZR
#2	1/4"	2"	—	—	—	92039
#2	1/4"	2-1/2"	—	—	—	92045
#3	1/4"	1"	3510192C (2-pc)	—	—	92019
#3	1/4"	1-1/2"	—	—	—	92035
#3	5/16"	1-1/4"	—	—	—	92077
#4	5/16"	1-1/4"	—	—	—	92079ZR

Phillips Drywall Insert Bits



92047

Point Size	Shank Diameter	Overall Length	Carded Item #	Bagged Item #	PRO-PAK™ (20-pc)	Bulk Item # (25-pc)
#1	1/4"	1"	—	—	—	92007
#2	1/4"	1"	3510472C (2-pc)	351047XB (10-pc)	357120	92047
#2	1/4"	1"	3510475C (5-pc)	35104725 (25-pc)	—	—
#2	1/4"	1"	351047XC (10-pc)	—	—	—
#2	1/4"	2"	—	—	—	92053

Phillips Drywall Screwsetter



351064

Point Size	Shank Diameter	Overall Length	Carded Item # (1-pc)	Bagged Item # (3-pc)	Bulk Item # (25-pc)
#2	1/4"	1"	3510641C	3510643B	351064

Phillips Power Bits



93007

Point Size	Shank Diameter	Overall Length	Carded Item # (1-pc)	Carded Item # (2-pc)	Carded Item # (5-pc)	Bagged Item # (5-pc)	Bulk Item # (10-pc)
#1	1/4"	2"	3520031C	3052007	—	—	93003ZR
#1	1/4"	2-3/4"	—	—	—	—	93017
#1	1/4"	3"	—	—	—	—	93043
#1	1/4"	3-1/2"	3520231C	—	—	—	93023
#1	1/4"	4"	—	—	—	—	93053
#1	1/4"	6"	—	—	—	—	93063
#2	1/4"	2"	3520071C	—	3520075C	3520075B	93007ZR
#2	1/4"	2-3/4"	—	3052009	—	—	93019
#2	1/4"	3"	—	—	—	—	93047
#2	1/4"	3-1/2"	3520251C	—	—	—	93025
#2	1/4"	4"	—	—	—	—	93057
#2	1/4"	6"	3520671C	—	—	—	93067
#3	1/4"	1-15/16"	3520111C	—	—	—	93011
#3	1/4"	2-3/4"	—	—	—	—	93021
#3	1/4"	3"	—	—	—	—	93049
#3	1/4"	3-1/2"	3520291C	—	—	—	93029
#3	1/4"	4"	—	—	—	—	93059
#3	1/4"	6"	3520691C	—	—	—	93069
Power Bit Sets							
#1, #2, & #3/4"		2"					3521993C

FASTENER DRIVE



Square Recess Bits

Square Recess Insert Bits



92205

Point Size	Shank Diameter	Overall Length	Carded Item # (2-pc)	Bagged Item # (5-pc)	Bagged Item # (10-pc)	Bagged Item # (25-pc)	PRO-PAK™ (20-pc)	Bulk Item # (25-pc)
#0	1/4"	1"	—	3052007	—	—	—	92201
#1	1/4"	1"	3512032C	—	—	—	—	92203
#2	1/4"	1"	3512052C	3512055B	351205XB	35120525	357220	92205
#3	1/4"	1"	3512072C	—	—	—	—	92207

Square Recess 2-Piece Design Insert Bits



92225

- Cold-forged tip for added durability.

Point Size	Shank Diameter	Overall Length	Carded Item # (2-pc)	PRO-PAK™ (20-pc)	Bulk Item # (25-pc)
#0	1/4"	1"	—	—	92221
#1	1/4"	1"	3512232C	—	92223
#2	1/4"	1"	3512252C	357220C	92225
#3	1/4"	1"	3512272C	—	92227

Square Recess Power Bits



93205

Point Size	Shank Diameter	Overall Length	Carded Item # (1-pc)	Carded Item # (5-pc)	Bulk Item # (10-pc)
#1	1/4"	2"	3522031C	—	93203
#1	1/4"	2-3/4"	—	—	93211
#1	1/4"	3"	93219C	—	93219
#1	1/4"	4"	—	—	93225
#1	1/4"	6"	—	—	93230ZR
#2	1/4"	2"	3522051C	3522055C	93205
#2	1/4"	2-3/4"	—	—	93213
#2	1/4"	3"	93221C	—	93221
#2	1/4"	4"	—	—	93226
#2	1/4"	6"	3522311C	—	93231
#3	1/4"	2"	3522071C	—	93207
#3	1/4"	2-3/4"	—	—	93215
#3	1/4"	3"	4935199	—	93223
#3	1/4"	4"	—	—	93227
#3	1/4"	6"	—	—	93232

FASTENER DRIVE

Fastener Drive & Screwdriving

Screwdriving Bits

Square Recess 2-Piece Design Power Bits



93239

- Cold-forged tip for added durability.

Point Size	Shank Diameter	Overall Length	Carded Item # (1-pc)	Carded Item # (5-pc)	Bulk Item # (10-pc)
#0	1/4"	1-15/16"	—	—	93235
#1	1/4"	1-15/16"	—	—	93237
#1	1/4"	2-3/4"	—	—	93245
#1	1/4"	3"	—	—	93253
#1	1/4"	6"	—	—	93263
#2	1/4"	1-15/16"	3522391C	3522395C	93239
#2	1/4"	2-3/4"	—	—	93247
#2	1/4"	3"	—	—	93255
#2	1/4"	6"	—	—	93265
#3	1/4"	1-15/16"	—	—	93241
#3	1/4"	2-3/4"	—	—	93249
#3	1/4"	3"	—	—	93257
#3	1/4"	6"	—	—	93267
Power Bit Set					
#1, #2 & #3	1/4"	1-15/16"	3522993C	—	—

Slotted Bits

Slotted Insert Bits



92047

- Used for common round-head, oval-head and flat-head fasteners.

Point Size	Shank Diameter	Overall Length	Carded Item # (1-pc)	Carded Item # (2-pc)	Bulk Item #
3-4	1/4"	1"	3511051C	—	92105 (25-pc)
3-4	5/16"	1-1/2"	—	—	92163 (10-pc)
4-5	1/4"	1-1/2"	—	—	92135 (10-pc)
4-5	5/16"	1-1/2"	—	—	92165 (10-pc)
6-8	1/4"	1"	3511111C	3511112C	92111 (25-pc)
6-8	1/4"	1-1/2"	—	—	92139 (10-pc)
6-8	5/16"	1-1/2"	—	—	92169 (10-pc)
8-10	1/4"	1"	3511131C	3511132C	92113 (25-pc)
8-10	1/4"	1-1/2"	—	—	92141 (10-pc)
8-10	5/16"	1-1/2"	—	—	92171 (10-pc)
10-12	1/4"	1"	3511151C	3511152C	92115 (25-pc)
10-12	1/4"	1-1/2"	—	—	92143 (10-pc)
10-12	5/16"	1-1/2"	—	—	92173 (10-pc)
12-14	1/4"	1"	—	—	92117 (25-pc)
12-14	1/4"	1-1/2"	—	—	92145ZR (10-pc)
12-14	5/16"	1-1/2"	—	—	92175 (10-pc)
14-16	1/4"	1"	—	—	92119 (25-pc)
14-16	1/4"	1-1/2"	—	—	92147 (10-pc)
14-16	5/16"	1-1/2"	—	—	92177ZR (10-pc)

Slotted Power Bits with Finder



93193

- Assists in keeping power bit engaged with fastener.

Point Size	Shank Diameter	Overall Length	Bulk Item # (10-pc)
4-5	1/4"	3-3/4"	93186
5-6	1/4"	2-5/32"	93191
5-6	1/4"	3-3/4"	93187
6-8	1/4"	2-5/32"	93193
6-8	1/4"	3-3/4"	93188
8-10	1/4"	3-3/4"	93189
10-12	1/4"	2-5/32"	93195

FASTENER DRIVE

Slotted Power Bits



93111

Point Size	Shank Diameter	Overall Length	Carded Item # (1-pc)	Bulk Item # (10-pc)
3-4	1/4"	2"	—	93103
3-4	1/4"	2-3/4"	—	93123
3-4	1/4"	3"	—	93139
3-4	1/4"	3-1/2"	—	93155
3-4	1/4"	6"	—	93173
4-5	1/4"	2"	—	93105ZR
4-5	1/4"	2-3/4"	—	93125
4-5	1/4"	3"	—	93141
4-5	1/4"	3-1/2"	—	93157
4-5	1/4"	6"	—	93175
5-6	1/4"	2"	3052010	93107
5-6	1/4"	2-3/4"	—	93127
5-6	1/4"	3"	—	93143
5-6	1/4"	3-1/2"	—	93159
5-6	1/4"	6"	—	93177
6-8	1/4"	2"	3521091C	93109
6-8	1/4"	2-3/4"	—	93129
6-8	1/4"	3"	—	93145
6-8	1/4"	3-1/2"	—	93161
6-8	1/4"	6"	—	93179
8-10	1/4"	2"	3521111C	93111
8-10	1/4"	2-3/4"	—	93131
8-10	1/4"	3"	—	93147
8-10	1/4"	3-1/2"	—	93163
8-10	1/4"	6"	—	93181
10-12	1/4"	2"	3521131C	93113ZR
10-12	1/4"	2-3/4"	—	93133
10-12	1/4"	3"	—	93149
10-12	1/4"	3-1/2"	—	93165
10-12	1/4"	6"	—	93183
12-14	1/4"	2"	—	93115
12-14	1/4"	2-3/4"	—	93135
12-14	1/4"	3"	—	93151
12-14	1/4"	3-1/2"	—	93167
12-14	1/4"	6"	—	93185
Power Bit Set				
4-5, 6-8 & 8-10	1/4"	2"		3523993C

FASTENER DRIVE



TORX® Bits

TORX Insert Bits



3522993C

Point Size	Shank Diameter	Overall Length	Carded Item # (1-pc)	Carded Item # (2-pc)	Carded Item # (10-pc)	Bulk Item # (10-pc)
T6	1/4"	1"	3053009	—	—	92306
T7	1/4"	1"	3513091C	—	—	92309
T8	1/4"	1"	3513121C	—	—	92312
T9	1/4"	1"	3513151C	—	—	92315
T10	1/4"	1"	3513181C	—	—	92318
T15	1/4"	1"	3513211C	—	—	92321
T20	1/4"	1"	3513241C	—	—	92324
T25	1/4"	1"	3513271C	—	351327XC	92327
T27	1/4"	1"	3513301C	—	—	92330
T30	1/4"	1"	3513331C	—	—	92333
T40	1/4"	1"	3513361C	—	—	92336
T30	5/16"	1-1/4"	—	—	—	92361
T40	5/16"	1-1/4"	—	—	—	92365
T45	5/16"	1-1/4"	—	—	—	92369
T50	5/16"	1-1/4"	—	—	—	92377
T55	5/16"	1-1/4"	—	—	—	92381
Insert Bit Sets						
T10 & T15	1/4"	1"	—	3514962C	—	—
T20 & T25	1/4"	1"	—	3514972C	—	—

FASTENER DRIVE



TORX Tamper-Resistant Bits

TORX Tamper-Resistant Insert Bits



92335

Point Size	Shank Diameter	Overall Length	Carded Item # (1-pc)	Carded Item # (6-pc)	Bulk Item #
T7	1/4"	1"	3053019	—	—
T8	1/4"	1"	3053021	—	—
T9	1/4"	1"	3053022	—	92317 (10-pc)
T10	1/4"	1"	3053023	—	92320 (10-pc)
T15	1/4"	1"	3053024	—	92323 (10-pc)
T20	1/4"	1"	3053025	—	92326 (10-pc)
T25	1/4"	1"	3053026	—	92329 (10-pc)
T27	1/4"	1"	3053027	—	92332 (10-pc)
T30	1/4"	1"	3053028	—	92335 (10-pc)
T40	1/4"	1"	3053029	—	92338 (10-pc)
T45	5/16"	1-1/4"	3053058	—	92371 (5-pc)
T50	5/16"	1-1/4"	3053059	—	92379 (5-pc)
T55	5/16"	1-1/4"	3043060	—	92383 (5-pc)
Insert Bit Set					
T10, T15, T20, T25, T27 & T30	1/4"	1"	—	3514996C	—



TORX® Bits

TORX Power Bits



93336

Point Size	Shank Diameter	Overall Length	Carded Item # (1-pc)	Carded Item # (3-pc)	Bulk Item # (5-pc)
T6	1/4"	2"	—	—	93306
T7	1/4"	2"	—	—	93309
T7	1/4"	2-3/4"	—	—	93337
T7	1/4"	3-1/2"	—	—	93356
T8	1/4"	2"	—	—	93312
T8	1/4"	2-3/4"	—	—	93339
T8	1/4"	3-1/2"	—	—	93357
T8	1/4"	6"	—	—	93366
T9	1/4"	2"	—	—	93315
T9	1/4"	2-3/4"	—	—	93340
T9	1/4"	3-1/2"	—	—	93358
T10	1/4"	2"	3523181C	—	93318
T10	1/4"	2-3/4"	—	—	93341
T10	1/4"	3-1/2"	—	—	93359
T10	1/4"	6"	3052018	—	93367
T15	1/4"	2"	3523211C	—	93321
T15	1/4"	2-3/4"	3052012	—	93342
T15	1/4"	3-1/2"	3052015	—	93360
T15	1/4"	6"	3052019	—	93368
T20	1/4"	2"	3523241C	—	93324
T20	1/4"	2-3/4"	3052013	—	93343
T20	1/4"	3-1/2"	3052016	—	93361
T20	1/4"	6"	3052020	—	93369
T25	1/4"	2"	3523271C	—	93327
T25	1/4"	2-3/4"	3052014	—	93344
T25	1/4"	3-1/2"	3052017	—	93362
T25	1/4"	6"	3052021	—	93370
T27	1/4"	2"	3523301C	—	93330
T27	1/4"	2-3/4"	—	—	93345
T27	1/4"	3-1/2"	—	—	93363
T27	1/4"	6"	—	—	93371
T30	1/4"	2"	3523331C	—	93333
T30	1/4"	2-3/4"	—	—	93346
T30	1/4"	3-1/2"	—	—	93364
T30	1/4"	6"	—	—	93372
T40	1/4"	2"	3052011	—	93336
T40	1/4"	2-3/4"	—	—	93347
T40	1/4"	3-1/2"	—	—	93365
T40	1/4"	6"	—	—	93373
Power Bit Set					
T15, T20 & T25	1/4"	1-15/16"	—	3524993C	

FASTENER DRIVE



POZIDRIV® Bits

POZIDRIV Insert Bits



92085

Point Size	Shank Diameter	Overall Length	Carded Item # (1-pc)	Bulk Item # (25-pc)
#1	1/4"	1"	3510831C	92083
#2	1/4"	1"	3510851C	92085
#3	1/4"	1"	3510871C	92087

POZIDRIV Power Bits



93079

Point Size	Shank Diameter	Overall Length	Carded Item # (1-pc)	Bulk Item # (10-pc)
#1	1/4"	2"		93073
#1	1/4"	3-1/2"	3052022	93036
#1	1/4"	6"	—	93039
#2	1/4"	2"	—	93077
#2	1/4"	3-1/2"	3052023	93037
#2	1/4"	6"	—	93040
#3	1/4"	2"	—	93079
#3	1/4"	3-1/2"	3052024	93038
#3	1/4"	6"		93041

FASTENER DRIVE



TORQ-SET® Bits

TORQ-SET Insert Bits



92238

Point Size	Shank Diameter	Overall Length	Carded Item # (2-pc)	Bulk Item # (5-pc)
#0	1/4"	1"	3053037	92230
#1	1/4"	1"	3053038	92231
#2	1/4"	1"	3053039	92232
#3	1/4"	1"	3053040	92233
#4	1/4"	1"	3053041	92234
#5	1/4"	1"	3053042	92235
#6	1/4"	1"	3053043	92236
#8	1/4"	1"	3053044	92238
#10	1/4"	1"	3053045	92240

TORQ-SET Power Bits



93438

Point Size	Shank Diameter	Overall Length	Carded Item # (2-pc)	Bulk Item # (5-pc)
#0	1/4"	1-1/4"	3052025	93430
#1	1/4"	1-1/4"	3052026	93431
#2	1/4"	1-1/4"	3052027	93432
#3	1/4"	1-1/4"	3052028	93433
#4	1/4"	1-1/4"	3052029	93434
#5	1/4"	1-1/4"	3052030	93435
#6	1/4"	1-1/4"	3052031	93436
#8	1/4"	1-1/4"	3052032	93438
#10	1/4"	1-1/4"	3052033	93439



Hex Head Bits

Hex Head Metric Insert Bits



92531

Point Size	Shank Diameter	Overall Length	Bulk Item # (10-pc)
2 mm	1/4"	1-1/4"	92507
3 mm	1/4"	1-1/4"	92509
3 mm	5/16"	1-1/4"	92525
4 mm	1/4"	1-1/4"	92511
4 mm	5/16"	1-1/4"	92527
5 mm	1/4"	1-1/4"	92513
5 mm	5/16"	1-1/4"	92529
6 mm	1/4"	1-1/4"	92515
6 mm	5/16"	1-1/4"	92531
8 mm	1/4"	1-1/4"	92517
8 mm	5/16"	1-1/4"	92533

Hex Head Fractional Insert Bits

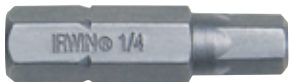

92495

Point Size	Shank Diameter	Overall Length	Carded Item # (1-pc)	Bulk Item # (10-pc)
.050"	1/4"	1-1/4"	—	92407
1/16"	1/4"	1-1/4"	—	92403
5/64"	1/4"	1-1/4"	3053010	92411
3/32"	1/4"	1-1/4"	3053011	92415
7/64"	1/4"	1-1/4"	3053012	92419
1/8"	1/4"	1-1/4"	3053013	92423
9/64"	1/4"	1-1/4"	3053014	92427
5/32"	1/4"	1-1/4"	3053015	92431
5/32"	5/16"	1-1/4"	—	92489
3/16"	1/4"	1-1/4"	3053016	92437
3/16"	5/16"	1-1/4"	—	92491
7/32"	1/4"	1-1/4"	3053017	92443
7/32"	5/16"	1-1/4"	—	92493
1/4"	1/4"	1-1/4"	3053018	92451
1/4"	5/16"	1-1/4"	—	92495
5/16"	1/4"	1-1/4"	—	92467
5/16"	5/16"	1-1/4"	—	92497
3/8"	1/4"	1-1/4"	—	92483
3/8"	5/16"	1-1/4"	—	92499

Insert Bit Set

3/32", 7/64", 1/8", 9/64", 5/32", 3/16" & 7/32" 1/4" 1-1/4" 3515997C (7-pc)

Hex Head Power Bits



93411

Point Size	Shank Diameter	Overall Length	Bulk Item # (10-pc)
1/16"	1/4"	1-15/16"	93403
5/64"	1/4"	1-15/16"	93405
3/32"	1/4"	1-15/16"	93407
7/64"	1/4"	1-15/16"	93409
1/8"	1/4"	1-15/16"	93411
9/64"	1/4"	1-15/16"	93413
5/32"	1/4"	1-15/16"	93415
3/16"	1/4"	1-15/16"	93419
7/32"	1/4"	1-15/16"	93423
1/4"	1/4"	1-15/16"	93427

FASTENER DRIVE

Frearson Bits

Frearson Insert Bits



92595

Shank Diameter	Overall Length	Bulk Item # (10-pc)
1/4"	1"	92595

Frearson Power Bits



93481

Shank Diameter	Overall Length	Bulk Item # (10-pc)
1/4"	2"	93481

Type A Clutch Insert Bits



92545

Point Size	Shank Diameter	Overall Length	Carded Item # (1-pc)	Bulk Item # (10-pc)
5/32"	1/4"	1"	3053047	92545
3/16"	1/4"	1"	3053048	92549

Type G Clutch Bits

Type G Clutch Insert Bits



92543

Point Size	Shank Diameter	Overall Length	Carded Item # (1-pc)	Bulk Item # (10-pc)
1/8"	1/4"	1"	3053049	92543
5/32"	1/4"	1"	3053050	92547
3/16"	1/4"	1"	3053051	92551

Type G Clutch Power Bits



93467

Point Size	Shank Diameter	Overall Length	Carded Item # (1-pc)	Bulk Item # (5-pc)
1/8"	1/4"	1-15/16"	3052034	93463
5/32"	1/4"	1-15/16"	3052035	93467
3/16"	1/4"	1-15/16"	3052036	93471
5/32"	1/4"	2-3/4"	3052037	93475

TRI-WING® Insert Bits



92536

Point Size	Shank Diameter	Overall Length	Carded Item # (2-pc)	Bulk Item # (5-pc)
#1	1/4"	1"	3053030	92535
#2	1/4"	1"	3053031	92536
#3	1/4"	1"	3053032	92537
#4	1/4"	1"	3053033	92538
#5	1/4"	1"	3053034	92539
#6	1/4"	1-1/4"	3053035	92540
#7	1/4"	1-1/4"	3053036	92599

FASTENER DRIVE



Spanner Insert Bits



92567

Point Size	Shank Diameter	Overall Length	Carded Item # (1-pc)	Bulk Item # (10-pc)
#4	1/4"	1"	3053052	92563
#6	1/4"	1"	3053053	92565
#8	1/4"	1"	3053054	92567
#10	1/4"	1"	3053055	92569
#12	1/4"	1"	3053056	92571
#14	1/4"	1"	3053057	92573

Double-End Bits*



93525

- Two screwdriver bits combined in a durable one-piece design for added convenience and versatility.

Point Size	Shank Diameter	Overall Length	Carded Item # (2-pc)	Bagged Item # (5-pc)	Bagged Item # (3-pc)	Bulk Item # (10-pc)
#1 Phillips®/6-8 Slotted	1/4"	1-1/2"	3054001	—	—	93503
#2 Phillips/8-10 Slotted	1/4"	1-1/2"	3535092C	3535095B	—	93509
#3 Phillips/10-12 Slotted	1/4"	1-1/2"	3054002	—	—	93515ZR
#1 Phillips/6-8 Slotted	1/4"	2-3/8"	—	—	—	93521
#2 Phillips/8-10 Slotted	1/4"	2-3/8"	3535252C	3535255B	—	93525
#2 Phillips/#2 Phillips	1/4"	2-3/8"	3532022C	3532025B	—	353202
#3 Phillips/10-12 Slotted	1/4"	2-3/8"	—	—	—	353201
#2 Sq Recess/#2 Sq Recess	1/4"	2-3/8"	—	3532035B	—	353203
#2 Phillips/8-10 Slotted	1/4"	3-1/2"	3533012C	—	—	—
Double End Bit Set						
#1 Phillips/6-8 Slotted, #2 Phillips/8-10 Slotted & #3 Phillips/10-12 Slotted	1/4"	2-3/8"	—	—	3532993C	—

* DO NOT place double-end bits in bit holding screwdrivers, power bit holders, or quick-change chuck adapters. The retaining ring in the bit holder is designed for insert bits only.

FASTENER DRIVE

Ceiling Tile Hanger Bits



93543

- Unique shape allows for faster driving of eye hooks from which ceiling grids are hung.

Description	Overall Length	Bulk Item # (25-pc)
1/4" Ceiling Tile Hanger Bit	3"	93543
5/16" Ceiling Tile Hanger Bit	3"	93545

Screw Guides — Retracting Sleeves



93551

- Engineered for use with long fasteners and/or hard-to-reach applications. Screw-guide sleeve retracts as the fastener is driven into the workpiece.
- Reduces slipping and wobbling of fasteners.
- Rare earth magnet holds fastener securely. Magnet is four times more powerful than standard magnets.

Hex Drive	Shank Diameter	Retracted Length	Extended Length	Carded Item # (1-pc)	Bulk Item # (5-pc)
Compact	1/4"	3-1/16"	4-11/16"	3555511C	93551
Standard	1/4"	4-11/16"	7-3/8"	3555531C	93553

Insert Bit Holders

IRWIN® offers an extensive selection of insert bit holders for use with socket wrenches or adapters. Some types are available with a c-ring design that holds bits securely in place. Others hold bits with powerful rare earth magnets. IRWIN's bit holders are offered in a variety of shank sizes and types including 1/4" hex shanks, 7/16" hex shanks, and square.

Features

- C-ring design has internal clip that fits into the retaining ring notch of the insert bit to hold bit securely in place.*
- Rare earth magnet holds fastener securely. Magnet is four times more powerful than standard magnets.**

1/4" Hex Shank Bit Holders



93718

Point Size	Overall Length	Carded Item # (1-pc)	Bagged Item # (3-pc)	Bulk Item # (10-pc)
Standard with C-Ring	2-1/4"	—	—	93711
Standard with C-Ring	2-1/4"	3557121C	3557123B	93712
No C-Ring	2-1/4"	—	—	93714
Knurled	3"	3056002	—	93715
Standard with C-Ring	3"	—	—	93717
Standard with C-Ring	3"	3557181C	3557183B	93718
Turned	3"	—	—	93720
Turned	3"	—	—	93721
No C-Ring	3"	—	—	93722
Standard with C-Ring	4"	—	—	93728
Standard with C-Ring	6"	—	—	93730
Standard with C-Ring	8"	—	—	93732
Standard with C-Ring	10"	—	—	93734
Standard with C-Ring	12"	—	—	93736

1/4" Hex Shank Bit Holders For 5/16" Hex Insert Bits



93724

Hex Drive	Overall Length	Bulk Item # (10-pc)
Turned	3"	93723
Turned	3"	93724

*C-Ring design only

**Magnetic bit holders only

FASTENER DRIVE

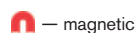

7/16" Hex Shank Bit Holders



93741

Hex Drive	Overall Length	Bulk Item # (10-pc)
For 1/4" Insert Bits	2-3/4"	93741

Square Drive Bit Holders



93813

Square Drive	Bit Size	Overall Length	Carded Item # (1-pc)	Bagged Item # (3-pc)	Bulk Item #
	1/4"	1"	3056003	—	93811 (10-pc)
Ⓜ	1/4"	1"	4935070	—	4935072 (10-pc)
	3/8"	1-1/4"	3558131C	3558133B	93813 (10-pc)
Ⓜ	3/8"	1-1/4"	4935071	—	4935073 (10-pc)
	3/8"	5/16"	—	—	93815 (10-pc)
Ⓜ	3/8"	5/16"	—	—	4935074 (10-pc)
	1/2"	1-1/2"	3056005	—	93817 (5-pc)
Ⓜ	1/2"	5/16"	—	—	4935075 (10-pc)

Lobular Nutsetters



IRWIN® lobular nutsetters are designed to drive the fastener from the side, rather than forcing the corners to turn, maintaining the true shape of the fastener and dramatically reducing breakage and damage from stripping. The lobular design also provides more clearance on the corners of the fastener where paint build-up often occurs. They are manufactured with powerful rare earth magnets that hold fasteners securely in place, and a 1/4" quick-change shank that works in all types of drills and drivers.



Fractional Nutsetter 1-7/8" Length – Lobular



94712

Hex Drive	Shank Diameter	Socket Body Dia.	Carded Item #	Bagged Item # (3-pc)	Bulk Item # (10-pc)	
Ⓜ	1/4"	1/4"	7/16"	3547121C	3547123B	94712
Ⓜ	5/16"	1/4"	1/2"	3547321C	3547323B	94732
Ⓜ	3/8"	1/4"	9/16"	3547521C	3547523B	94752
Ⓜ	7/16"	1/4"	5/8"	3547721C	3547723B	94772

Fractional Nutsetter 2-9/16" Length – Lobular



94872

Hex Drive	Shank Diameter	Socket Body Dia.	Carded Item # (1-pc)	Bagged Item # (2-pc)	Bagged Item # (3-pc)	Bulk Item # (10-pc)	
Ⓜ	1/4"	1/4"	7/16"	3548121C	3548122B	3548123B	94812
Ⓜ	5/16"	1/4"	1/2"	3548321C	3548322B	3548323B	94832
Ⓜ	3/8"	1/4"	9/16"	3548521C	—	3548523B	94852
Ⓜ	7/16"	1/4"	5/8"	3548721C	—	3548723B	94872

Nutsetter Sets – Lobular



3545984C

Hex Drive	Shank Diameter	Overall Length	Carded Item # (3-pc)	Carded Item # (4-pc)	
Ⓜ	1/4", 5/16", 3/8"	1/4"	1-7/8"	3545973C	—
Ⓜ	1/4", 5/16", 3/8", 7/16"	1/4"	1-7/8"	—	3545984C
Ⓜ	1/4", 5/16", 3/8"	1/4"	2-9/16"	3545993C	—

Ⓜ — magnetic

FASTENER DRIVE

Nutsetters

Metric Nutsetters



94204

- Magnetic nutsetters use rare earth magnetics that are 4X more powerful than common magnets.

Hex Drive	Shank Diameter	Socket Body Dia.	Overall Length	Bagged Item # (3-pc)	Bulk Item # (10-pc)
6 mm	1/4"	11.1 mm	47.6 mm	3051019	94202
8 mm	1/4"	12.7 mm	47.6 mm		94203
8 mm	1/4"	12.7 mm	47.6 mm	3051020	94204ZR
10 mm	1/4"	14.3 mm	47.6 mm	3051021	94206

Magnetic Insert Nutsetters



94132

- Can be used in bit holding screwdrivers or in any non-magnetic bit holders.

Hex Drive	Shank Diameter	Socket Body Dia.	Overall Length	Bulk Item # (10-pc)
1/4"	1/4"	7/16"	1-1/2"	94112ZR
5/16"	1/4"	1/2"	1-1/2"	94132
3/8"	1/4"	9/16"	1-5/8"	94152
7/16"	1/4"	5/8"	1-5/8"	94172ZR

Fractional Nutsetters



94212

- For use with sheet metal screws and other hexagonal head fasteners.

Hex Drive	Shank Body	Shank Diameter	Socket Body Dia.	Overall Length	Carded Item # (1-pc)	Bagged Item # (3-pc)	Bulk Item # (10-pc)
3/16"	—	1/4"	7/16"	1-7/8"	—	3051010	94209
1/4"	—	1/4"	7/16"	1-7/8"	—	—	94211
1/4"	—	1/4"	7/16"	1-7/8"	—	3051011	94212
1/4"	—	1/4"	1/2"	1-7/8"	—	—	94215
1/4"	—	1/4"	1/2"	1-7/8"	—	—	94216
1/4"	—	1/4"	7/16"	2-9/16"	—	—	94311
1/4"	—	1/4"	7/16"	2-9/16"	—	3051012	94312
1/4"	3/8"	1/4"	7/16"	2-9/16"	—	—	94316
1/4"	—	1/4"	7/16"	4"	3051001	—	94414
1/4"	—	1/4"	7/16"	6"	3051004	—	94416
1/4"	—	1/4"	7/16"	12"	3051007	—	—
5/16"	—	1/4"	1/2"	1-7/8"	—	—	94231
5/16"	—	1/4"	1/2"	1-7/8"	—	3051013	94232
5/16"	5/16"	1/4"	1/2"	2-9/16"	—	—	94331ZR
5/16"	5/16"	1/4"	1/2"	2-9/16"	—	3051014	94332
5/16"	3/8"	1/4"	1/2"	2-9/16"	—	—	94335
5/16"	3/8"	1/4"	1/2"	2-9/16"	—	—	94336
5/16"	—	1/4"	1/2"	4"	3051002	—	94434
5/16"	—	1/4"	1/2"	6"	3051005	—	94436
5/16"	—	1/4"	1/2"	12"	3051008	—	—
3/8"	—	1/4"	9/16"	1-7/8"	—	—	94251ZR
3/8"	—	1/4"	9/16"	1-7/8"	—	3051015	94252
3/8"	5/16"	1/4"	9/16"	2-9/16"	—	—	94351
3/8"	5/16"	1/4"	9/16"	2-9/16"	—	3051016	94352
3/8"	3/8"	1/4"	9/16"	2-9/16"	—	—	94356ZR
3/8"	—	1/4"	9/16"	4"	3051003	—	—
3/8"	—	1/4"	9/16"	6"	3051006	—	—
3/8"	—	1/4"	9/16"	12"	3051009	—	—
7/16"	—	1/4"	5/8"	1-7/8"	—	—	94271
7/16"	—	1/4"	5/8"	1-7/8"	—	—	94272
7/16"	3/8"	1/4"	5/8"	2-9/16"	—	—	94371ZR
7/16"	3/8"	1/4"	5/8"	2-9/16"	—	3051017	94372ZR
1/2"	—	1/4"	3/4"	1-7/8"	—	—	94291
1/2"	—	1/4"	3/4"	2-9/16"	—	3051018	—

— magnetic

— tapered

Socket Adapters

IRWIN® socket adapters are available with a pin-lock design that's best for production applications, or a ball-lock retention design for applications when quick-change is ideal. The body of the socket is forged for additional strength.

7/16" Hex Shank Square Drive Socket Adapter



93749

Square Drive	Lock Type	Overall Length	Bulk Item # (5-pc)
3/8"	Pin	5"	93748
1/2"	Pin	3"	93749

1/4" Square Drive Socket Adapter



93758

Square Drive	Lock Type	Overall Length	Carded Item # (1-pc)	Bulk Item # (10-pc)
1/4"	Pin	1-3/8"	3056004	93755
1/4"	Ball	1-3/8"	—	93756
1/4"	Pin	2"	—	93758
1/4"	Ball	2"	3567611C	93761
1/4"	Pin	3"	—	93763
1/4"	Ball	3"	—	93765
1/4"	Pin	4"	—	93771
1/4"	Pin	6"	—	93776
1/4"	Ball	6"	—	93777

3/8" Square Drive Socket Adapter



93783

Square Drive	Lock Type	Overall Length	Carded Item # (1-pc)	Bulk Item # (10-pc)
3/8"	Pin	1-5/8"	—	93781
3/8"	Ball	1-5/8"	—	93782
3/8"	Pin	2"	—	93783
3/8"	Ball	2"	3567841C	93784
3/8"	Pin	3"	—	93786
3/8"	Ball	3"	—	93787
3/8"	Pin	4"	—	93789
3/8"	Pin	6"	—	93792
3/8"	Ball	6"	—	93793

1/2" Square Drive Socket Adapter



93795

Square Drive	Lock Type	Overall Length	Carded Item # (1-pc)	Bulk Item #
1/2"	Ball	2"	3567951C	93795 (10-pc)
1/2"	Ball	3"	—	93797 (5-pc)

FASTENER DRIVE

Fastener Drive & Screwdriving

Sets

20-piece IRWIN® PRO-PAK™



357320

Contents	PRO-PAK™ Item #
#2 Phillips® Insert Bit 1"	357320
#2 Phillips Drywall Insert Bit 1"	357120
#2 Square Recess Insert Bit 1"	357220
#2 Square 2-pc Insert Bit 1"	357220C

7-piece Drive Guide Set



3057011DS

Contents	Quantity	Item # 3057011DS
#2 Phillips Insert Bit 1"	2	92011
#2 Square Recess Insert Bit 1"	2	92205
8-10 Slotted Insert Bits 1"	2	92113
Compact Magnetic Drive Guide	1	93551

13-piece Drive Guide Set



3057013DS

Contents	Quantity	Item # 3057013DS
#1 Phillips Insert Bit 1"	1	92005
#2 Phillips Insert Bit 1"	4	92011
#3 Phillips Insert Bit 1"	1	92019
#1 Square Recess Insert Bit 1"	1	92203
#2 Square Recess Insert Bit 1"	3	92205
8-10 Slotted Insert Bit 1"	2	92113
4-11/16" Magnetic Drive Guide	1	93553

21-piece Drive Guide Set



3057002DS

Contents	Quantity	Item # 3057002DS
#2 Phillips Insert Bits 1"	10	92011
#2 Square Insert Bits 1"	5	92205
8-10 Slotted Insert Bits 1"	5	92113
4-11/16" Magnetic Drive Guide	1	93553

FASTENER DRIVE

 — magnetic

7-piece Quick-Change Bit Set



3057003DS

Contents	Quantity	Item # 3057003DS
#1 Phillips Power Bit 2"	1	93003
#2 Phillips Power Bit 2"	2	93007
#2 Square Recess Power Bit 2"	2	93205
8-10 Slotted Power Bit 2"	1	93111
2-1/2" Quick-Change Chuck	1	90102

31-piece Screwdriver Bit Set with Storage



3057026

- Includes soft case with snap-lock closure and durable hinge for rigorous jobsite conditions.
- Bit and fastener storage case included.

Contents	Quantity	Item # 3057026
 Magnetic Bit Holder 2-1/4"	1	93714
#1 Phillips Insert Bit 1"	2	92005
#2 Phillips Insert Bit 1"	5	92011
#3 Phillips Insert Bit 1"	3	92019
#1 Square Recess Insert Bit 1"	2	92203
#2 Square Recess Insert Bit 1"	5	92205
#3 Square Recess Insert Bit 1"	1	92207
4-5 Slotted Insert Bit 1"	1	92107
6-8 Slotted Insert Bit 1"	3	92111
8-10 Slotted Insert Bit 1"	2	92113
10-12 Slotted Insert Bit 1"	1	92115
T15 Torx® Insert Bit 1"	1	92321
T20 Torx Insert Bit 1"	1	92324
T25 Torx Insert Bit 1"	1	92327
T27 Torx Insert Bit 1"	1	92330
T30 Torx Insert Bit 1"	1	92333

FASTENER DRIVE

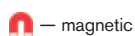

31-piece SPEEDBOR® Drill/Drive Set



3057031

- Includes soft case with snap-lock closure and durable hinge for rigorous jobsite conditions.

Contents	Quantity	Item # 3057031
2-1/2" Quick-Change Chuck	1	90102
Magnetic Bit Holder 2-1/4"	1	93714
Compact Magnetic Screw Guide 3-1/16"	1	93551
#1 Phillips® Power Bit 2"	2	93003
#2 Phillips Power Bit 2"	4	93007
#3 Phillips Power Bit 2"	1	93011
8-10 Slotted Power Bit 2"	1	93111
10-12 Slotted Power Bit 2"	1	93113
#1 Square Recess Power Bit 2"	2	93203
#2 Square Recess Power Bit 2"	3	93205
#3 Square Recess Power Bit 2"	1	93207
#2 Square Recess Power Bit 1"	3	92205
#2 Phillips Insert Bit 1"	4	92011
3/8"-6" SPEEDBOR Drill Bit	1	99906
1/2"-6" SPEEDBOR Drill Bit	1	99908
5/8"-6" SPEEDBOR Drill Bit	1	99910
3/4"-6" SPEEDBOR Drill Bit	1	99912
7/8"-6" SPEEDBOR Drill Bit	1	99914
1"-6" SPEEDBOR Drill Bit	1	99916

41-piece Screwdriver Bit Soft Case Set



3057041

- Includes soft case with snap-lock closure and durable hinge for rigorous jobsite conditions.

Contents	Quantity	Item # 3057041
Compact Magnetic Screw Guide 3-1/16"	1	93551
Magnetic Bit Holder 2-1/4"	1	93714
#1 Phillips Insert Bit 1"	2	92005
#2 Phillips Insert Bit 1"	6	92011
#3 Phillips Insert Bit 1"	2	92019
#1 Square Recess Insert Bit 1"	2	92203
#2 Square Recess Insert Bit 1"	4	92205
#3 Square Recess Insert Bit 1"	1	92207
6-8 Slotted Insert Bit 1"	1	92111
8-10 Slotted Insert Bit 1"	2	92113
10-12 Slotted Insert Bit 1"	1	92115
#1 Phillips Power Bit 2"	1	93003
#2 Phillips Power Bit 2"	4	93007
#3 Phillips Power Bit 2"	2	93003
8-10 Slotted Power Bit 2"	1	93111
10-12 Slotted Power Bit 2"	1	93113
#1 Square Recess Power Bit 2"	1	93203
#2 Square Recess Power Bit 2"	3	93205
#3 Square Recess Power Bit 2"	1	93207
#2 Phillips Power Bit 4"	1	93059
#2 Square Recess Power Bit 4"	1	93226
1/4" - 1-7/8" Nutsetter	1	94712
5/16" - 1-7/8" Nutsetter	1	94732

FASTENER DRIVE

Pro Set Cases

IRWIN® professional fastener drive sets have convenient molded plastic cases that hold up anything the jobsite can throw at them.

Pro Set Cases

FEATURES

1. Two-step easy in/out bit storage holds bits securely in place until ready for use.
2. Molded plastic case holds up to rigors of daily use.
3. Full-length metal pin in hinge for added durability and life.

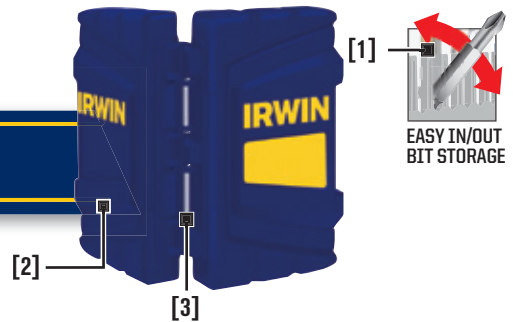

16-piece Screwdriver Bit Set

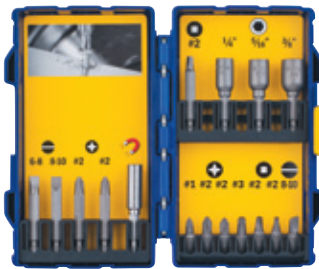

3057014

Contents	Quantity	Item # 3057014
Magnetic Bit Holder 2-1/4"	1	97314
#1 Phillips® Insert Bit 1"	1	92005
#2 Phillips Insert Bit 1"	2	92011
#3 Phillips Insert Bit 1"	1	92019
#2 Square Recess Insert Bit 1"	2	92205
8-10 Slotted Insert Bit 1"	1	92113
1/4" x 1-7/8" Nutsetter	1	94712
5/16" x 1-1/8" Nutsetter	1	94732
3/8" x 1-7/8" Nutsetter	1	94752
#2 Phillips Power Bit 2"	2	93007
#2 Square Recess Insert Bit 2"	1	93205
8-10 Slotted Power Bit 2"	1	93111
6-8 Slotted Power Bit 2"	1	93109

24-piece Screwdriver Bit Set



3057015

Contents	Quantity	Item # 3057015
#1 Phillips Insert Bit 1"	1	92005
#2 Phillips Insert Bit 1"	5	92011
#3 Phillips Insert Bit 1"	1	92019
#1 Square Recess Insert Bit 1"	1	92203
#2 Square Recess Insert Bit 1"	3	92205
#3 Square Recess Insert Bit 1"	2	92207
8-10 Slotted Insert Bit 1"	1	92113
Compact Magnetic Screw Guide 3-1/16"	1	93551
1/4" x 1-7/8" Nutsetter	1	94712
5/16" x 1-1/8" Nutsetter	1	94732
3/8" x 1-7/8" Nutsetter	1	94752
#2 Phillips Power Bit 4"	1	93057
#2 Square Recess Insert Bit 4"	1	93226
#2 Phillips Power Bit 2"	2	93007
#2 Square Recess Power Bit 2"	1	93205
8-10 Slotted Power Bit 2"	1	93111

— magnetic

FASTENER DRIVE

20-piece Drill / Drive Set



357020

Contents	Quantity	Item # 357020
Compact Magnetic Drive Guide	1	93551
1/4" x 2-9/16" Nutsetter	1	94812
3/8" x 2-9/16" Nutsetter	1	94852
5/16" x 2-9/16" Nutsetter	1	94832
#2/#2 Phillips Double End Bit	1	353202
#1 Phillips Insert Bit	1	92005
#2 Phillips Insert Bit	2	92011
#3 Phillips Insert Bit	1	92019
#2 Square Recess Insert Bit	2	92205
8-10 Slotted Insert Bit	1	92113
1/4" 135° Black Oxide HSS Fractional Straight Shank Jobber Length Drill Bit	1	63516
3/16" 135° Black Oxide HSS Fractional Straight Shank Jobber Length Drill Bit	1	63512
5/32" 135° Black Oxide HSS Fractional Straight Shank Jobber Length Drill Bit	1	63510
1/8" 135° Black Oxide HSS Fractional Straight Shank Jobber Length Drill Bit	2	63508
3/32" 135° Black Oxide HSS Fractional Straight Shank Jobber Length Drill Bit	1	63506
1/16" 135° Black Oxide HSS Fractional Straight Shank Jobber Length Drill Bit	2	63504

33-piece Screwdriver Bit Set

FASTENER DRIVE

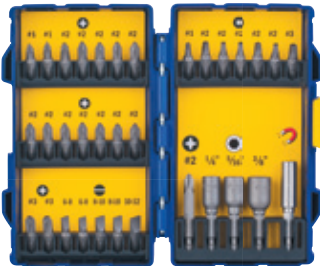

3057017

Contents	Quantity	Item # 3057017
Magnetic Bit Holder 2-1/4"	1	93714
#1 Phillips® Insert Bit 1"	2	92005
#2 Phillips Insert Bit 1"	12	92011
#3 Phillips Insert Bit 1"	2	92019
#1 Square Recess Insert Bit 1"	1	92203
#2 Square Recess Insert Bit 1"	5	92205
#3 Square Recess Insert Bit 1"	1	92207
1/4" x 1-7/8" Nutsetter	1	94712
5/16" x 1-7/8" Nutsetter	1	94732
3/8" x 1-7/8" Nutsetter	1	94752
#2 Phillips Power Bit 2"	1	93007
6-8 Slotted Insert Bit 1"	2	92111
8-10 Slotted Insert Bit 1"	2	92113
10-12 Slotted Insert Bit 1"	1	92115

40-piece Screwdriver Bit Set



3057018

Contents	Quantity	Item # 3057018
Magnetic Bit Holder 2-1/4"	1	93714
#1 Phillips Insert Bit 1"	2	92005
#2 Phillips Insert Bit 1"	7	92011
#3 Phillips Insert Bit 1"	2	92019
#1 Square Recess Insert Bit 1"	1	92203
#2 Square Recess Insert Bit 1"	5	92205
#3 Square Recess Insert Bit 1"	1	92207
6-8 Slotted Insert Bit 1"	1	92111
8-10 Slotted Insert Bit 1"	1	92113
10-12 Slotted Insert Bit 1"	1	92115
TORX® Insert Bits 1": T10, T15, T20, T25, T27, T30, T40	7	92318, 92321, 92324, 92327, 92330, 92333, 92336
Hex Head Insert Bits: 3/32", 7/64", 1/8", 9/64", 5/32", 3/16", 7/32"	7	92415, 92419, 92423, 92427, 92431, 92437, 92493
#2 Square Recess Power Bit 2"	1	93205
#3 Square Recess Power Bit 2"	1	93207
#2 Phillips Power Bit 2"	1	93007
#3 Phillips Power Bit 2"	1	93003

— magnetic

30-piece Screwdriver Set

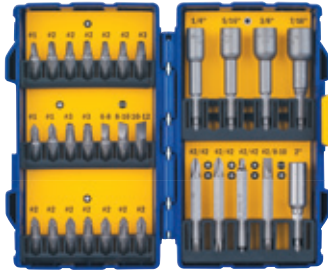

357030

Contents	Quantity	Item # 357030
#1 Phillips Insert Bit	2	92005
#2 Phillips Insert Bit	7	92011
#3 Phillips Insert Bit	2	92019
#1 Square Recess Insert Bit	1	92203
#2 Square Recess Insert Bit	5	92205
#3 Square Recess Insert Bit	1	92207
6-8 Slotted Insert Bit	1	92111
8-10 Slotted Insert Bit	1	92113
10-12 Slotted Insert Bit	1	92115
2-1/4" Magnetic Bit Holder	1	93712
#2/#2 Phillips Double End Bit	2	353202
#2 Sq Recess Double End	1	353203
8-10 Slotted Double End Bit	1	93525
1/4" Magnetic Nutsetters - 2-9/16"	1	94812
5/16" Magnetic Nutsetters - 2-9/16"	1	94832
3/8" Magnetic Nutsetters - 2-9/16"	1	94852
7/16" Magnetic Nutsetters - 2-9/16"	1	94872

16-piece Automotive & Maintenance Power Bit Set



3057016

Contents	Quantity	Item # 3057016
#2 Phillips® Power Bit x 3-1/2"	1	93025
#3 Phillips Power Bit x 3-1/2"	1	93029
#2 POZIDRIV® Power Bit x 3-1/2"	1	93037
#1 Phillips Power Bit x 6"	1	93063
#2 Phillips Power Bit x 6"	1	93067
T15 TORX® #2 Power Bit x 3-1/2"	1	93360
T20 TORX #2 Power Bit x 3-1/2"	1	93361
T20 TORX #2 Power Bit x 6"	1	93369
T25 TORX #2 Power Bit x 6"	1	93370
T27 TORX #2 Power Bit x 6"	1	93371
T30 TORX #2 Power Bit x 6"	1	93372
1/4" Socket Adapter x 2"	1	93761
3/8" Socket Adapter x 2"	1	93784
5/16" Magnetic Nutsetter x 1-7/8"	1	94732
2" Quick-Change Bit Holder	1	4935703
6" Quick-Change Bit Holder	1	4935704



FASTENER DRIVE

34-piece Automotive & Maintenance Power Bit Set



3057034



FASTENER DRIVE

Contents	Quantity	Item # 3057034
#1 Phillips Power Bit x 2"	1	93003
#2 Phillips Power Bit x 2"	1	93007
#3 Phillips Power Bit x 2"	1	93011
#1 POZIDRIV Power Bit x 2"	1	93073
#2 POZIDRIV Power Bit x 2"	1	93077
#3 POZIDRIV Power Bit x 2"	1	93079
T8 TORX Power Bit x 2"	1	93312
T9 TORX Power Bit x 2"	1	93315
T10 TORX Power Bit x 2"	1	93318
#1 Phillips Power Bit x 3-1/2"	1	93023
#2 Phillips Power Bit x 3-1/2"	1	93025
#3 Phillips Power Bit x 3-1/2"	1	93029
#2 POZIDRIV Power Bit x 3-1/2"	1	93037
T15 TORX Power Bit x 3-1/2"	1	93360
T20 TORX Power Bit x 3-1/2"	1	93361
T25 TORX Power Bit x 3-1/2"	1	93362
T30 TORX Power Bit x 3-1/2"	1	93364
#1 Phillips Power Bit x 6"	1	93063
#2 Phillips Power Bit x 6"	1	93067
#3 Phillips Power Bit x 6"	1	93069
#2 POZIDRIV Power Bit x 6"	1	93040
T15 TORX Power Bit x 6"	1	93368
T20 TORX Power Bit x 6"	1	93369
T25 TORX Power Bit x 6"	1	93370
T27 TORX Power Bit x 6"	1	93371
T30 TORX Power Bit x 6"	1	93372
1/4" Socket Adapter x 2"	1	93761
3/8" Socket Adapter x 2"	1	93784
1/2" Socket Adapter x 2"	1	93795
 1/2" Magnetic Nutsetter x 1-7/8"	1	94712
 5/16" Magnetic Nutsetter x 1-7/8"	1	94732
 3/8" Magnetic Nutsetter x 1-7/8"	1	94752
2" Quick-Change Bit Holder	1	4935703
6" Quick-Change Bit Holder	1	4935704

150-piece Screwdriving Bit Assortment



4935104

Contents	Quantity	Item # 4935104
#1 Phillips Insert Bit 1/4" x 1"	10	92005
#2 Phillips Insert Bit 1/4" x 1"	15	92011
#3 Phillips Insert Bit 1/4" x 1"	10	92019
#2 Square Recess Insert Bit x 1"	15	92205
T20-TR Insert Bit x 1"	10	92326
T25-TR Insert Bit x 1"	15	92329
T27-TR Insert Bit x 1"	10	92332
8-10 Slotted Insert Bit x 1"	15	92113
#2 Phillips Power Bit - 1-15/16"	10	93007
#2 Square Recess Power Bit - 1-15/16"	10	93205
T25 Power Bit x 1-15/16"	10	93327
8 - 10 Slotted Power Bit x 1-15/16"	10	93111
 Nutsetter 1/4" x 1-7/8" Magnetic 3/Bag	3	3051011
 Nutsetter 5/16" x 1-7/8" Magnetic 3/Bag	3	3051013
 Nutsetter 3/8" x 1-7/8" Magnetic 3/Bag	3	3051015
 Bit Holder 2-31/32" Magnetic w/C-Ring 3/Bag	1	3557183B

 — magnetic

IRWIN 9-in-1™ Multi-Tool

IRWIN's 9-in-1 Multi-Tool takes versatility and convenience to a new level. This professional-grade tool features six (6) bits and three (3) nut drivers — the most common sizes — all conveniently stored inside the tool in a unique stacking configuration, so the right fastening tool will always be at your fingertips. The 9-in-1 Multi-Tool also features IRWIN's ergonomic ProTouch™ Grip, providing comfort and slip resistance for maximum torque.

9-in-1 MULTI-TOOL

FEATURES



2051100



3 Nut Setters

6 Bits



1 Nutsetter

7 Bits

FASTENER DRIVE

1. Nine (9) bits and nutsetters for use on a variety of fasteners.
2. Internal storage keeps bits and nutsetters locked in place and close at hand.
3. Ergonomic ProTouch™ grip provides maximum torque, comfort, and slip resistance.

IRWIN 8-in-1™ Multi-Tool

The highly versatile IRWIN 8-in-1 Multi-tool is ideal for hard-to-reach areas. This professional-grade tool includes seven (7) of the most common-sized screwdriving bits, all conveniently stored inside of the tool. The shank functions as a 1/4" nut driver. Plus, the shank is magnetic, so bits are held securely in place. The IRWIN 8-in-1 Multi-tool features a non-slip ProTouch™ Grip, providing maximum torque, with incredible comfort and control.

8-in-1 MULTI-TOOL

FEATURES



4935586

1. Magnetic shank holds bits securely in place.
2. Internal storage keeps bits locked in place and close at hand.
3. Ergonomic ProTouch™ grip provides maximum torque, comfort, and slip resistance.

Description	Item #	Carton Qty
9-in-1 Multi-Tool		
9-in-1 Multi-Tool	2051100	6
8-in 1 Multi-Tool		
8-in-1 Multi-Tool	4935586	5

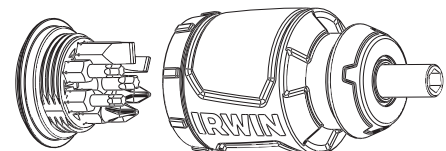

IRWIN[®]
TOOLS

WISE-GRIP *MARATHON* **QUICK-GRIP** *SPEEDBOR* STRAIT-LINE Marples *Unibit* **HANSON**