

Lumination® LED Luminaires

LRX Series | LED Downlights

Project name _____

Date _____

Type _____

Product Description:

The Lumination® LRX Series LED downlights are the ideal retrofit solution for traditional downlight fixtures. They install in just minutes into most 4-inch, 6-inch, 8-inch, 10-inch, and 12-inch rough-in frames and bring a fresh look to the space. Unlike plug-in LED lamps, the LRX downlight gives you a new power supply and 50,000 hour life rating, so that you won't have to worry about compatibility or maintenance issues with the original ballasts. All downlights in the LRX family utilize a non-conductive polycarbonate trim perfect for wet rated applications. The LRX can also be used for new construction applications (see Installation Guide for more information).



- Input Voltage:** 120 - 277V, 120V (Phase Dimming)
- Standard Dimming Controls:** 0-10V down to 10%, Forward Phase Dim to 10%
- CCT:** 3000K, 3500K, 4000K (other CCTs available, see ordering notes)
- CRI:** 82 (90 available, see ordering notes)
- Lifetime Rating:** L85 @ 50,000 Hours
- Input Frequency (Hz):** 50/60Hz
- Power Factor:** >0.9
- Mounting Options:** Spring clips clamp on to existing frame
- Weight:** Up to 4.6lb (weight may vary depending on size).
- IC Rating:** Non-IC Rated
- Limited Warranty:** 5 years system
- Operating Temperature:** -10°C to +40°C (no EMBB)
0°C to +25°C (with EMBB)
- Files Available:** LM79, LM80, IES

Listings:  • UL and cUL Listed.
• Suitable for wet locations, indoor covered ceilings only



Ordering Information:

8

PRODUCT FAMILY	SHAPE/SIZE	LUMENS	CRI	CCT	DIMMING	OPTIONS
LRX = Lumination® RX Series Downlight	R4 = 4" Round Retrofit Downlight S4 = 4" Square Retrofit Downlight	10 ¹ = 1000lm/650lm	8 = 82 CRI For additional CRI and CCT options see ordering note 6.	30 = 3000K 35 = 3500K 40 = 4000K	MD = 0-10V Dimming PH ^{3,6} = 120V Forward Phase Dimmable	BLANK = None EL ⁴ = EMBB Ready
	R6 = 6" Round Retrofit Downlight S6 = 6" Square Retrofit Downlight	10 ¹ = 1000lm/650lm 18 = 1800lm				
	R8 = 8" Round Retrofit Downlight S8 = 8" Square Retrofit Downlight	10 ¹ = 1000lm/650lm 18 = 1800lm 30 ⁸ = 3000lm 40 ² = 4000lm/3000lm				
	R10 ⁸ = 10" Round Retrofit Downlight	30 ⁸ = 3000lm 60 ⁸ = 4000/5000/6000lm				
	R12 ⁸ = 12" Round Retrofit Downlight	60 ⁸ = 4000/5000/6000lm				

Additional Ordering Notes:

1. 1000lm/650lm models feature a selectable lumen package to allow field adjustments to light output. See page 7 for details.
2. 4000lm/3000lm model only available with phase dimming.
3. Forward Phase Dimming available in Round and Square Shapes for 4000lm or lower in 8inch or small sizes.
4. Must order "EL" option + LRXEMBBKIT (sold separately) for complete EMBB solution. EL not available for 10inch or 12inch.
5. The standard trim is white. Colored trim options are available, see page 4 for details.
6. MTO Products: 90 CRI in 6" and 8" for 27K and 3K only; Additional CCTs of 2700K and 5000K; PH Dimming Option in SQUARE shape. Check manufacturer for lead time and minimum order quantities quote.
7. Attach to existing frame or install with new frame kit (ordered separately) per UL.
8. 10inch and 12inch 3000lm & 4000/5000/6000lm only for MD=0-10V dimming.

Product Dimensions: Lumination® LRX Series

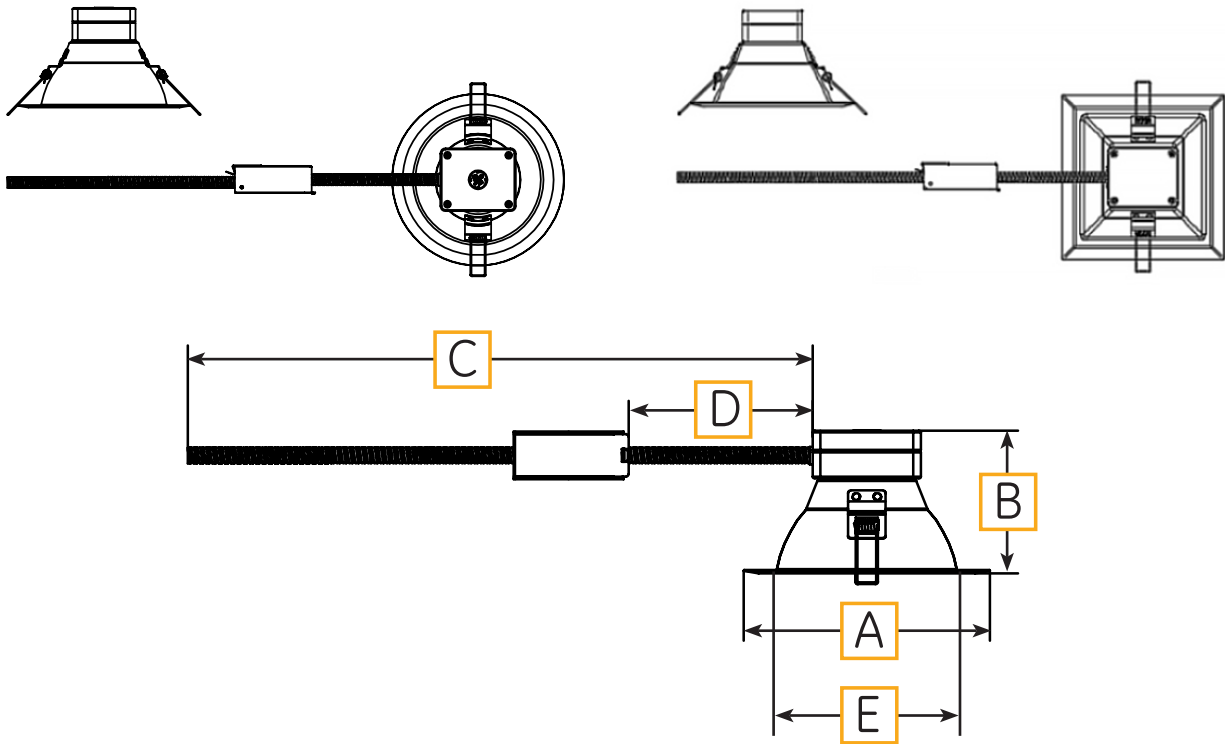

Square Shape

4-inch:

A = 5.75" (146 mm)
 B = 3.74" (95 mm)
 D = 6" (152.4 mm)
 E = Ceiling Cutout Min: 4" for ceiling thickness ≤ 10mm;
 4.2" for ceiling thickness > 10mm

6-inch:

A = 7.75" (196.8mm)
 B = 4.5" (114.2mm)
 C = 24" (609.6mm)
 D = 6" (152.4mm)
 E = Ceiling Cutout Min: 5.6"

8-inch:

A = 9.75" (247.6mm)
 B = 5.1" (129.4mm)
 C = 24" (609.6mm)
 D = 6" (152.4mm)
 E = Ceiling Cutout Min: 7.6"

Round Shape

4-inch:

A = 5.6" (142.3 mm)
 B = 3.74" (95 mm)
 C = 24" (609.6 mm)
 D = 6" (152.4 mm)
 E = Ceiling Cutout Min: 4.4"

6-inch:

A = 7.75" (196.8 mm)
 B = 4.5" (114.2 mm)
 C = 24.0" (609.6 mm)
 D = 6" (152.4 mm)
 E = Ceiling Cutout Min: 5.7"

8-inch:

A = 9.75" (247.6 mm)
 B = 5.1" (129.4 mm)
 C = 24.0" (609.6 mm)
 D = 6" (152.4 mm)
 E = Ceiling Cutout Min: 7.7"

10-inch:

A = 12" (305 mm)
 B = 5.8" (148.2 mm)
 C = 24.0" (609.6 mm)
 D = 6" (152.4 mm)
 E = Ceiling Cutout Min: 9.7"

12-inch:

A = 14" (355 mm)
 B = 6.23" (158.2 mm)
 C = 24.0" (609.6 mm)
 D = 6" (152.4 mm)
 E = Ceiling Cutout Min: 11.7"

Accessories: Lumination® LRX Series - Remodel (Goof) Rings

The essential accessory for any project, the goof ring helps to cover openings in the ceiling with a trim that blends with the existing LRX trim. Goof rings are available in white only. Verify the existing opening and LRX fixture to order the correct goof ring, details shown in the table below. Always verify proper installation per the Installation Guide.

Installation Position

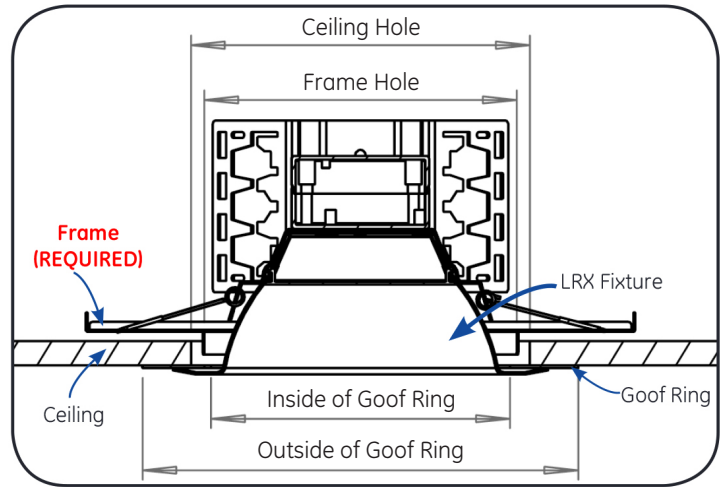
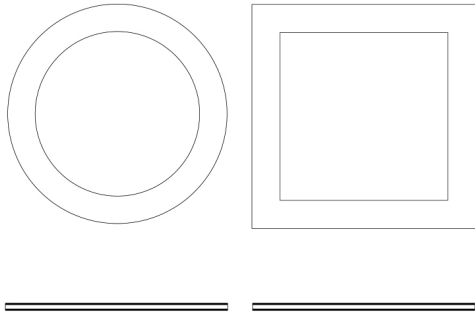

Note: Please check the compatibility of the goof ring and the fixture by referring to the table below.

A. For Retrofit

GOOF RING SKU	GOOF RING DESCRIPTION	GOOF RING SHAPE	SUITABLE FIXTURE	SUITABLE FRAME	FRAME HOLE	INSIDE OF GOOF RING	OUTSIDE OF GOOF RING	CEILING HOLE (MIN.)	CEILING HOLE (MAX.)
				DIMENSIONS (IN.)	SIZE (IN.)	SIZE (IN.)	SIZE (IN.)	SIZE (IN.)	SIZE (IN.)
93114516	GRRX4R6PTWT	ROUND	LRXR4XXXXXXXX	12.60 X 7.64 X 3.54	4.20-4.70	4.48	7.09	5.20	6.69
93114517	GRRX4S6PTWT	SQUARE	LRXS4XXXXXXXX	12.60 X 7.64 X 3.54	4.20-4.90	4.48	7.09	5.20	6.19
93114518	GRRX6R8PTWT	ROUND	LRXR6XXXXXXXX	12.60 X 7.64 X 3.54	5.91-6.50	6.18	9.00	6.50	8.60
93114519	GRRX6S8PTWT	SQUARE	LRXS6XXXXXXXX	13.35 X 11.34 X 3.54	5.95-7.50	6.22	8.98	7.50	8.08
93114520	GRRX8R10PTWT	ROUND	LRXR8XXXXXXXX	15.55 X 11.34 X 3.54	7.68-8.27	7.87	10.50	8.27	10.10
93114521	GRRX8S10PTWT	SQUARE	LRXS8XXXXXXXX	13.35 X 11.34 X 3.54	7.95-9.50	8.23	10.98	9.50	10.08
93114522	GRRX8R12PTWT	ROUND	LRXR8XXXXXXXX	15.55 X 11.34 X 3.54	7.68-8.27	7.87	12.99	10.10	12.59
93114523	GRRX8S12PTWT	SQUARE	LRXS8XXXXXXXX	13.35 X 11.34 X 3.54	7.95-9.50	8.23	12.99	10.58	12.09





B. For New Construction

GOOF RING SKU	GOOF RING DESCRIPTION	GOOF RING SHAPE	SUITABLE FIXTURE	SUITABLE FRAME	INSIDE OF GOOF RING	OUTSIDE OF GOOF RING	CEILING HOLE (MIN.)	CEILING HOLE (MAX.)
					SIZE (IN.)	SIZE (IN.)	SIZE (IN.)	SIZE (IN.)
93114516	GRRX4R6PTWT	ROUND	LRXR4XXXXXXXX	FRAME4RXXXX	4.48	7.09	5.20	6.69
93114517	GRRX4S6PTWT	SQUARE	LRXS4XXXXXXXX	FRAME4SXXXX	4.48	7.09	5.20	6.19
93114518	GRRX6R8PTWT	ROUND	LRXR6XXXXXXXX	FRAME6RXXXX	6.18	9.00	6.50	8.60
93114519	GRRX6S8PTWT	SQUARE	LRXS6XXXXXXXX	FRAME6SXXXX	6.22	8.98	7.50	8.08
93114520	GRRX8R10PTWT	ROUND	LRXR8XXXXXXXX	FRAME8RXXXX	7.87	10.50	8.27	10.10
93114521	GRRX8S10PTWT	SQUARE	LRXS8XXXXXXXX	FRAME8SXXXX	8.23	10.98	9.50	10.08
93114522	GRRX8R12PTWT	ROUND	LRXR8XXXXXXXX	FRAME8RXXXX	7.87	12.99	10.10	12.59
93114523	GRRX8S12PTWT	SQUARE	LRXS8XXXXXXXX	FRAME8SXXXX	8.23	12.99	10.58	12.09

Accessories: Lumination® LRX Series

PRODUCT DESCRIPTION	MATERIAL DESCRIPTION	MATERIAL	NOTES
EMERGENCY BATTERY BACKUP KIT (7W)	LRXEMBBKIT07	93043031	7 WATT EMBB QUICK CONNECT KIT (MUST HAVE FIXTURE WITH "EL" OPTION)
EMERGENCY BATTERY BACKUP KIT (10W)	LRXEMBBKIT10	93043540	10 WATT EMBB QUICK CONNECT KIT (MUST HAVE FIXTURE WITH "EL" OPTION)
4" NEW CONSTRUCTION ROUND FRAME KIT	FRAME4R	93090208	RECOMMENDED FOR NEW CONSTRUCTION APPLICATIONS
6" NEW CONSTRUCTION ROUND FRAME KIT	FRAME6R	93025091	RECOMMENDED FOR NEW CONSTRUCTION APPLICATIONS
8" NEW CONSTRUCTION ROUND FRAME KIT	FRAME8R	93025092	RECOMMENDED FOR NEW CONSTRUCTION APPLICATIONS
10" NEW CONSTRUCTION ROUND FRAME KIT	FRAME10R	93124880	RECOMMENDED FOR NEW CONSTRUCTION APPLICATIONS
12" NEW CONSTRUCTION ROUND FRAME KIT	FRAME12R	93124881	RECOMMENDED FOR NEW CONSTRUCTION APPLICATIONS
4" NEW CONSTRUCTION SQUARE FRAME KIT	FRAME4S	93090209	RECOMMENDED FOR NEW CONSTRUCTION APPLICATIONS
6" NEW CONSTRUCTION SQUARE FRAME KIT	FRAME6S	93045426	RECOMMENDED FOR NEW CONSTRUCTION APPLICATIONS
8" NEW CONSTRUCTION SQUARE FRAME KIT	FRAME8S	93045427	RECOMMENDED FOR NEW CONSTRUCTION APPLICATIONS
347V KIT	LRX347V277	93036250	347V TRANSFORMER QUICK CONNECT KIT
DAINTREE CONTROLS ACCESSORY KIT	LCACBAVTQUNGALV	93057194	SEE LCA KIT LITERATURE & INSTALL GUIDE, DOES NOT INCLUDE SENSOR
SENSOR ACCESSORY KIT - DAINTREE ENTERPRISE	LSAATZFM6	93098473	SEE LSA KITS LITERATURE & INSTALL GUIDE
SENSOR ACCESSORY KIT - DAINTREE ONE & EZ CONNECT	LSAATT/T1FM6	93098472	SEE LSA KITS LITERATURE & INSTALL GUIDE
HANGER BAR, C-CHANNEL, 25-1/4" (Boxed Pair)	BH3	93110306	RECOMMENDED FOR NEW CONSTRUCTION APPLICATIONS
UL DIRECT MOUNT KIT	LRX-EXTD-KIT-01	93120622	RECOMMENDED FOR CEILING APPLICATIONS WITHOUT EXISTING FRAME KIT (4 IN. & 6 IN. ONLY)

Accessories: Lumination® LRX Series Colored Round Trim Options:

	PRODUCT DESCRIPTION	MATERIAL DESCRIPTION	MATERIAL	LUMEN OUTPUT
	LRXR6 ROUND 6" TRIM INSERT, BLACK	LRXR6TRIMBL	93059501	70%
	LRXR6 ROUND 6" TRIM INSERT, SILVER	LRXR6TRIMSV	93059502	90%
	LRXR8 ROUND 8" TRIM INSERT, BLACK (NOT AVAILABLE IN 3000LM)	LRXR8TRIMBL	93059503	70%
	LRXR8 ROUND 8" TRIM INSERT, SILVER (NOT AVAILABLE IN 3000LM)	LRXR8TRIMSV	93059504	85%

Photometric Data: Lumination® LRX Series Downlights

Performance Summary:

0-10V Dimming

NOMINAL LUMENS	650	1000	1800	3000	4000	5000	6000
Delivered Lumens-LRX*4	700	1020	N/A	N/A	N/A	N/A	N/A
Delivered Lumens-LRX*6	700	1050	1900	N/A	N/A	N/A	N/A
Delivered Lumens-LRX*8	750	1200	2000	3300	N/A	N/A	N/A
Delivered Lumens-LRXR10	N/A	N/A	N/A	3180	4600	5400	6200
Delivered Lumens-LRXR12	N/A	N/A	N/A	N/A	4650	5450	6250
System Input Power (W)	8.5	13	22	35	41	49	59.5
System Efficacy (LPW)	88	92	91	94	112	110	104

Forward Phase Dimming

NOMINAL LUMENS	650	1000	1800	3000	4000
Delivered Lumens-LRXR4	620	990	N/A	N/A	N/A
Delivered Lumens-LRXR6	660	1060	1820	N/A	N/A
Delivered Lumens-LRXR8	710	1140	1960	3180	4080
System Input Power (W)	7	11	19	29	41
System Efficacy (LPW)	101	103	103	109	99

* LPW based off of LRXR8 delivered lumens

Delivered Lumen Multipliers

CCT	MULTIPLIERS
4000K	1
3500K	0.98
3000K	0.94

4" Round LRX (EX: LRXR410830MD)

LUMINANCE DATA (CD/SQ.M)

Angle	0°	45°	90°
45°	44163	43507	44576
55°	31383	30998	31794
65°	19283	19142	19599
75°	12977	12649	12986
85°	6327	6456	8002

ZONAL LUMEN SUMMARY

Zone	Lumens
0-10	50.98
10-20	143.53
20-30	208.85
30-40	226.68
40-50	194.68
50-60	131.45
60-70	66.78
70-80	29.04
80-90	6.9
90-100	0.04
100-110	0.04
110-120	0.03
120-130	0.02
130-140	0.02
140-150	0.02
150-160	0.02
160-170	0.01
170-180	0.00

RC	COEFFICIENTS OF UTILIZATION																				
	80%						70%				50%				30%			10%			0%
	RW	70%	50%	30%	10%	70%	50%	30%	10%	50%	30%	10%	50%	30%	10%	50%	30%	10%	0%		
0	119	119	119	119	116	116	116	116	111	111	111	106	106	106	102	102	102	100			
1	111	107	103	100	108	105	102	99	101	98	96	97	95	93	93	92	90	88			
2	103	96	90	85	100	94	89	84	90	86	82	87	84	80	84	81	79	77			
3	95	86	79	73	92	84	78	73	81	76	71	79	74	70	76	72	69	67			
4	88	77	70	64	86	76	69	63	74	67	63	71	66	62	69	65	61	59			
5	81	70	62	56	79	69	62	56	67	60	55	65	59	55	63	58	54	52			
6	76	64	56	50	74	63	55	50	61	54	49	60	54	49	58	53	49	47			
7	71	58	50	45	69	58	50	45	56	49	44	55	49	44	53	48	44	42			
8	66	54	46	41	65	53	46	40	52	45	40	51	44	40	49	44	40	38			
9	62	50	42	37	61	49	42	37	48	41	37	47	41	37	46	40	36	35			
10	58	46	39	34	57	46	38	34	45	38	34	44	38	33	43	37	33	32			

ZONAL LUMEN SUMMARY			
Zone	Lumens	% of Lamp	% of Fixture
0-20	194.51	N.A.	18.4
0-30	403.36	N.A.	38.1
0-40	630.04	N.A.	59.5
0-60	956.17	N.A.	90.3
0-80	1052	N.A.	99.3
0-90	1058.9	N.A.	100

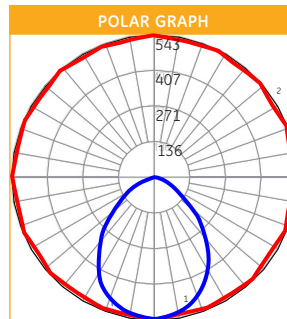

Photometric Data: Lumination® LRX Series Downlights

6" Round LRX (EX: LRXR610830MD)

ZONAL LUMEN SUMMARY	
Zone	Lumens
0-10°	48.26
10-20°	135.99
20-30°	199.14
30-40°	221.96
40-50°	188.12
50-60°	118.95
60-70°	54.04
70-80°	25.47
80-90°	7.78
90-100°	0.06
100-110°	0.02
110-120°	0.03
120-130°	0.03
130-140°	0.04
140-150°	0.05
150-160°	0.05
160-170°	0.03
170-180°	0.01

COEFFICIENTS OF UTILIZATION																			
RC	80%				70%				50%				30%				10%	0%	
RW	70%	50%	30%	10%	70%	50%	30%	10%	50%	30%	10%	50%	30%	10%	50%	30%	10%	0%	
0	119	119	119	119	116	116	116	116	111	111	111	111	106	106	106	102	102	102	100
1	111	107	104	100	108	105	102	99	101	98	96	97	95	93	93	92	90	88	
2	103	96	90	85	100	94	89	85	91	86	83	87	84	81	85	82	79	77	
3	95	86	79	74	93	85	78	73	82	76	72	79	75	71	77	73	69	68	
4	88	78	70	64	86	76	69	64	74	68	63	72	67	62	70	65	62	60	
5	82	70	63	57	80	69	62	57	67	61	56	66	60	55	64	59	55	53	
6	76	64	56	51	74	63	56	50	62	55	50	60	54	50	59	53	49	47	
7	71	59	51	45	69	58	51	45	57	50	45	55	49	45	54	48	44	43	
8	66	54	46	41	65	53	46	41	52	45	41	51	45	40	50	44	40	39	
9	62	50	42	37	61	49	42	37	48	42	37	47	41	37	46	41	37	35	
10	59	46	39	34	57	46	39	34	45	38	34	44	38	34	43	38	34	32	

NOTE: Floor Cavity Reflectance : 20%

ZONAL LUMEN SUMMARY		
Zone	Lumens	% of Fixture
0-20°	184.25	18.40
0-30°	383.39	38.30
0-40°	605.34	60.50
0-60°	912.41	91.20
0-80°	991.92	99.20
0-90°	999.70	100.00

LUMINANCE DATA (CANDELA/m²)			
Gamma	0°	45°	90°
45°	17519	17519	17519
55°	11682	11682	11682
65°	6286	6286	6286
75°	4723	4723	4723
85°	4000	4000	4000

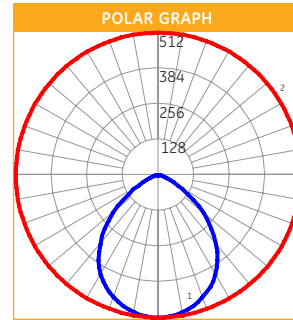

8" Round LRX (EX: LRXR818830MD)

ZONAL LUMEN SUMMARY	
Zone	Lumens
0-10°	87.00
10-20°	245.00
20-30°	357.94
30-40°	405.72
40-50°	355.72
50-60°	213.19
60-70°	84.35
70-80°	37.58
80-90°	10.61
90-100°	0.07
100-110°	0.14
110-120°	0.29
120-130°	0.44
130-140°	0.54
140-150°	0.55
150-160°	0.48
160-170°	0.31
170-180°	0.10

COEFFICIENTS OF UTILIZATION																			
RC	80%				70%				50%				30%				10%	0%	
RW	70%	50%	30%	10%	70%	50%	30%	10%	50%	30%	10%	50%	30%	10%	50%	30%	10%	0%	
0	119	119	119	119	116	116	116	116	111	111	111	111	106	106	106	102	102	102	100
1	111	107	104	101	108	105	102	99	101	98	96	97	95	93	94	92	90	88	
2	103	96	91	86	101	94	89	85	91	87	83	88	84	81	85	82	79	78	
3	95	87	80	74	93	85	79	74	82	77	72	80	75	71	77	73	70	68	
4	88	78	71	65	86	77	70	65	75	68	64	72	67	63	70	66	62	60	
5	82	71	63	57	80	70	63	57	68	61	56	66	60	56	64	59	55	53	
6	76	65	57	51	75	64	56	51	62	55	50	60	54	50	59	54	50	48	
7	71	59	51	46	70	58	51	46	57	50	45	56	50	45	54	49	45	43	
8	67	54	47	41	65	54	46	41	52	46	41	51	45	41	50	45	41	39	
9	62	50	43	38	61	50	42	38	49	42	37	47	41	37	47	41	37	35	
10	59	47	39	34	57	46	39	34	45	39	34	44	38	34	43	38	34	32	

NOTE: Floor Cavity Reflectance : 20%

ZONAL LUMEN SUMMARY		
Zone	Lumens	% of Fixture
0-20°	332.00	18.40
0-30°	689.94	38.30
0-40°	1095.66	60.90
0-60°	1664.57	92.50
0-80°	1786.51	99.20
0-90°	1797.12	99.80

LUMINANCE DATA (CANDELA/m²)			
Gamma	0°	45°	90°
45°	8251	8251	8251
55°	4433	4433	4433
65°	1645	1645	1645
75°	827	827	827
85°	263	263	263

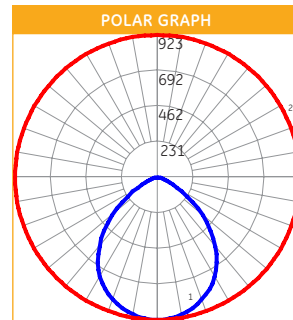

Photometric Data: Lumination® LRX Series Downlights

10" Round LRX (EX: LRXR1030830MD)

ZONAL LUMEN SUMMARY	
Zone	Lumens
0-10°	265.56
10-20°	751.07
20-30°	1109.15
30-40°	1284.03
40-50°	1192.46
50-60°	797.55
60-70°	323.82
70-80°	129.46
80-90°	39.60

COEFFICIENTS OF UTILIZATION																					
RC	80%				70%				50%				30%				10%				0%
	RW	70%	50%	30%	10%	70%	50%	30%	10%	50%	30%	10%	50%	30%	10%	50%	30%	10%	0%		
0	119	119	119	119	116	116	116	116	111	111	111	111	106	106	106	102	102	102	100		
1	111	107	103	100	108	105	102	99	101	98	96	97	95	93	93	92	90	88			
2	103	96	90	85	100	94	89	84	90	86	82	87	84	80	84	81	79	77			
3	95	86	79	73	92	84	78	72	81	76	71	79	74	70	76	72	69	67			
4	88	77	69	64	85	76	69	63	73	67	62	71	66	61	69	64	61	59			
5	81	70	62	56	79	69	61	55	67	60	55	65	59	54	63	58	54	52			
6	75	63	55	49	74	62	55	49	61	54	49	59	53	48	58	52	48	46			
7	70	58	50	44	69	57	49	44	56	49	44	54	48	43	53	47	43	41			
8	66	53	45	40	64	52	45	40	51	44	39	50	44	39	49	43	39	37			
9	61	49	41	36	60	48	41	36	47	41	36	46	40	36	45	40	35	34			
10	58	45	38	33	56	45	38	33	44	37	33	43	37	33	42	36	33	31			

NOTE: Floor Cavity Reflectance : 20%

ZONAL LUMEN SUMMARY			
Zone	Lumens	% of Lamp	% of Fixture
0-20°	538.49	N.A.	17.20
0-30°	2125.78	N.A.	36.00
0-40°	3409.81	N.A.	57.80
0-60°	5399.82	N.A.	91.50
0-80°	5853.11	N.A.	99.20
0-90°	5892.71	N.A.	99.90
10-90°	5627.15	N.A.	95.40
20-40°	2393.19	N.A.	40.60
20-50°	3585.65	N.A.	60.80
40-70°	2313.83	N.A.	39.20
60-80°	453.28	N.A.	7.70
70-80°	129.46	N.A.	2.20
80-90°	39.60	N.A.	0.70

LUMINANCE DATA (CANDELA/m²)			
Gamma	0°	45°	90°
45°	46649	45043	42706
55°	33288	31136	28351
65°	15584	13789	12024
75°	10055	9402	8587
85°	8788	7135	5268

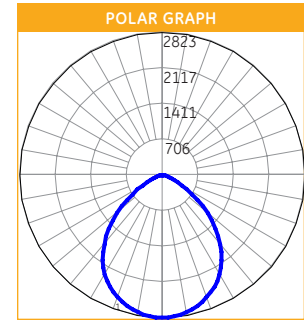

12" Round LRX (EX: LRXR1260830MD)

ZONAL LUMEN SUMMARY	
Zone	Lumens
0-10°	254.76
10-20°	726.52
20-30°	1087.3
30-40°	1279.7
40-50°	1270.85
50-60°	939.08
60-70°	372.27
70-80°	106.14
80-90°	33.16

COEFFICIENTS OF UTILIZATION																					
RC	80%				70%				50%				30%				10%				0%
	RW	70%	50%	30%	10%	70%	50%	30%	10%	50%	30%	10%	50%	30%	10%	50%	30%	10%	0%		
0	119	119	119	119	116	116	116	116	111	111	111	111	106	106	106	102	102	102	100		
1	111	107	103	100	108	105	102	99	100	98	96	97	95	93	93	91	90	88			
2	102	95	90	85	100	93	88	84	90	86	82	87	83	80	84	81	78	76			
3	94	85	78	72	92	84	77	72	81	75	70	78	73	69	76	72	68	66			
4	87	76	69	63	85	75	68	62	73	66	61	70	65	60	68	64	60	58			
5	80	69	61	55	78	68	60	54	66	59	54	64	58	53	62	57	53	51			
6	75	62	54	48	73	61	54	48	60	53	48	58	52	47	56	51	47	45			
7	69	57	49	43	68	56	48	43	54	48	42	53	47	42	52	46	42	40			
8	65	52	44	39	63	51	44	38	50	43	38	49	43	38	48	42	38	36			
9	60	48	40	35	59	47	40	35	46	39	35	45	39	34	44	38	34	32			
10	57	44	37	32	55	44	36	32	43	36	31	42	36	31	41	35	31	30			

NOTE: Floor Cavity Reflectance : 20%

ZONAL LUMEN SUMMARY			
Zone	Lumens	% of Lamp	% of Fixture
0-20°	981.28	N.A.	16.10
0-30°	2068.58	N.A.	34.00
0-40°	3348.28	N.A.	55.10
0-60°	5558.22	N.A.	91.50
0-80°	6036.63	N.A.	99.30
0-90°	6069.79	N.A.	99.90
10-90°	5815.03	N.A.	95.70
20-40°	2367.00	N.A.	39.00
20-50°	3637.86	N.A.	59.90
40-70°	2582.21	N.A.	42.50
60-80°	478.41	N.A.	7.90
70-80°	106.14	N.A.	1.70
80-90°	33.16	N.A.	0.50

LUMINANCE DATA (CANDELA/m²)			
Gamma	0°	45°	90°
45°	34433	33802	32705
55°	27077	26316	24737
65°	12345	11465	10159
75°	5579	5431	5147
85°	4929	4534	3874

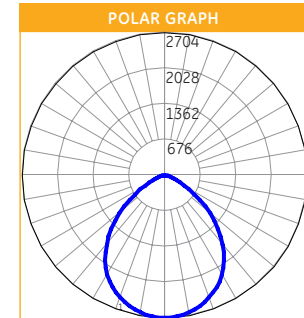

Photometric Data: Lumination® LRX Series Downlights

4" Square LRX (EX: LRXS410830MD)

ZONAL LUMEN SUMMARY	
Zone	Lumens
0-10°	48.79
10-20°	136.05
20-30°	195.03
30-40°	214.18
40-50°	192.29
50-60°	143.00
60-70°	81.10
70-80°	27.89
80-90°	6.20
90-100°	0.79
100-110°	0.65
110-120°	0.37
120-130°	0.23
130-140°	0.18
140-150°	0.13
150-160°	0.10
160-170°	0.06
170-180°	0.01

COEFFICIENTS OF UTILIZATION																			
RC	80%				70%				50%				30%				10%		0%
RW	70%	50%	30%	10%	70%	50%	30%	10%	50%	30%	10%	50%	30%	10%	50%	30%	10%	0%	
0	119	119	119	119	116	116	116	116	111	111	111	106	106	106	102	102	102	100	
1	111	107	103	100	108	104	101	98	100	98	95	96	94	92	93	91	89	87	
2	102	95	89	84	100	93	88	83	90	85	81	86	83	79	83	80	78	76	
3	94	85	78	72	92	83	77	71	80	75	70	78	73	69	75	71	68	66	
4	87	76	68	63	85	75	68	62	73	66	61	70	65	60	68	64	60	58	
5	81	69	61	55	79	68	60	55	66	59	54	64	58	53	62	57	53	51	
6	75	63	54	49	73	62	54	48	60	53	48	58	52	48	57	51	47	45	
7	70	57	49	44	68	56	49	43	55	48	43	54	47	43	52	47	42	41	
8	65	53	45	39	64	52	44	39	51	44	39	49	43	39	48	43	38	37	
9	61	49	41	36	60	48	41	36	47	40	35	46	40	35	45	39	35	33	
10	57	45	38	33	56	44	37	33	43	37	32	43	37	32	42	36	32	30	

NOTE: Floor Cavity Reflectance : 20%

ZONAL LUMEN SUMMARY			
Zone	Lumens	% of Lamp	% of Fixture
0-20°	184.85	N.A.	17.7
0-30°	379.88	N.A.	36.3
0-40°	594.06	N.A.	56.7
0-60°	929.35	N.A.	88.8
0-80°	1038.34	N.A.	99.2
0-90°	1044.54	N.A.	99.8

LUMINANCE DATA (CANDELA/m²)			
Gamma	0°	45°	90°
45°	35273	36299	35256
55°	27588	27635	27301
65°	18968	18839	18210
75°	8602	9764	7882
85°	6858	7083	5183

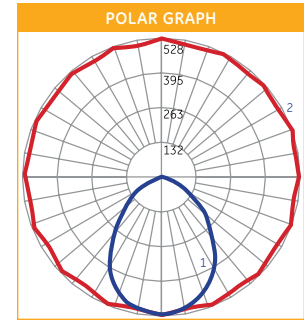

6" Square LRX (EX: LRXS610830MD)

ZONAL LUMEN SUMMARY	
Zone	Lumens
0-10°	48.40
10-20°	137.38
20-30°	203.26
30-40°	229.80
40-50°	202.64
50-60°	136.51
60-70°	63.03
70-80°	22.61
80-90°	6.12
90-100°	0.03
100-110°	0.00
110-120°	0.00
120-130°	0.00
130-140°	0.02
140-150°	0.06
150-160°	0.05
160-170°	0.03
170-180°	0.01

COEFFICIENTS OF UTILIZATION																			
RC	80%				70%				50%				30%				10%		0%
RW	70%	50%	30%	10%	70%	50%	30%	10%	50%	30%	10%	50%	30%	10%	50%	30%	10%	0%	
0	119	119	119	119	116	116	116	116	111	111	111	106	106	106	102	102	102	100	
1	111	107	104	101	108	105	102	99	101	98	96	97	95	93	93	92	90	88	
2	103	96	90	85	100	94	89	84	91	86	82	87	84	81	84	81	79	77	
3	95	86	79	73	93	84	78	73	81	76	71	79	74	70	76	72	69	67	
4	88	77	70	64	86	76	69	63	74	67	63	71	66	62	69	65	61	59	
5	81	70	62	56	79	69	61	56	67	60	55	65	59	55	63	58	54	52	
6	76	64	56	50	74	63	55	50	61	54	49	59	53	49	58	53	48	47	
7	70	58	50	45	69	57	50	44	56	49	44	55	48	44	53	48	44	42	
8	66	53	46	40	64	53	45	40	51	45	40	50	44	40	49	44	39	38	
9	62	49	42	37	60	49	41	36	48	41	36	47	40	36	46	40	36	34	
10	58	46	38	33	57	45	38	33	44	38	33	43	37	33	42	37	33	31	

NOTE: Floor Cavity Reflectance : 20%

ZONAL LUMEN SUMMARY			
Zone	Lumens	% of Lamp	% of Fixture
0-20°	185.78	N.A.	17.70
0-30°	389.04	N.A.	37.10
0-40°	618.84	N.A.	58.90
0-60°	957.99	N.A.	91.20
0-80°	1043.63	N.A.	99.40
0-90°	1049.74	N.A.	100.00

LUMINANCE DATA (CANDELA/m²)			
Gamma	0°	45°	90°
45°	17826	19831	17826
55°	12430	14165	12430
65°	6627	8018	6627
75°	3963	4079	3963
85°	3057	3057	3057

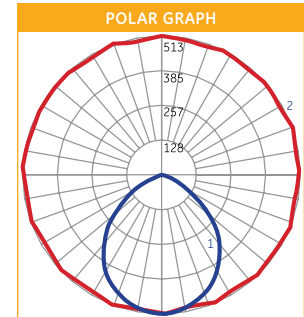

Photometric Data: Lumination® LRX Series Downlights

8" Square LRX (EX: LRXS810830MD)

ZONAL LUMEN SUMMARY	
Zone	Lumens
0-10°	51.81
10-20°	147.65
20-30°	220.84
30-40°	258.58
40-50°	243.12
50-60°	169.22
60-70°	75.23
70-80°	25.23
80-90°	7.77
90-100°	0.37
100-110°	0.00
110-120°	0.00
120-130°	0.00
130-140°	0.00
140-150°	0.05
150-160°	0.05
160-170°	0.03
170-180°	0.01

COEFFICIENTS OF UTILIZATION																					
RC	80%				70%				50%				30%				10%				0%
	RW	70%	50%	30%	10%	70%	50%	30%	10%	50%	30%	10%	50%	30%	10%	50%	30%	10%	0%		
0	119	119	119	119	116	116	116	116	111	111	111	106	106	106	102	102	102	100	100		
1	111	107	103	100	108	105	101	99	100	98	95	97	95	93	93	91	90	88	88		
2	102	95	90	85	100	94	88	84	90	86	82	87	83	80	84	81	78	76	76		
3	94	85	78	73	92	84	77	72	81	75	71	78	73	69	76	72	68	66	66		
4	87	77	69	63	85	75	68	62	73	67	62	71	65	61	69	64	60	58	58		
5	81	69	61	55	79	68	60	55	66	59	54	64	58	54	62	57	53	51	51		
6	75	63	55	49	73	62	54	49	60	53	48	58	52	48	57	52	47	45	45		
7	70	57	49	43	68	56	49	43	55	48	43	54	47	43	52	47	42	41	41		
8	65	52	45	39	64	52	44	39	50	44	39	49	43	39	48	43	38	37	37		
9	61	48	41	35	59	48	40	35	47	40	35	46	39	35	45	39	35	33	33		
10	57	45	37	32	56	44	37	32	43	37	32	42	36	32	41	36	32	30	30		

NOTE: Floor Cavity Reflectance : 20%

ZONAL LUMEN SUMMARY			
Zone	Lumens	% of Lamp	% of Fixture
0-20°	199.46	N.A.	16.6
0-30°	420.3	N.A.	35
0-40°	678.88	N.A.	56.6
0-60°	1091.22	N.A.	90.9
0-80°	1191.68	N.A.	99.3
0-90°	1199.45	N.A.	100

LUMINANCE DATA (CANDELA/m²)			
Gamma	0°	45°	90°
45°	11581	12804	11581
55°	7966	10235	7966
65°	3805	5993	3805
75°	2116	3248	2116
85°	1680	3547	1680

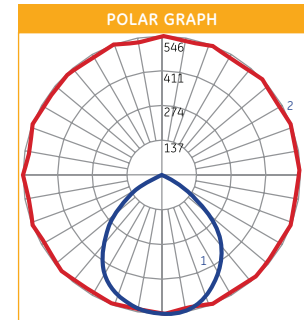

Selectable Driver Package:

The Lumination® LRX Series comes with a Selectable Driver Package which allows customers to manually switch from full power to lower power with just the switch of a button. This affords flexibility to stock fewer SKUs. Reduces install risk by effectively having multiple lumen levels in one simple package. The 4, 6 and 8-inch downlights are available with 650/1000lm switchable levels, and the 10 and 12-inch downlights are available with 4000/5000/6000lm switchable levels.



*Photo depicts the 1000/650lm package.

Product Specifications:

Construction:

- 16 gauge Aluminum spinning reflector housing, powder coating
- Custom engineered heat sink flange for passive cooling on all lumen options

Installation:

- Fixture mounting to an existing metal frame, or install with new frame kit (ordered separately), interior ceiling applications only.
- Conduit connect to quick-disconnect for easy installation
- Optional black or silver trims available (ordered separately)

Optical System:

- Custom engineered reflectors for wide distributions.
- Semi-diffuse diffuser for ideal combination of optical efficiency and uniformity

Electrical System:

- High Efficiency, integrated driver with 0-10V dimming or Forward Phase Dimming
- Selectable Lumen Driver available in the 1000/650lm and 4000/5000/6000lm packages (see ordering notes).

For more information and access to all of our resources, including our design tool visit: www.gecurrent.com



© 2021 Current Lighting Solutions, LLC. All rights reserved. GE and the GE monogram are trademarks of the General Electric Company and are used under license. Information provided is subject to change without notice. All values are design or typical values when measured under laboratory conditions.