

## Multi-Channel Nonmetallic Raceway System

### Available Factory Prewired.

5500 Series Raceway from provides wire and cable management for data, voice, A/V, and power applications. It is ideal for large cable and wire requirements in schools, office buildings, and other institutions.

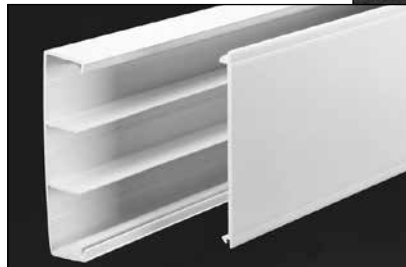

Triple Channel Configuration of 5500 Series Raceway Base.

5500 Series Raceway installation.



### FEATURES & BENEFITS

- **2" (51mm) bend radius compliant fittings.** These fittings snap onto overlap raceway base and cover for an aesthetic installation. Fittings are cULus verified for a 2" (51mm) bend radius and exceed the recommendations of TIA/EIA-569. They provide cable protection in lay-in and pull-through cable installations.
- **Three channel raceway with breakaway dividers.** Low-voltage and power wiring can be run in the same raceway. Flexible for future moves and changes.
- **Large cable capacity in a low profile design.** Accommodates needs now and in the future.
- **Devices can be mounted in-line, offset or combined.** No need to remove dividers or install boxes to mount devices, eliminates unnecessary labor. Up to four separate services can be installed in the same location.
- **Full series of face plates are available for power, data, voice, and video applications.** Industry standard devices and face plates can also be mounted.
- **Made of rugged durable PVC material.** Lightweight and easy to cut. Paintable using latex paint. Easy to clean.
- **Compatible with A/V devices by using 5507 Series Faceplates.**
- **Supplied in standard 8-foot (2.44m) lengths.** Installs quicker. Fewer joints to cover. Consult factory for custom colors and lengths.
- **Offered in ivory and white finishes.** Blends with any decor.
- **Available prewired.** Manufactured to specific job site lengths, raceway comes completely prewired, ready to install. Jobs can be packaged by room, floor, or building and shipped per job site requirements.
- **Communication connectivity options.** Accepts industry standard and proprietary devices from a wide range of manufacturers to provide a seamless and aesthetically pleasing interface for voice, data, audio, and video applications at the point of use.
- **UL and cUL Listed component raceways.** File E90378 Guide RJTX, Fittings: File E90377 Guide RJYT. Meets Article 388 of NEC and meets Section 12-600 of CEC.



Prewired 5500 Series Raceway reduces installation time.

## 5500 Series Raceway System Layout

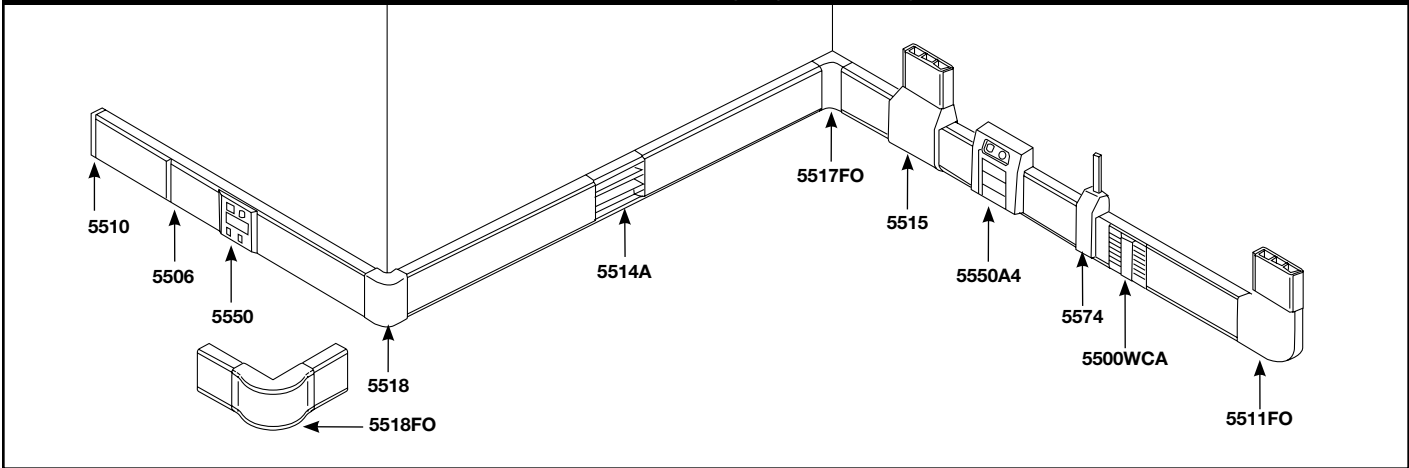

**NOTE:** Illustration is for showing product applications only.

## 5500 Series Raceway Wire Fill Capacities

### 5500 Series Raceway Wire Fill Capacities for Communications

CABLE TYPE	CABLE/WIRE SIZE	O.D. (Approx. Dia.) Inches      (mm)		20% FILL			40% FILL		
				C	A	B	C	A	B
Unshielded Twisted Pair	4-pair, 24 AWG Cat. 3	0.190	(4.8)	57	18	35	114	37	71
	4-pair, 24 AWG Cat. 5e	0.220	(5.6)	47	15	29	94	30	58
	4-pair, 24 AWG Cat. 6	0.250	(6.3)	33	10	20	66	21	41
	4-pair, 24 AWG Cat. 6a	0.354	(8.9)	16	5	10	33	10	20
Telephone	2-pair, 24 AWG	0.140	(3.6)	105	34	65	211	68	131
	3-pair, 24 AWG	0.150	(3.8)	92	29	57	184	59	114
	4-pair, 24 AWG	0.190	(4.8)	57	18	35	114	37	71
	25-pair, 24 AWG	0.410	(10.4)	12	4	7	24	8	15
Coaxial	RG58/U	0.195	(5.0)	54	17	33	109	35	67
	RG59/U	0.242	(6.1)	35	11	22	70	22	44
	RG62/U	0.242	(6.1)	35	11	22	70	22	44
	RG6/U	0.270	(6.9)	28	9	17	56	18	35
Twinaxial	100 ohm	0.330	(8.4)	19	6	11	38	12	23
Shielded Twisted Pair	TYPE 1	0.390	(9.9)	13	4	8	27	8	16
	TYPE 2	0.465	(11.8)	9	3	5	19	6	11
	TYPE 3	0.245	(6.2)	34	11	21	69	22	42
Fiber	Mini ZipCord	0.079 x 0.157(2 x 4)		131	42	81	262	85	163
	ZipCord	0.118 x 0.236(3 x 6)		58	18	36	117	37	72
	Round 4 Strand Fiber	0.187	(4.8)	59	19	36	118	38	73
	Round 6 Strand Fiber	0.256	(6.5)	31	30	19	63	20	39

**NOTE:** Wire capacity is reduced to allow for proper conductor bend radius and maximum permissible heat rise.  
 Category 6 augmented (6a) cable for 10 gigabit ethernet – max allowed cable diameter per addenda No. 11 ANSI TIA/EIA 568-B.2.

Download this product's PEP ecopassport® environmental product declaration at [www.legrand.us/resources-and-downloads](http://www.legrand.us/resources-and-downloads). This declaration conforms with ISO 14025 and 14040 and is in alignment with EN 15804.

## 5500 Series Raceway Wire Fill Capacities (continued)

### 5500 Series Raceway Wire Fill Capacities for Power

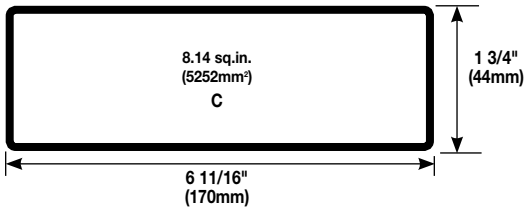
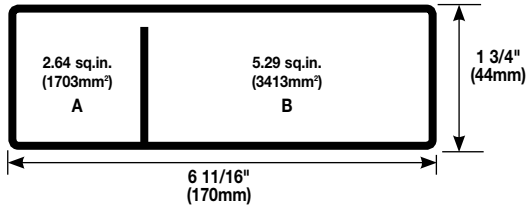
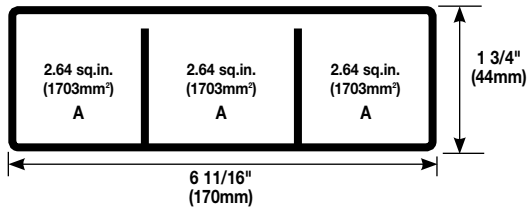

	WIRE SIZE THHN/THWN	O.D. (Approx. Dia.)		NUMBER OF CONDUCTORS PER COMPARTMENT		
		Inches	(mm)	C	A	B
<b>POWER WIRING WITHOUT DEVICES</b>	14 AWG	0.111	(2.8)	64	41	50
	12 AWG	0.130	(3.3)	60	25	44
	10 AWG	0.164	(4.2)	90	46	70
	8 AWG	0.216	(5.5)	65	18	40
	6 AWG	0.254	(6.5)	45	15	34
<b>POWER WIRING WITH DEVICES</b>	14 AWG	0.111	(2.8)	64	35	50
	12 AWG	0.130	(3.3)	60	25	44
	10 AWG	0.164	(4.2)	90	16	70
	8 AWG	0.216	(5.5)	65	8	36
	6 AWG	0.254	(6.5)	45	5	25

**NOTE:** Total raceway wire capacity, in any configuration, can not exceed capacity specified in C. Two A compartments can not exceed the capacity specified for compartment B.

20% cable fill is calculated to approximate reduction in cable capacity due to connectors mounted within raceway and fittings that may restrict cross sectional area.

40% cable fill is the maximum designed cable fill based on a proposed revision to TIA/EIA 569-A.

### 5500 Series Raceway Fittings Ordering Information

Catalog No./Item	Description/Specifications
5500BD3*	<b>Divided Base</b> – Three equal compartments – use for separate services in one raceway. Breakaway dividers enable multiple compartment configurations.
5500C*	<b>Cover</b> – Use with 5500BD3.
5500WC	<b>Wire Clip</b> – Holds wires in raceway.

Catalog No./Item	Description/Specifications
5506*	<b>Cover Clip</b> – Covers seam between sections of 5500C Cover come together.
5506B*	<b>Base Seam Clip</b> – Covers seam where two sections of 5500BD3 Base come together.

\*Available in Ivory finish or add "-WH" suffix for White finish.

## 5500 Series Raceway Fittings Ordering Information (continued)

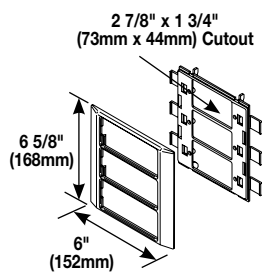
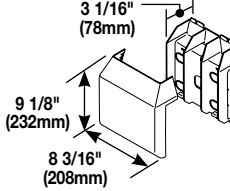
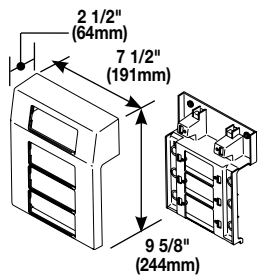
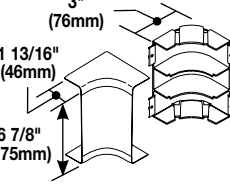
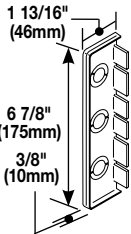
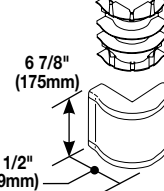
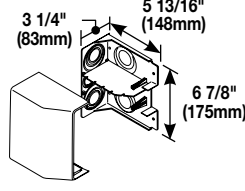
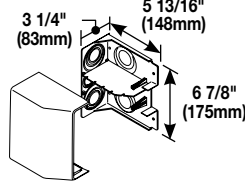
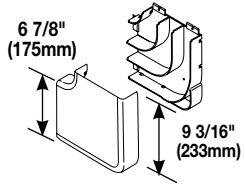
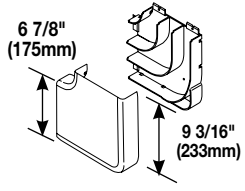
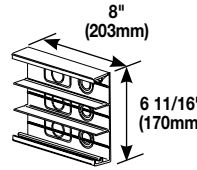
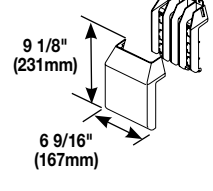
Catalog No./Item	Description/Specifications	Catalog No./Item	Description/Specifications
<b>5550*</b> 	<b>Device Bracket</b> – Mounts power and communication devices in-line with the raceway. For use with: 5507 Series Faceplates, Ortronics® TracJack & Series II Modules, Pass & Seymour® Activate Series Inserts, and Wiremold CM2 Open System Communication Modules.	<b>5515*</b> 	<b>Tee/Take-Off Connector</b> – For branching raceway at right angles.
<b>5550A4*</b> 	<b>Device Bracket</b> – Mounts power and communication devices in-line and offset with the raceway. For use with: 5507 Series Faceplates, Ortronics® TracJack & Series II Modules, Pass & Seymour® Activate Series Inserts, and Wiremold CM2 Open System Communication Modules.	<b>5517FO*</b> 	<b>Bend Radius Control Full Capacity Internal Elbow</b> – 90° internal corner with integral dividers that provides a 2" (51mm) cable bend radius for <b>UTP and Fiber Optic installations</b> . Ideal for lay-in or pull-through installations.
<b>5510*</b> 	<b>End Cap</b> – Closes off end of 5500 Series Raceway and has three 1/2" trade size KO's for end feed.	<b>5518FO*</b> 	<b>Bend Radius Control Full Capacity External Elbow</b> – 90° external corner with integral dividers that provides a 2" (51mm) cable bend radius for <b>UTP and Fiber Optic installations</b> . Use the 5518FO for a radius alternative to the 5518.
<b>5510D*</b> 	<b>Entrance End Fitting</b> – Feeds raceway from larger conduits. Has concentric 3/4", 1", 1 1/2", and 2" trade size KO's on end and back. Two removable dividers are included.	<b>5518*</b> 	<b>External Elbow</b> – Joins lengths of raceway around external corners.
<b>5511FO*</b> 	<b>Bend Radius Control Full Capacity Flat Elbow</b> – 90° flat corner with integral dividers that provides a 2" (51mm) cable bend radius for <b>UTP and Fiber optic installations</b> . Ideal for lay-in or pull-through installations.	<b>5514*</b> 	<b>Transition Fitting</b> – 90° transition from 5500 Series Raceway to 400, 800, 2300, PN03, PN05, and PN10 Series Raceways.
<b>5514A*</b> 	<b>Backfeed Connector</b> – Use when a backfeed is needed. Has three rectangular KO's for use with existing wall box and three 1/2", 3/4", and 1" trade size KO's.	<b>5514A*</b> 	<b>Transition Fitting</b> – Makes a 90° transition from 5500 Series Raceway to 5400 Series Raceway.

\*Available in Ivory finish or add "-WH" suffix for White finish.

## 5507 Series Faceplates Ordering Information

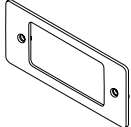
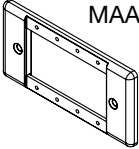
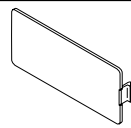
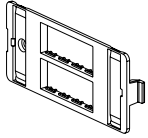
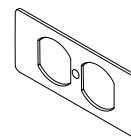
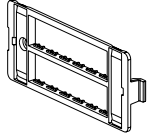
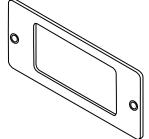
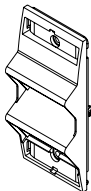
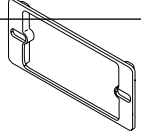
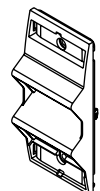
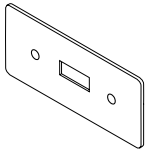
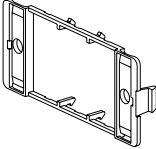
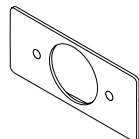
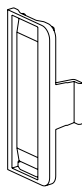
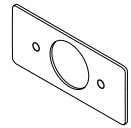
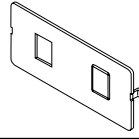
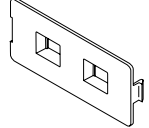
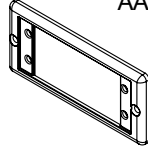
Catalog No./Item	Description/Specifications	Catalog No./Item	Description/Specifications
5507AD* 	<b>Modular Furniture Adapter</b> – Mounts modular furniture adapters.	5507MAAP 5507MAAP-WH 5507MAAP-G 5507MAAP-FW 	<b>Extron® MAAP Faceplate</b> – Accepts four Extron® Electronics MAAP single space modules.
5507B* 	<b>Blank Faceplate</b> – Covers unused compartments in the device bracket.	5507-4TJ* 	<b>Ortronics® Faceplate</b> – Mounts Ortronics® communication inserts. Accepts four TracJack Devices.
5507D* 	<b>Duplex Faceplate</b> – Covers duplex style devices. Accepts 106 Frame.	5507-6TJ* 	<b>Ortronics® Faceplate</b> – Mounts Ortronics® communication inserts. Accepts six TracJack Devices.
5507R* 	<b>Rectangular Faceplate</b> – Covers rectangular style devices.	ARA-S2 	<b>Angled Raceway Adapter</b> – For use with multi-channel raceway device brackets and WallSource device mounting brackets. Angled exit provides additional mounting depth required for A/V connections as well as ensuring the required bend radius for UTP and fiber optic cabling. Holds two Ortronics® Series II modules. Fits 5507 Series Faceplate opening.
5507S* 	<b>Rectangular Spacer</b> – For mounting commercial device plates. Installs between the device bracket and a device.	CM-ARA 	<b>Angled Raceway Adapter</b> – For use with multi-channel raceway device brackets and WallSource device mounting brackets. Angled exit provides additional mounting depth required for A/V connections as well as ensuring the required bend radius for UTP and fiber optic cabling. Holds two CM2 Series modules or two Pass & Seymour® 2A inserts. Fits 5507 Series Faceplate opening.
5507SW* 	<b>Switch Faceplate</b> – Covers standard toggle switches.	CM-EPLA* 	<b>End Plates</b> – Includes two outlet identification labels with clear covers and two matching screw covers. Required for mounting Pass & Seymour Activate and Wiremold CM2 Open System communication modules into 5550 Series device brackets.
5507T1* 	<b>Single Receptacle Faceplate</b> – Covers single receptacles – 1.59" (40mm) diameter.	S2-EPL 	<b>End Plates</b> – Includes two outlet identification labels with clear covers and two matching screw covers. Required for mounting Ortronics Series II modules into 5550 Series device brackets.
5507T2* 	<b>Single Receptacle Faceplate</b> – Covers single receptacles – 1.41" (36mm) diameter.		
5507RJ* 	<b>Dual RJ11/RJ45 Connector Faceplate</b> – Mounts one or two RJ keystone type connectors – has one opening and a KO for the other.		
5507FRJ* 	<b>Flush Dual RJ11/RJ45 Connector Faceplate</b> – Same as 5507RJ except the connectors are recessed to provide a flush installation.		
5507AAP 5507AAP-WH 5507AAP-G 5507AAP-FW 	<b>Extron® AAP Faceplate</b> – Accepts two Extron® Electronics AAP single space modules.		

NOTE: All faceplates are 4 1/4" long x 1 11/16" wide (108mm x 43mm).  
\* Available in Ivory finish or add "-WH" suffix for White finish.

## 5500 Series Raceway Prewired Features

Features	Standard	Options
<b>Communication Devices</b>	Ortronics or Pass & Seymour Activate™ Connectivity System Devices	Other manufacturers
<b>Electrical Devices</b>	Pass & Seymour	Other manufacturers and some International devices
<b>Base Length</b>	Longest = 8' (2.4m), shortest = 1' (305mm)	–
<b>Finish</b>	PVC – White or Ivory	Custom colors
<b>Wire Type</b>	THHN Stranded	Options per specification
<b>Wiring Splices</b>	Insulation displacement connectors	Continuous wiring or twist-on wire connector
<b>Grounding Conductors</b>	Wire gauge per National Electrical Code (NEC) and shared grounding wires	Oversized and/or separate grounding wires
<b>Device Identification</b>	Gray self-adhesive polyester label with black letters	Self-adhesive engraved nameplate
<b>Neutrals</b>	Shared neutral	Oversized and/or separate neutral wires
<b>Pigtails</b>	1' (305mm) feeds and receptacle leads	Per specification
<b>Conduit Feeds</b>	Raceway drilled at job site	Entrance end cap
<b>Record Drawings</b>	3 sets and 2 copies of marked-up blueprints	Per job requirements
<b>Submittal Services</b>	Detailed Submittal	Submittal Free

## Device and Raceway Labeling Detail for Prewired Applications

- Device labeling is available in the following materials:
  - Gray self-adhesive polyester label with black lettering (standard).
  - Other color self-adhesive polyester labels.
  - Engraving of covers with black lettering.
  - Engraved phenolic nameplates with adhesive backing.
- The back of the raceway is labeled with the raceway number and the room or area number(s).
- Data and power requirements can be switched with data on top and power on bottom.

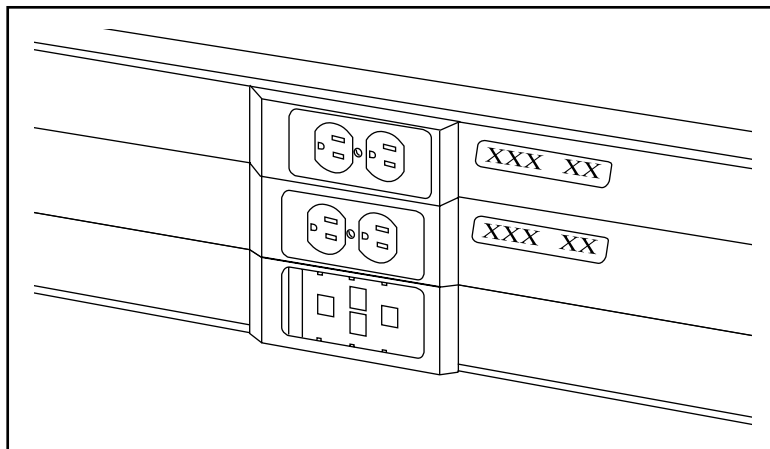

## 5500 Series Raceway Ordering Specifications for Prewired Applications

**Two options available when ordering a prewired job:**

- 1. Detailed Submittal** The detailed submittal will show exactly how each raceway run will be built including lengths, number and type of receptacles, wiring schematics, circuiting information, etc. The contractor and/or distributor must review, clarify any information not clearly indicated on the drawings or specs, approve, and return to the factory before production can begin.
- 2. Submittal Free** The Wiremold Prewired Express™ Building Plan Checklist is filled out by the contractor or distributor and sent along with plans, casework, and specs to the factory. No submittal is required and the project is scheduled for production upon receipt of all necessary information.

## NOTES

# NOTES



**Electrical Wiring Systems**

60 Woodlawn Street  
West Hartford, CT 06110  
Phone: 1.877.BY.LEGRAND (295-3472)  
[www.legrand.us](http://www.legrand.us)

570 Applewood Crescent  
Vaughan, Ontario L4K 4B4  
Phone: 905.738.9195  
[www.legrand.ca](http://www.legrand.ca)

