

RH Series Compact Power Relays

SPDT through 4PDT, 10A contacts
Compact power type relays

The RH series are miniature power relays with a large capacity. The RH relays feature 10A contact capacity as large as the RR series but in a miniature package. The compact size saves space.

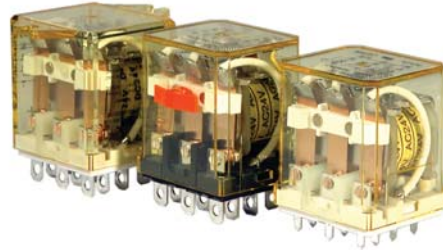

Part Number Selection

Contact	Model	Part Number		Coil Voltage Code (Standard Stock in bold)
		Blade Terminal	PCB Terminal	
 SPDT	Basic	RH1B-U	RH1V2-U	
	With Indicator	RH1B-UL	—	
	With Check Button	RH1B-UC	—	AC6V, AC12V, AC24V , AC110V, AC120V , AC220V, AC240V DC6V, DC12V , DC24V , DC48V, DC110V
	With Indicator and Check Button	RH1B-ULC	—	
	Top Bracket Mounting	RH1B-UT	—	
	With Diode (DC coil only)	RH1B-UD	RH1V2-UD	DC6V, DC12V , DC24V , DC48V, DC110V
	With Indicator and Diode (DC coil only)	RH1B-ULD	—	DC12V , DC24V , DC48V, DC110V
 DPDT	Basic	RH2B-U	RH2V2-U	
	With Indicator	RH2B-UL	RH2V2-UL	AC6V, AC12V, AC24V , AC110-120V , AC220-240V
	With Check Button	RH2B-UC	—	DC6V, DC12V , DC24V , DC48V, DC100-110V
	With Indicator and Check Button	RH2B-ULC	—	
	Top Bracket Mounting	RH2B-UT	—	
	With Diode (DC coil only)	RH2B-UD	RH2V2-UD	DC6V, DC12V , DC24V , DC48V, DC100-110V
	With Indicator and Diode (DC coil only)	RH2B-ULD	—	
 3PDT	Basic	RH3B-U	RH3V2-U	
	With Indicator	RH3B-UL	RH3V2-UL	AC6V, AC12V, AC24V , AC110V, AC120V , AC220V, AC240V DC6V, DC12V , DC24V , DC48V, DC110V
	With Check Button	RH3B-UC	—	
	With Indicator and Check Button	RH3B-ULC	—	
	Top Bracket Mounting	RH3B-UT	—	
	With Diode (DC coil only)	RH3B-D*	RH3V2-D*	DC6V, DC12V, DC24V, DC48V, DC110V
	With Indicator and Diode (DC coil only)	RH3B-LD*	—	
 4PDT	Basic	RH4B-U	RH4V2-U	
	With Indicator	RH4B-UL	RH4V2-UL	AC6V, AC12V, AC24V , AC110V, AC120V , AC220V, AC240V DC6V, DC12V , DC24V , DC48V, DC110V
	With Check Button	RH4B-UC	—	
	With Indicator and Check Button	RH4B-ULC	—	
	Top Bracket Mounting	RH4B-UT	—	
	With Diode (DC coil only)	RH4B-UD	RH4V2-UD	DC6V, DC12V, DC24V, DC48V, DC110V
	With Indicator and Diode (DC coil only)	RH4B-LD*	—	

- *Carries no UL recognition mark.
- PCB terminal relays are designed to mount directly to a circuit board without any socket.

Ordering Information

When ordering, specify the Part No. and coil voltage code:

(example) **RH3B-U** **AC120V**
Part No. Coil Voltage Code

Switches & Pilot Lights

Display Lights

Relays & Sockets





Timers

Terminal Blocks

Circuit Breakers

Sockets (for Blade Terminal Models)

Relays	Standard DIN Rail Mount ¹	Finger-safe DIN Rail Mount ¹	Through Panel Mount	PCB Mount
RH1B	SH1B-05	SH1B-05C	SH1B-51	SH1B-62
RH2B	SH2B-05	SH2B-05C	SH2B-51	SH2B-62
RH3B	SH3B-05	SH3B-05C	SH3B-51	SH3B-62
RH4B	SH4B-05	SH4B-05C	SH4B-51	SH4B-62

-  1. DIN Rail mount socket comes with two horseshoe clips. Do not use unless you plan to insert pullover wire spring. Replacement horseshoe clip part number is Y778-011.

Hold Down Springs & Clips

Appearance	Description	Relay	For DIN Mount Socket	For Through Panel & PCB Mount Socket	Min Order Qty
	Pullover Wire Spring	RH1B	SY2S-02F1 ²	SY4S-51F1	10
		RH2B	SY4S-02F1 ²		
		RH3B	SH3B-05F1 ²		
		RH4B	SH4B-02F1 ²		
	Leaf Spring (side latch)	RH1B, RH2B, RH3B, RH4B	SFA-202 ³	SFA-302 ³	20
		RH1B, RH2B, RH3B, RH4B	SFA-101 ³	SFA-301 ³	

-  2. Must use horseshoe clip when mounting in DIN mount socket. Replacement horseshoe clip part number is Y778-011.
3. Two required per relay.

AC Coil Ratings

Voltage (V)	Rated Current (mA) ±15% at 20°C								Coil Resistance (Ω) ±10% at 20°C				Operation Characteristics (against rated values at 20°C)		
	AC 50Hz				AC 60Hz				SPDT	DPDT	3PDT	4PDT	Max. Continuous Applied Voltage	Pickup Voltage	Dropout Voltage
	SPDT	DPDT	3PDT	4PDT	SPDT	DPDT	3PDT	4PDT							
6	170	240	330	387	150	200	280	330	330	9.4	6.4	5.4			
12	86	121	165	196	75	100	140	165	165	39.3	25.3	21.2			
24	42	60.5	81	98	37	50	70	83	83	153	103	84.5			
110	9.6	—	18.1	21.6	8.4	—	15.5	18.2	18.2	—	2,200	1,800			
110-120	—	9.4-10.8	—	—	—	8.0-9.2	—	—	—	—	—	—			
120	8.6	—	16.4	19.5	7.5	—	14.2	16.5	16.5	—	10,800	7,360			
220	4.7	—	8.8	10.7	4.1	—	7.7	9.1	9.1	—	10,800	7,360			
220-240	—	4.7-5.4	—	—	—	4.0-4.6	—	—	—	18,820	—	—			
240	4.9	—	8.2	9.8	4.3	—	7.1	8.3	8.3	—	12,100	9,120			

DC Coil Ratings

Voltage (V)	Rated Current (mA) ±15% at 20°C				Coil Resistance (Ω) ±10% at 20°C				Operation Characteristics (against rated values at 20°C)		
	SPDT	DPDT	3PDT	4PDT	SPDT	DPDT	3PDT	4PDT	Max. Continuous Applied Voltage	Pickup Voltage	Dropout Voltage
6	128	150	240	250	47	40	25	24	110%	80% maximum	10% minimum
12	64	75	120	125	188	160	100	96			
24	32	36.9	60	62	750	650	400	388			
48	18	18.5	30	31	2,660	2,600	1,600	1,550			
100-110	—	8.2-9.0	—	—	—	12,250	—	—			
110	8	—	12.8	15	13,800	—	8,600	7,340			

-  Standard coil voltages are in **BOLD**.

Contact Ratings

Maximum Contact Capacity						
Model	Continuous Current	Allowable Contact Power		Rated Load		
		Resistive Load	Inductive Load	Voltage (V)	Res. Load	Ind. Load
SPDT	10A	1540VA 300W	990VA 210W	110 AC	10A	7A
				220 AC	7A	4.5A
				30 DC	10A	7A
DPDT 3PDT 4PDT	10A	1650VA 300W	1100VA 225W	110 AC	10A	7.5A
				220 AC	7.5A	5A
				30 DC	10A	7.5A

Note: Inductive load for the rated load — $\cos \phi = 0.3$, L/R = 7 ms



TÜV Ratings

Voltage	RH1	RH2	RH3	RH4
240V AC	10A	10A	7.5A	7.5A
30V DC	10A	10A	10A	10A

AC: $\cos \phi = 1.0$, DC: L/R = 0 ms



Socket Specifications

	Sockets	Terminal	Electrical Rating	Wire Size	Torque
DIN Rail Mount Sockets	SH1B-05	(Coil) M3 screws (contact) M3.5 screws with captive wire clamp	250V, 10A	Maximum up to 2-#12AWG	5.5 - 9 in•lbs 9 - 11.5 in•lbs
	SH2B-05 SH3B-05 SH4B-05	M3.5 screws with captive wire clamp	300V, 10A	Maximum up to 2-#12AWG	9 - 11.5 in•lbs
	SH1B-05C	(coil) M3 screws (contact) M3.5 screws with captive wire clamp, fingersafe	250V, 10A	Maximum up to 2-#12AWG	5.5 - 9 in•lbs 9 - 11.5 in•lbs
	SH2B-05C SH3B-05C SH4B-05C	M3.5 screws with captive wire clamp, fingersafe	300V, 10A	Maximum up to 2-#12AWG	9 - 11.5 in•lbs
Through Panel Mount Socket	SH1B-51 SH2B-51 SH3B-51 SH4B-51	Solder	300V, 10A	—	—
PCB Mount Socket	SH1B-62	PCB mount	250V, 10A	—	—
	SH2B-62 SH3B-62 SH4B-62	PCB mount	300V, 10A	—	—

Accessories

Description	Appearance	Use with	Part No.	Remarks
Aluminum DIN Rail (1 meter length)		All DIN rail sockets	BNDN1000	IDEC offers a low-profile DIN rail (BNDN1000). The BNDN1000 is designed to accommodate DIN mount sockets. Made of durable extruded aluminum, the BNDN1000 measures 0.413 (10.5mm) in height and 1.37 (35mm) in width (DIN standard). Standard length is 39" (1,000mm).
DIN Rail End Stop		DIN rail	BNL5	9.1 mm wide.
Replacement Hold-Down Spring Anchor		DIN mount sockets and hold down springs.	Y778-011	For use on DIN rail mount socket when using pullover wire hold down spring. 2 pieces included with each socket.

UL Ratings

Voltage	Resistive			General Use			Horse Power Rating		
	RH1 RH2	RH3	RH4	RH1 RH2	RH3	RH4	RH1 RH2	RH3	RH4
240V AC	10A	7.5A	7.5A	7A	6.5A	5A	1/3 HP	1/3 HP	—
120V AC	—	10A	10A	—	7.5A	7.5A	1/6 HP	1/6 HP	—
30V DC	10A	10A	—	7A	—	—	—	—	—
28V DC	—	—	10A	—	—	—	—	—	—

CSA Ratings

Voltage	Resistive				General Use				Horse Power Rating
	RH1	RH2	RH3	RH4	RH1	RH2	RH3	RH4	RH1, 2, 3
240V AC	10A	10A	—	7.5A	7A	7A	7A	5A	1/3 HP
120V AC	10A	10A	10A	10A	7.5A	7.5A	—	7.5A	1/6 HP
30V DC	10A	10A	10A	10A	7A	7.5A	—	—	—

Switches & Pilot Lights

Display Lights

Relays & Sockets

Timers

Terminal Blocks

Circuit Breakers

Specifications

Contact Material		Silver cadmium oxide	
Contact Resistance ¹		50mΩ maximum	
Minimum Applicable Load		24V DC, 30 mA; 5V DC, 100 mA (reference value)	
Operate Time ²	SPDT DPDT	20ms maximum	
	3PDT 4PDT	25ms maximum	
Release Time ²	SPDT DPDT	20ms maximum	
	3PDT 4PDT	25ms maximum	
Power Consumption (approx.)	SPDT	AC: 1.1VA (50Hz), 1VA (60Hz)	DC: 0.8W
	DPDT	AC: 1.4VA (50Hz), 1.2VA (60Hz)	DC: 0.9W
	3PDT	AC: 2VA (50Hz), 1.7VA (60Hz)	DC: 1.5W
	4PDT	AC: 2.5VA (50Hz), 2VA (60Hz)	DC: 1.5W
Insulation Resistance		100MΩ minimum (500V DC megger)	
Dielectric Strength ³	SPDT	Between live and dead parts:	2,000V AC, 1 minute
		Between contact and coil:	2,000V AC, 1 minute
		Between contacts of the same pole:	1,000V AC, 1 minute
	DPDT 3PDT 4PDT	Between live and dead parts:	2,000V AC, 1 minute
	Between contact and coil:	2,000V AC, 1 minute	
	Between contacts of different poles:	2,000V AC, 1 minute	
	Between contacts of the same pole:	1,000V AC, 1 minute	
Operating Frequency		Electrical:	1,800 operations/hour maximum
		Mechanical:	18,000 operations/hour maximum
Vibration Resistance		Damage limits:	10 to 55Hz, amplitude 0.5 mm
		Operating extremes:	10 to 55Hz, amplitude 0.5 mm
Shock Resistance		Damage limits:	1,000m/s ² (100G)
		Operating extremes:	200m/s ² (20G - SPDT, DPDT) 100m/s ² (10G - 3PDT, 4PDT)
Mechanical Life		50,000,000 operations minimum	
Electrical Life	DPDT	500,000 operations minimum (120V AC, 10A)	
	SPDT		
	3PDT 4PDT	200,000 operations minimum (120V AC, 10A)	
Operating Temperature ⁴	SPDT	-25 to +50°C (no freezing)	
	DPDT		
	3PDT 4PDT	-25 to +40°C (no freezing)	
Operating Humidity		45 to 85% RH (no condensation)	
Weight (approx.)		SPDT: 24g, DPDT: 37g, 3PDT: 50g, 4PDT: 74g	



Note: Above values are initial values.

1. Measured using 5V DC, 1A voltage drop method
2. Measured at the rated voltage (at 20°C), excluding contact bouncing
Release time of relays with diode: 40 ms maximum
3. Relays with indicator or diode: 1000V AC, 1 minute
4. For use under different temperature conditions, refer to Continuous Load Current vs. Operating Temperature Curve. The operating temperature range of relays with indicator or diode is -25 to +40°C.

Characteristics (Reference Data)

Electrical Life Curves

AC Load

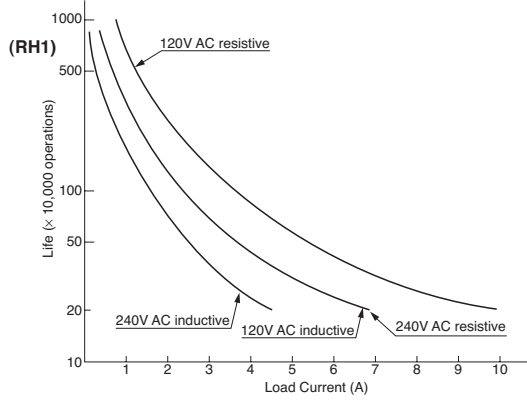

DC Load

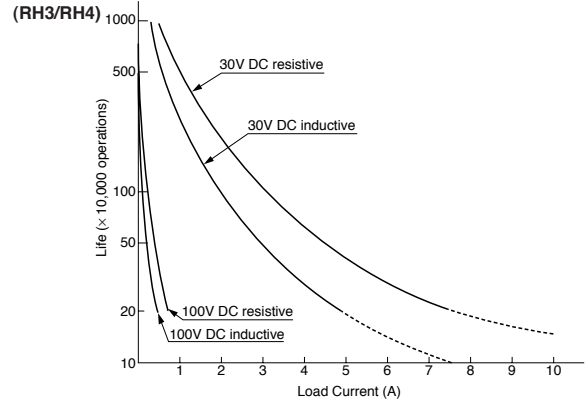
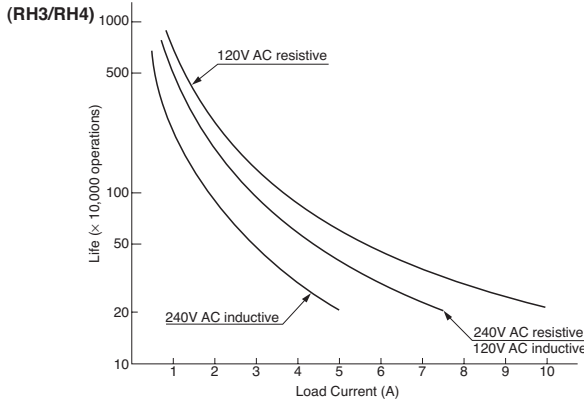
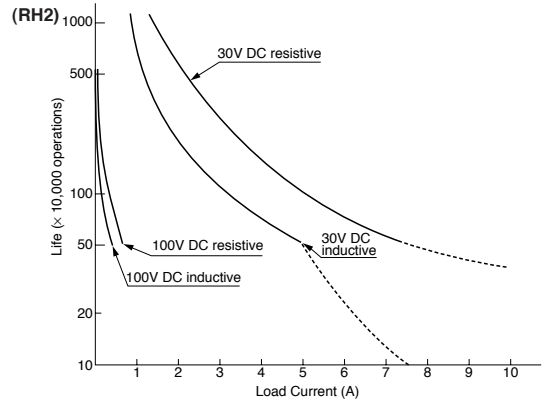
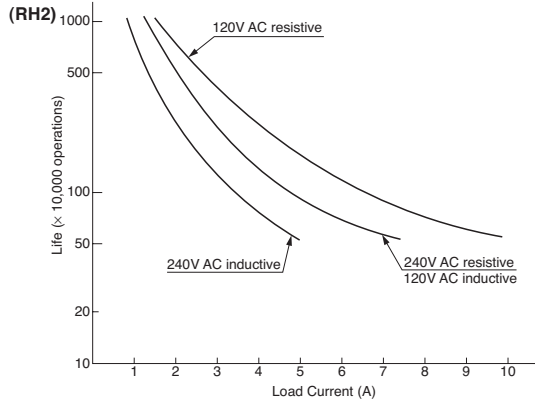
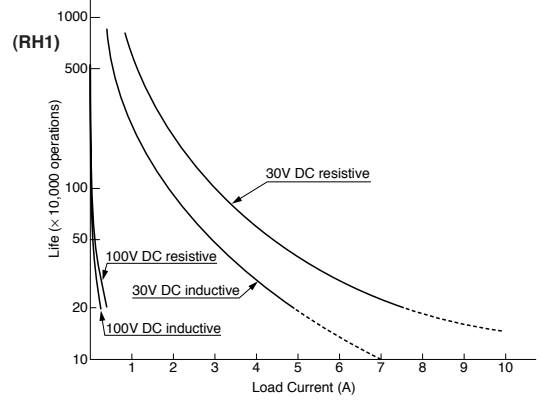

Maximum Switching Capacity

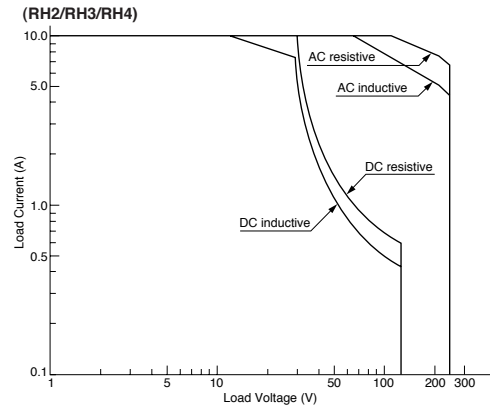
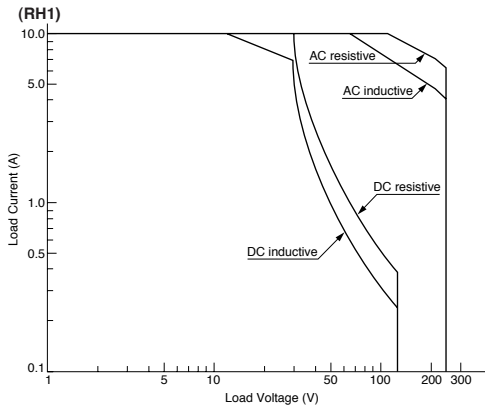

Switches & Pilot Lights

Display Lights

Relays & Sockets

Timers

Terminal Blocks

Circuit Breakers

Continuous Load Current vs. Operating Temperature Curve (Basic Type, With Check Button, and Top Bracket Mounting Type)

(RH1)

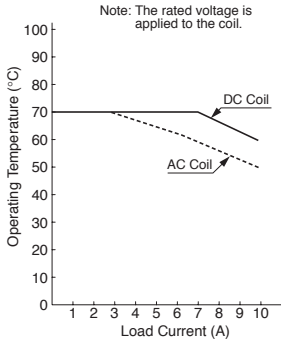

(RH2)

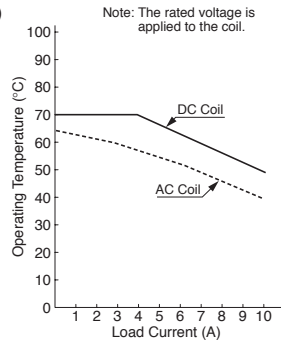

(RH3/RH4)

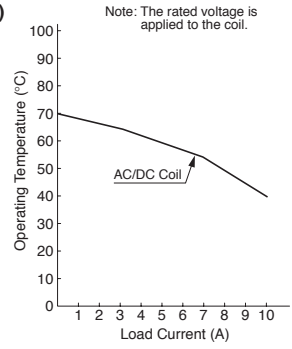

Internal Connection (View from Bottom)

Basic Type

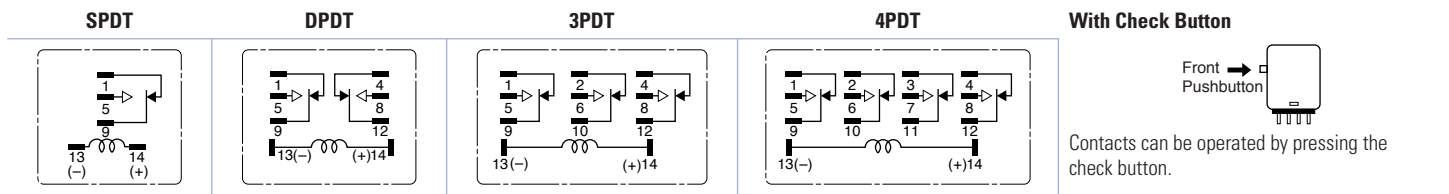

With Indicator (-L type)

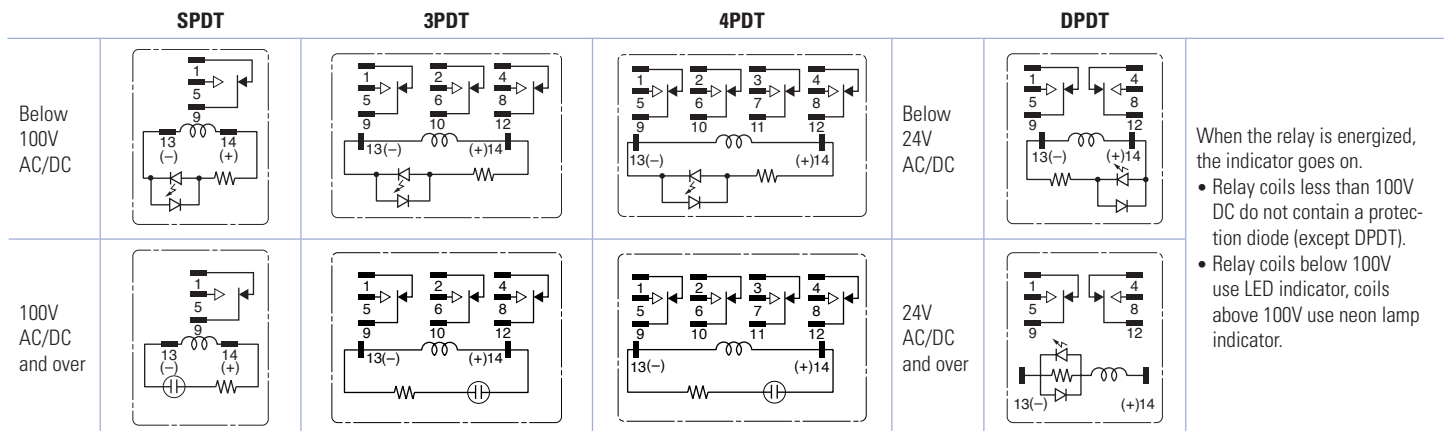

With Diode (-D type)

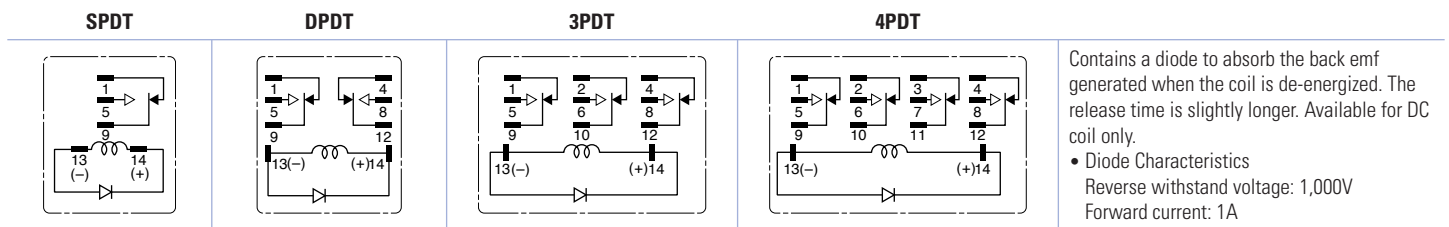

With Indicator LED & Diode (-LD type)

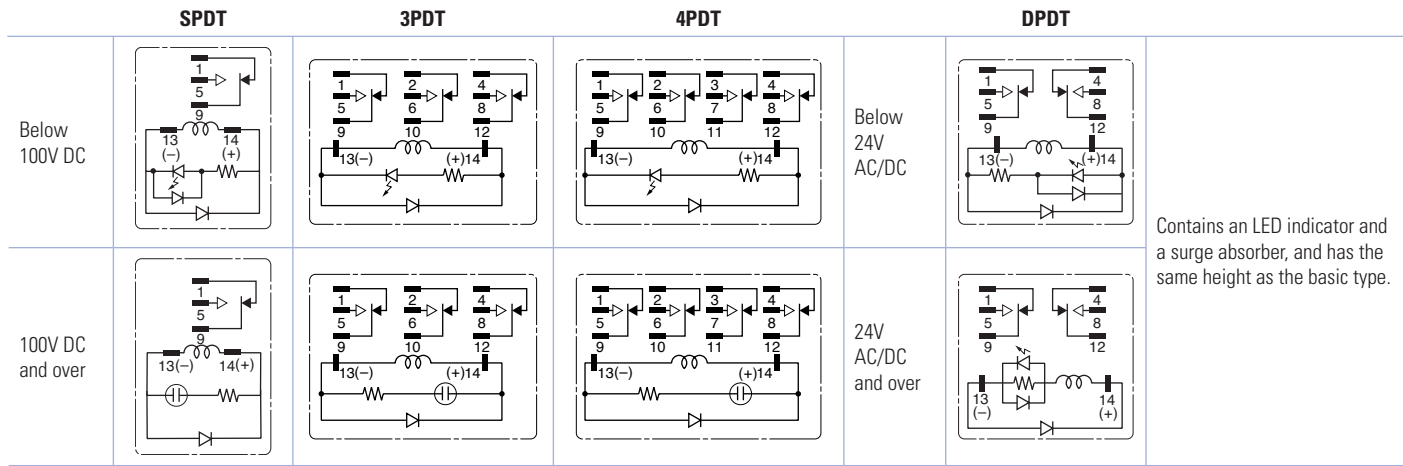

Contains an LED indicator and a surge absorber, and has the same height as the basic type.

Dimensions (mm)

RH1B-U/RH1B-UL/RH1B-UD/RH1B-ULD

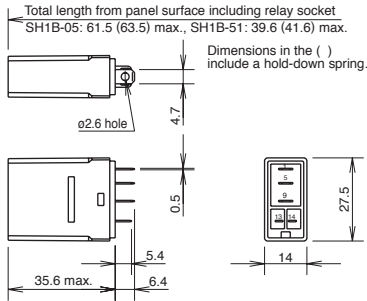

RH2B-U/RH2B-UL/RH2B-UD/RH2B-ULD

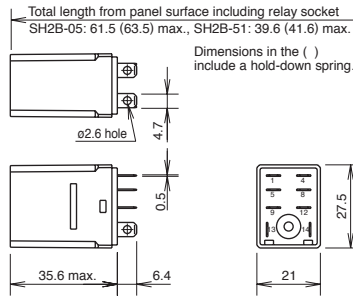

RH3B-U/RH3B-UL/RH3B-D/RH3B-LD

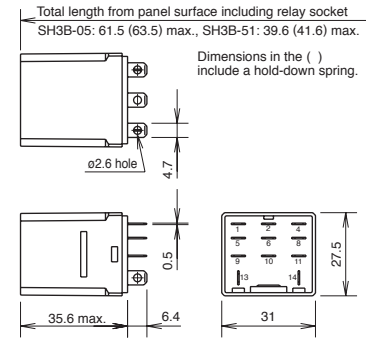

RH4B-U/RH4B-UL/RH4B-UD/RH4B-LD

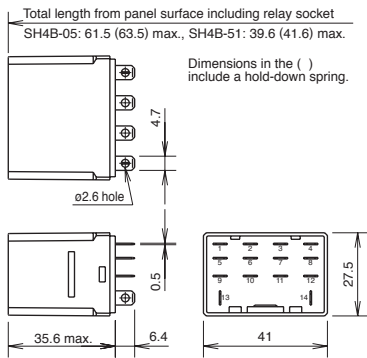

RH1B-UT

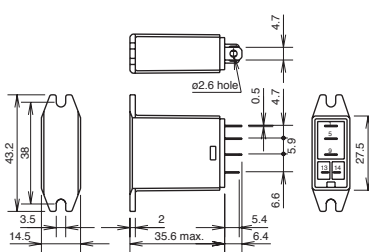

RH2B-UT

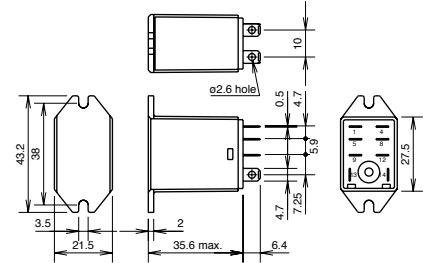

RH3B-UT

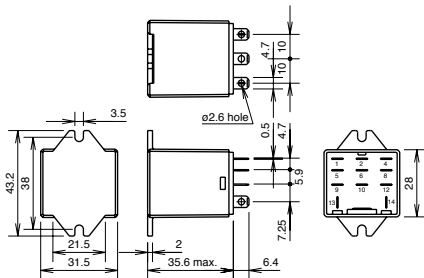

RH4B-UT

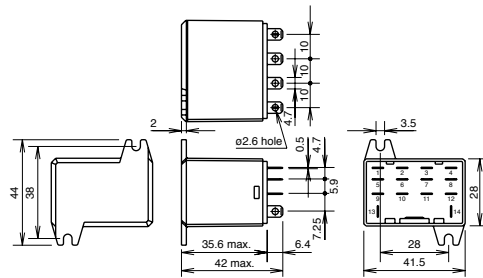

Dimensions con't (mm)

RH1V2-U/RH1V2-UD

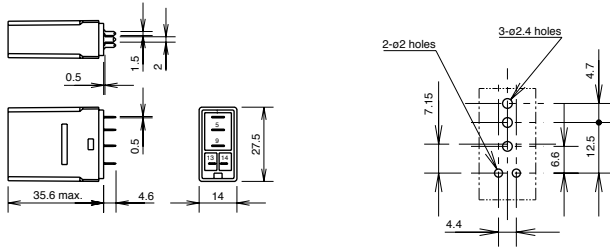

RH2V2-U/RH2V2-UL/RH2V2-UD

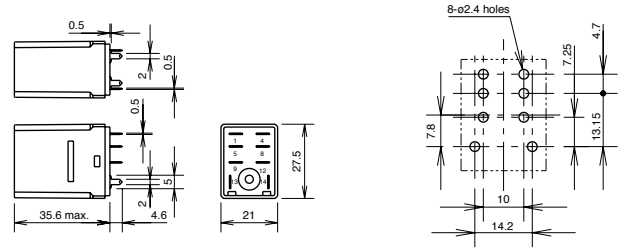

RH3V2-U/RH3V2-UL/RH3V2-D

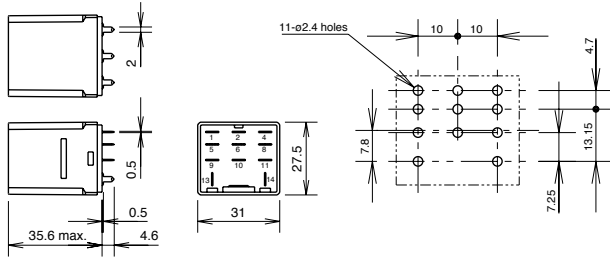

RH4V2-U/RH4V2-UL/RH4V2-UD

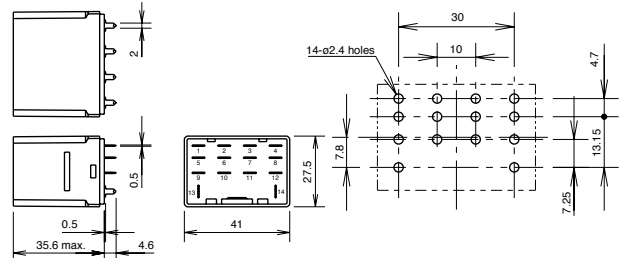

Standard DIN Rail Mount Sockets

SH1B-05

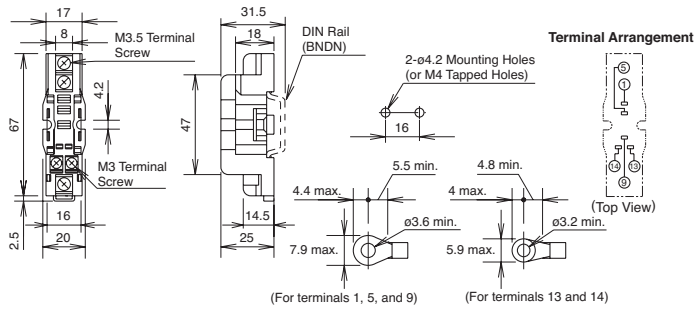

SH2B-05

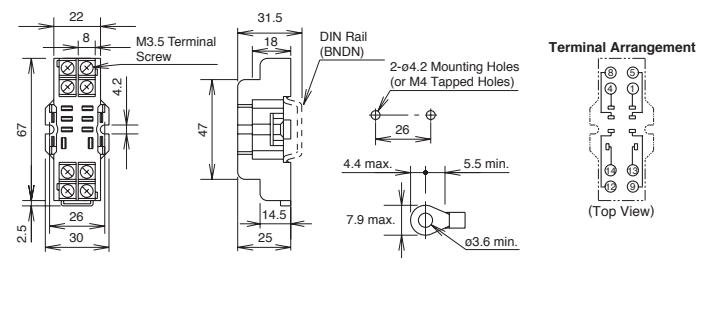

SH3B-05

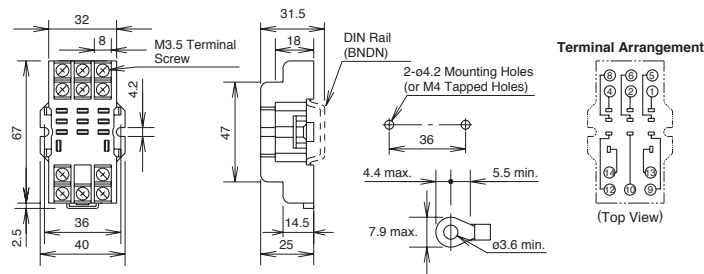

SH4B-05

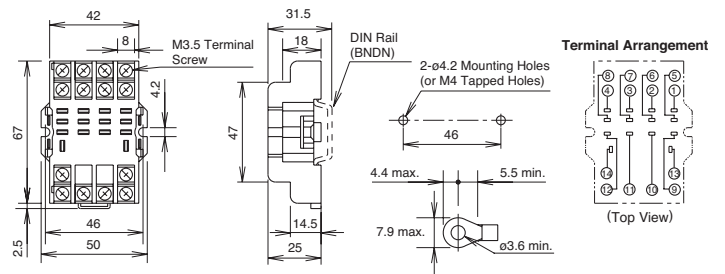

Dimensions con't (mm)

Finger-safe DIN Rail Mount Sockets

SH1B-05C

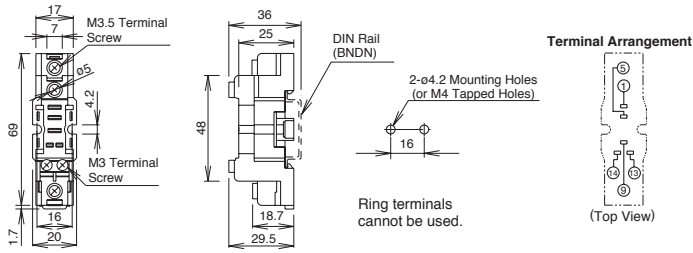

SH2B-05C

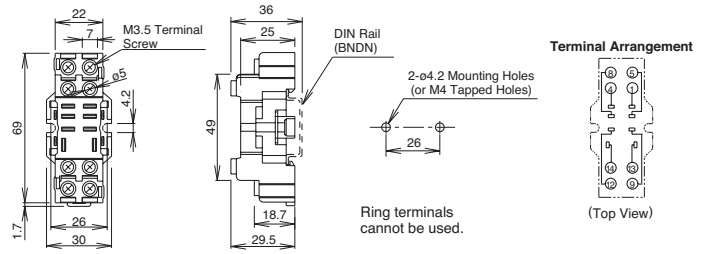

SH3B-05C

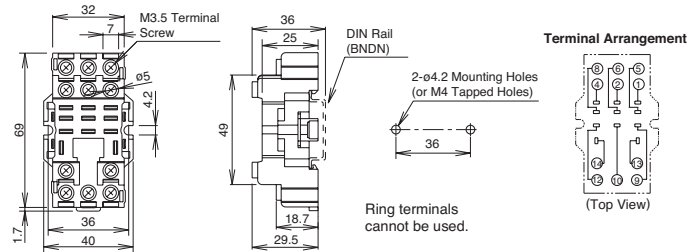

SH4B-05C

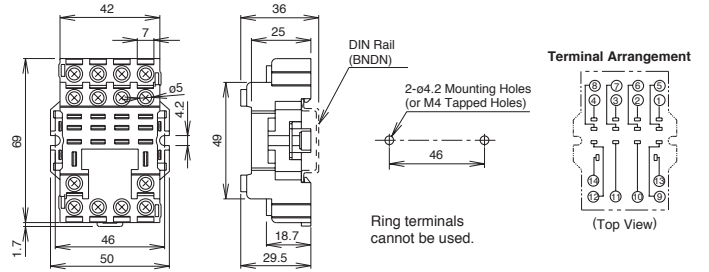

Through Panel Mount Socket

SH1B-51

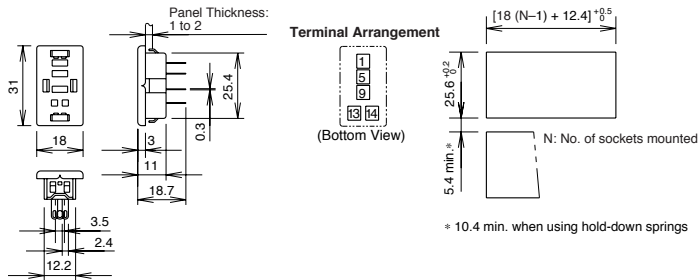

SH2B-51

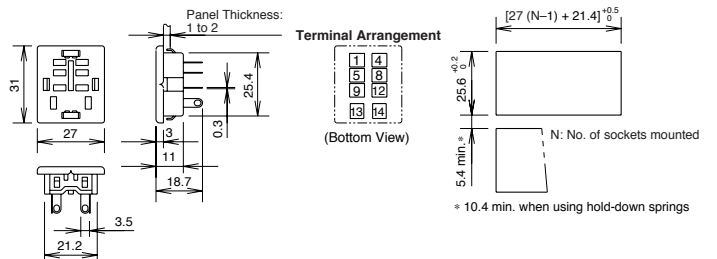

SH3B-51

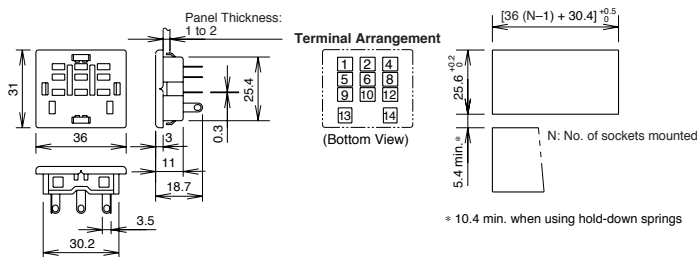

SH4B-51

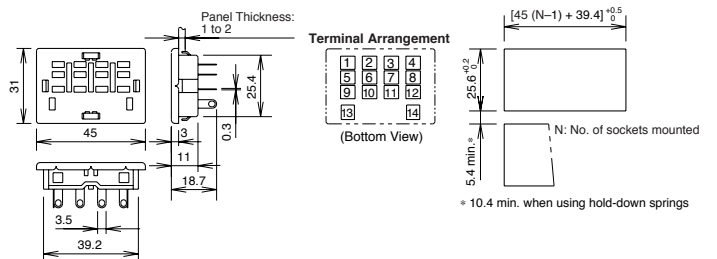

Switches & Pilot Lights

Display Lights

Relays & Sockets

Timers

Terminal Blocks

Circuit Breakers

Dimensions con't (mm)

PCB Mount Sockets

SH1B-62

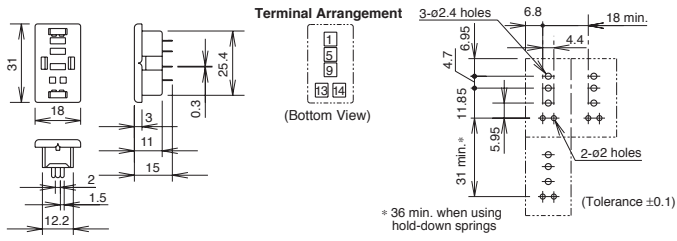

SH2B-62

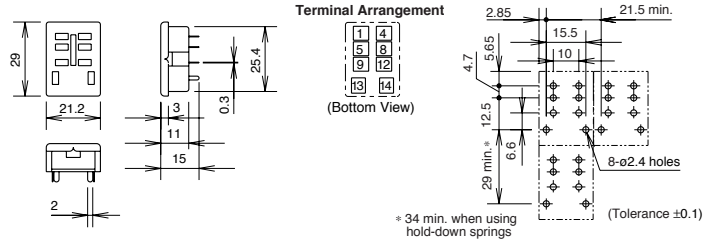

SH3B-62

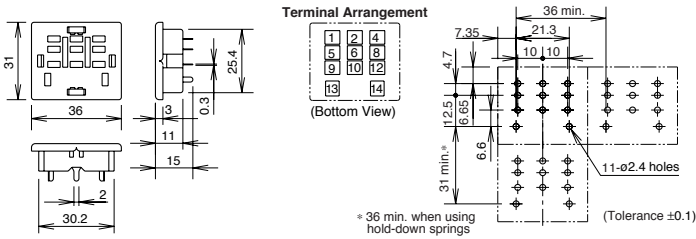

SH4B-62

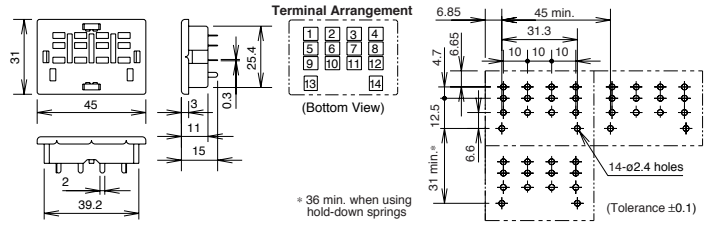

Switches & Pilot Lights

Display Lights

Relays & Sockets

Timers

Terminal Blocks

Circuit Breakers

Operating Instructions

Driving Circuit for Relays

- To ensure correct relay operation, apply rated voltage to the relay coil.
- Input voltage for the DC coil:
A complete DC voltage is best for the coil power to make sure of stable relay operation. When using a power supply containing a ripple voltage, suppress the ripple factor within 5%. When power is supplied through a rectification circuit, the relay operating characteristics, such as pickup voltage and dropout voltage, depend on the ripple factor. Connect a smoothing capacitor for better operating characteristics as shown below.

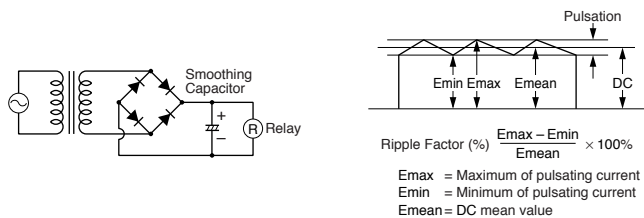

- Leakage current while relay is off:
When driving an element at the same time as the relay operation, special consideration is needed for the circuit design. As shown in the incorrect circuit below, leakage current (*I_o*) flows through the relay coil while the relay is off. Leakage current causes coil release failure or adversely affects the vibration resistance and shock resistance. Design a circuit as shown in the correct example.

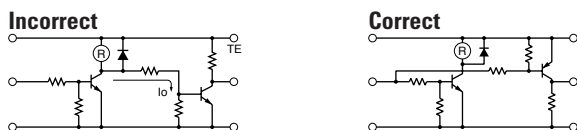

- Surge suppression for transistor driving circuits:
When the relay coil is turned off, a high-voltage pulse is generated, causing a transistor to deteriorate and sometimes to break. Be sure to connect a diode to suppress the back electromotive force. Then, the coil release time becomes slightly longer. To shorten the coil release time, connect a Zener diode between the collector and emitter of the transistor. Select a Zener voltage slightly higher than the power voltage.

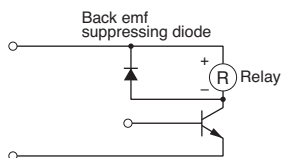

Protection for Relay Contacts

- The contact ratings show maximum values. Make sure that these values are not exceeded. When an inrush current flows through the load, the contact may become welded. If this is the case, connect a contact protection circuit, such as a current limiting resistor.
- Contact protection circuit:
When switching an inductive load, arcing causes carbides to form on the contacts, resulting in increased contact resistance. In consideration of contact reliability, contact life, and noise suppression, use of a surge absorbing circuit is recommended. Note that the release time of the load becomes slightly longer. Check the operation using the actual load. Incorrect use of a contact protection circuit will adversely affect switching characteristics. Four typical examples of contact protection circuits are shown in the following table:

RC		<p>This protection circuit can be used when the load impedance is smaller than the RC impedance in an AC load power circuit.</p> <ul style="list-style-type: none"> R: Resistor of approximately the same resistance value as the load C: 0.1 to 1 μF
Diode		<p>This protection circuit can be used for both AC and DC load power circuits.</p> <p>R: Resistor of approximately the same resistance value as the load C: 0.1 to 1 μF</p>
Diode		<p>This protection circuit can be used for DC load power circuits. Use a diode with the following ratings.</p> <p>Reverse withstand voltage: Power voltage of the load circuit x 10 Forward current: More than the load current</p>
Varistor		<p>This protection circuit can be used for both AC and DC load power circuits.</p> <p>For a best result, when using a power voltage of 24 to 48V AC/DC, connect a varistor across the load. When using a power voltage of 100 to 240V AC/DC, connect a varistor across the contacts.</p>

- Do not use a contact protection circuit as shown below:

	<p>This protection circuit is very effective in arc suppression when opening the contacts. But, the capacitor is charged while the contacts are opened. When the contacts are closed, the capacitor is discharged through the contacts, increasing the possibility of contact welding.</p>
	<p>This protection circuit is very effective in arc suppression when opening the contacts. But, when the contacts are closed, a current flows to charge the capacitor, causing contact welding.</p>

Generally, switching a DC inductive load is more difficult than switching a DC resistive load. Using an appropriate arc suppressor, however, will improve the switching characteristics of a DC inductive load.

Soldering

- When soldering the relay terminals, use a soldering iron of 30 to 60W, and quickly complete soldering (within approximately 3 seconds).
- Use a non-corrosive rosin flux.

Switches & Pilot Lights

Display Lights

Relays & Sockets

Timers

Terminal Blocks

Circuit Breakers

Operating Instructions con't

Other Precautions

1. General notice:
To maintain the initial characteristics, do not drop or shock the relay.

The relay cover cannot be removed from the base during normal operation. To maintain the initial characteristics, do not remove the relay cover.

Use the relay in environments free from condensation, dust, sulfur dioxide (SO₂), and hydrogen sulfide (H₂S).

Make sure that the coil voltage does not exceed applicable coil voltage range.
2. UL and CSA ratings may differ from product rated values determined by IDEC.
3. Do not use relays in the vicinity of strong magnetic field, as this may affect relay operation.

Safety Precautions

- Turn off the power to the relay before starting installation, removal, wiring, maintenance, and inspection of the relays. Failure to turn power off may cause electrical shock or fire hazard.
- Observe specifications and rated values, otherwise electrical shock or fire hazard may be caused.
- Use wires of the proper size to meet voltage and current requirements. Tighten the terminal screws on the relay socket to the proper tightening torque.
- Surge absorbing elements on AC relays with RC or DC relays with diode are provided to absorb the back electromotive force generated by the coil. When the relay is subject to an excessive external surge voltage, the surge absorbing element may be damaged. Add another surge absorbing provision to the relay to prevent damage.

Precautions for the RU Relays

- Before operating the latching lever of the RU relay, turn off the power to the RU relay. After checking the circuit, return the latching lever to the original position.
- Do not use the latching lever as a switch. The durability of the latching lever is a minimum of 100 operations.
- When using DC loads on 4PDT relays, apply a positive voltage to terminals of neighboring poles and a negative voltage to the other terminals of neighboring poles to prevent the possibility of short circuits.
- DC relays with a diode have a polarity in the coil terminals. Apply the DC voltage to the correct terminals.